

First Choice for Security Professionals

# HIKVISION



## PRODUCT CATALOG

201110V06



## About Us

Hikvision Digital Technology Co., Ltd. is one of the world's leading suppliers of video surveillance products and solutions. Established in 2001, Hikvision has grown from a small company with 28 people into a global enterprise with more than 5,000 employees, including 1,400 R&D engineers. With the largest R&D team in the industry and capability of continuous innovation, Hikvision's product offerings include hybrid DVRs, NVRs, standalone DVRs, digital video servers, compression cards, high-definition IP cameras and speed domes. These products are used in more than 100 countries and have been used to secure various security applications around the world.

Head quartered in Hangzhou, China, Hikvision has expanded to a global operation with regional branch offices in Los Angeles covering the Americas; Amsterdam covering Europe, and Dubai for the Middle East; joint ventures in India and Russia; as well as a maintenance center in Hong Kong.

Rapid growth and exceptional products have seen Hikvision recognized as the No.1 DVR supplier according to IMS Research's World Market for CCTV and Video Surveillance Equipment Report 2011 and listed for three years in a row in Security 50, a market survey recognizing the top 50 security vendors in the global security market (No. 10 in 2010). Hikvision is now publicly listed in Shenzhen Stock Exchange with market capitalization of US \$5.6 billion.



# INDEX

<b>About Us</b> .....	1	DS-2CC5132P(N)-IR .....	77
<b>Model Name Coding Rule</b> .....	3	DS-2CC5132P(N)-IRP .....	78
<b>Features and Benefits</b> .....	4	DS-2CZ2132P .....	79
<b>Speed Dome</b>		DS-2CZ2152P .....	80
DS-2DF1-714 .....	8	DS-2CZ282P(N) .....	81
DS-2DF1-713/715-B .....	9	DS-2CZ292P(N) .....	82
DS-2DF1-572/5702/5732 .....	10	<b>Hybrid DVR</b>	
DS-2DF1-513/515/517-B .....	11	DS-9004/08/16HFI-SH .....	84
DS-2DF1-514/516/518 .....	12	DS-9004/08/16HFI-RH .....	85
DS-2DF1-401H .....	13	DS-7604HI-S .....	86
DS-2AF1-714 .....	14	<b>Standalone DVR</b>	
DS-2AF1-713/715-B .....	15	DS-9104/08/16HFI-ST .....	87
DS-2AF1-513/515/517-B .....	16	DS-9104/08/16HWI-ST .....	88
DS-2AF1-514/516/518 .....	17	DS-8104/08/16HCI-ST .....	89
DS-2AF1-401X .....	18	DS-8104/08/16HDI-ST .....	90
<b>Network Camera</b>		DS-8104/08/16HFI-ST .....	91
DS-2CD883F-E(W) .....	20	DS-8104/08/16HWI-ST .....	92
DS-2CD854F-E(W) .....	21	DS-7304/08/16HI-ST .....	93
DS-2CD877BF .....	22	DS-7304/08/16HFI-ST .....	94
DS-2CD853F-E(W) .....	23	DS-7204/08/16HVI-ST .....	95
DS-2CD864FWD-E .....	24	DS-7204/08/16HVI-ST/SE .....	96
DS-2CD863P(N)F-E(W) .....	25	DS-7204/08/16HVI-ST/SN .....	97
DS-2CD893P(N)FWD-E(W) .....	26	DS-7204/08/16HFI-ST .....	98
DS-2CD893P(N)F-E(W) .....	27	DS-7204/08/16HFI-ST/SE .....	99
DS-2CD802/812P(N)F-E(W) .....	28	DS-7204/08/16HFI-ST/SN .....	100
DS-2CD833F-E(W) .....	29	DS-7204HVI-ST/L .....	101
DS-2CD802/812/892P(N)-IR1/IR3/IR5 .....	30	<b>NVR</b>	
DS-2CD8253F-EI(S) .....	31	DS-9604/08/16NI-SH .....	102
DS-2CD8254F-EI(S) .....	32	DS-9508/16NI-S .....	103
DS-2CD783F-E(I) .....	33	DS-7604NI-S .....	104
DS-2CD754F-E(I) .....	34	DS-7608NI-S .....	105
DS-2CD754FWD-E(I) .....	35	<b>ATM DVR</b>	
DS-2CD753F-E(I) .....	36	DS-8104/08AH(L)I-ST .....	106
DS-2CD763P(N)F-E(I) .....	37	DS-8104/08AHF(L)I-ST .....	107
DS-2CD793P(N)FWD-E(I) .....	38	<b>Mobile DVR</b>	
DS-2CD793P(N)F-E(I) .....	39	DS-8104HMI-A .....	108
DS-2CD702/712P(N)F-E .....	40	DS-8104HMI-B .....	109
DS-2CD733F-E(I) .....	41	DS-8104HMI-M .....	110
DS-2CD7153-E .....	42	DS-8104/08/12/16HMFIT .....	111
DS-2CD7133-E .....	43	DS-1004HMI .....	112
DS-2CD8153F-E .....	44	<b>Digital Video Server</b>	
DS-2CD8133F-E .....	45	DS-6601/6602/6604HFI .....	114
<b>Analog Camera</b>		DS-6601/6602/6604HFI-SATA .....	115
DS-2CC1191P-A .....	46	DS-6508/6516HCI .....	116
DS-2CC1193P(N)-A .....	47	DS-6508/6516HCI-SATA .....	117
DS-2CC1195P(N)-A .....	48	DS-6508/6516HFI .....	118
DS-2CC1197P-A .....	49	DS-6508/6516HFI-SATA .....	119
DS-2CC1198P-A .....	50	DS-6101HFI-IP-A .....	120
DS-2CC1112/1172P(-A) .....	51	IP Module .....	121
DS-2CC1192P(N)(-A) .....	52	DS-6101DI .....	122
DS-2CC176P-A(-C) .....	53	DS-6401HDI .....	123
DS-2CC102P(N)(-A) .....	54	DS-6001FI .....	124
DS-2CC5191P(N)-VF .....	55	DS-6301/04/08DI .....	125
DS-2CC5193P-VF .....	56	<b>Key Board</b>	
DS-2CC5195P(N)-VF .....	57	DS-1002KI .....	126
DS-2CC5197P-VF .....	58	DS-1003KI .....	127
DS-2CC5132P(N) .....	59	DS-1100KI .....	128
DS-2CC5112/5172P .....	60	<b>Compression Card</b>	
DS-2CC5192P(N) .....	61	DS-4004/08/16HCI .....	130
DS-2CC5102P(N) .....	62	DS-4008/4016HSI .....	131
DS-2CC5173P(N)-VP(IR)(H) .....	63	DS-4216HCI .....	132
DS-2CC5193P-VF(IR)(H) .....	64	DS-4208/4216HFVI .....	133
DS-2CC502/512/592P(N)-FB .....	65	DS-4002/4004MDI+ .....	134
DS-2CC511/591P(N)-A .....	66	<b>Camera Bracket</b> .....	135
DS-2CC102/112/192P(N)-IR .....	67	<b>Speed Dome Bracket</b> .....	138
DS-2CC102/112/192P(N)-IR3/IR5 .....	68	<b>Camera housing</b> .....	139
DS-2CC102/112/192P(N)-IRA .....	69	<b>Lens</b> .....	140
DS-2CC102/112/192P(N)-IRT .....	70		
DS-2CC1132P(N)-IR .....	71		
DS-2CC1173P-VF(IR) .....	72		
DS-2CC1192P-IRA .....	73		
DS-2CC502/572P(N)-IMB .....	74		
DS-502/512/592P(N)-IR/IR3 .....	75		
DS-2CC5192P-IR1/IR3 .....	76		

# Model Name Coding Rule

## Speed Dome

DS-2AM1-613X-B	DS-2	A	M	1-	6	1	3	X	-B
DS-2DF1-602H	DS-2	D	F	1-	6	0	2	H	
DS-2DF1-401H	DS-2	D	F	1-	4	0	1	H	
DS-2DF1-514F	DS-2	D	F	1-	5	1	4	F	
	①	②	③	④	⑤	⑥	⑦	⑧	⑨

- ① DS-2—HIKVISION front-end product
- ② A—Analog speed dome  
D—Network speed dome
- ③ F—High Speed dome  
M—Medium speed dome
- ④ 6—6 inch speed dome  
4—4 inch speed dome  
5—5 inch speed dome  
7—IR speed dome
- ⑤ 1—Standard Definition Outdoor speed dome  
0—Standard Definition Indoor speed dome  
3—Standard Definition In-ceiling speed dome  
7—1.3 Megapixel High Definition Outdoor speed dome  
70—1.3 Megapixel High Definition Indoor speed dome  
73—1.3 Megapixel High Definition In-ceiling speed dome  
8—2 Megapixel High Definition Outdoor speed dome  
80—2 Megapixel High Definition Indoor speed dome  
83—2 Megapixel High Definition In-ceiling speed dome
- ⑥ The number stands for different camera modules with different optical zoom times
- ⑦ X—Speed dome with new structure(For 4 inch and 6 inch standard definition speed dome)  
H—Speed dome support DS-9000 series NVR(For 4 inch and 6 inch standard definition speed dome)  
F—Built-in optical interface  
S—SDI interface
- ⑧ -B—Sony Drive for WDR

## Analog Camera

DS-2CC176P-C	DS-2	C	C	1	7	6	P	-C	
DS-2CC512N-IRA	DS-2	C	C	5	1	2	N	-IRA	
DS-2CC1185P-A	DS-2	C	C	1	1	9	5	P	
DS-2CC5197P-VP	DS-2	C	C	5	1	9	7	P	
	①	②	③	④	⑤	⑥	⑦	⑧	⑨

- ① "DS-2"—HIKVISION front-end product
- ② "C"—Color camera
- ③ "C"—Analog camera
- ④ Structure  
"1"—Analog box&bullet camera  
"5"—Analog dome camera
- ⑤ Generation  
"Default"—1st generation analog camera  
"1"—2nd generation analog camera
- ⑥ Horizontal resolution  
"0"—420TVL  
"1"—480TVL  
"3"—CMOS  
"7"—540TVL or 560TVL  
"8"—600TVL  
"9"—650TVL  
"A"—700TVL
- ⑦ Special features  
"3"—Support OSD menu  
"5"—Low illumination camera  
"6"—1/2" high light compensation camera  
"7"—WDR camera  
"8"—1/3" high light compensation camera
- ⑧ Signal system  
"P"—PAL signal system  
"N"—NTSC signal system
- ⑨ Extended Information  
"-VP"—Vandal proof housing  
"-VF"—Vari-focal lens  
"-A"—Support AC 24V / DC 12V  
"-C"—Support AC100V-240V  
"-IR"—Support IR  
"-IR1"—10 to 20 meters IR Range  
"-IR3"—30 to 40 meters IR Range  
"-IR5"—50 to 60 meters IR Range  
"-IRA"—100 to 110 meters IR Range  
"-IRT"—IR with vari-focal lens  
"-MM"—Mini structure  
"-PT"—Build-in PTZ  
"-IPT"—Build-in PTZ with 10 meters IR Range  
"-H"—Heater  
"-DG"—Pinhole camera  
"-BT"—Mini bullet camera  
"-FD"—UFO camera

## Zoom Camera

DS-2DZ216MF	DS-2	D	Z	2	1	6	M	F	
DS-2CM282P-WD	DS-2	C	M	2	8	2	P	-WD	
	①	②	③	④	⑤	⑥	⑦	⑧	⑨

- ① "DS-2"—HIKVISION front-end product
- ② "C"—Analog camera  
"D"—Network camera
- ③ "Z"—Zoom camera  
"M"—Zoom camera module
- ④ "2"—Zoom camera
- ⑤ "0"—10x optical zoom  
"1"—18x optical zoom  
"3"—22x optical zoom  
"5"—23x optical zoom  
"8"—30x optical zoom  
"9"—36x optical zoom
- ⑥ Different number stands for different features
- ⑦ "P"—PAL signal system  
"N"—NTSC signal system  
"M"—Mega pixels
- ⑧ "F"—Support SD/SDHC card
- ⑨ "-WD"—Wide Dynamic Range  
"-PT1"—Constant speed PTZ with 100 meters IR Range  
"-PT2"—Constant speed PTZ  
"-PT3"—Constant speed PTZ with 200 meters IR Range  
"-PT4"—Variable speed PTZ

## Network Camera

DS-2CD7133-E	DS-2	C	D	71	3	3	-E		
DS-2CD672MF-FB	DS-2	C	D	7	6	2	M		
DS-2CD8254F-EI	DS-2	C	D	82	5	4	F		
DS-2CD893PFWD-E	DS-2	C	D	8	9	3	P		
	①	②	③	④	⑤	⑥	⑦	⑧	⑨

- ① "DS-2"—HIKVISION front-end product
- ② "C"—Color camera
- ③ "D"—Network camera
- ④ "7"—Dome camera  
"8"—Box camera  
"71"—Mini dome camera  
"72"—Outdoor dome camera  
"81"—Mini cube camera  
"82"—Bullet camera  
"83"—Thermal camera
- ⑤ "3"—VGA(640x480) resolution  
"5"—2 or 3 mega pixels resolution CMOS  
"6"—1.3 mega pixels resolution  
"7"—2 mega pixels resolution  
"8"—5 mega pixels resolution  
"9"—4CIF resolution
- ⑥ Different numbers stands for different sensor, camera generation and expanded information
- ⑦ "P"—PAL signal system  
"N"—NTSC signal system  
"B"—BNC output
- ⑧ "F"—Support SD/SDHC card  
"WD"—Wide Dynamic Range  
"-IR1"—10 to 20 meters IR Range  
"-IR3"—30 to 40 meters IR Range  
"-IR5"—50 to 60 meters IR Range
- ⑨ "E"—Power over Ethernet(PoE)  
"-W"—Wi-Fi(802.11g/b/n)  
"-PT"—Build-in PTZ  
"-I"—Support IR  
"-H"—Heater

# Features and Benefits

## WDR (Wide Dynamic Range)

The WDR function is intended to provide with clear image performance in strong backlight areas such as exterior light coming through a window or glass door. High contrast light conditions are no longer a problem when you need to capture detailed images.



Conventional Camera



WDR Camera



When ICR is on, camera is able to increase highly its light sensitivity in monochrome mode.

## ICR (Infrared Cut filter Removal)

An IR filter – or IR cut filter - is a color filter blocking the infrared light. In order to avoid unwanted side-effects caused by infrared light (as part of the natural ambient light) during image recordings in daylight mode, an IR Cut Filter is installed in front of the sensor. The filter is meant to prevent the incidence of light onto the image sensor.

## BLC (Backlight Compensation)

Backlight is the light behind the object of interest in a scene. Back Light Compensation BLC automatically brings more detail to darker areas of an image when bright light shining from behind obscures it and provides perfect exposure for an object in front of very strong back light. The electronic shutter of the camera basically adjusts its exposure to try to allow for more light to be allowed in the darker areas.



Conventional Camera



With BLC



By avoiding privacy infringement issues, this function allows users selecting several sensitive areas to blocked undesirable monitoring.

## Privacy Mask

Privacy masking is a common term covering the need to restrict what can be seen by camera. It applies equally to image displayed in real time basis for surveillance purposes and image recorded for later use. This function is use to protect personal privacy by concealing part of the image from view with a masked area.

### HLC (Highlight Compensation)

It is ability to reverse bright points in the picture to black. As an effective approach to recognize vehicle's number-plate at night, HLC function can detect any spotlight diffused by object-vehicle and compensate it for obtaining clearer image.



HLC Off



HLC On



Conventional Camera



With AWB

### AWB (Automatic White Balance)

Color temperature is directly related to environment and it influences on the color of image. AWB automatically adjusts the white balance in response to varying light conditions to reproduce accurate color without any color-cast caused by different lighting source (ex. Incandescent, fluorescent and quartz light).

### Super Low Light Performance

With advanced ISP technology, Hikvision's cameras provide ultra high sensitivity allowing visibility in very dark conditions.



Conventional Camera



With ISP



Conventional Camera



With AGC

### Automatic Gain Control

It's a form of amplification where the camera will automatically boost the image received in much lower light conditions than standard in order to optimize the clarity of image in poor lit scene.

### 3D Intelligent Positioning

A easy-to-use function enabling user to track and zoom out any suspected objects by simply drag-and-click mouse.

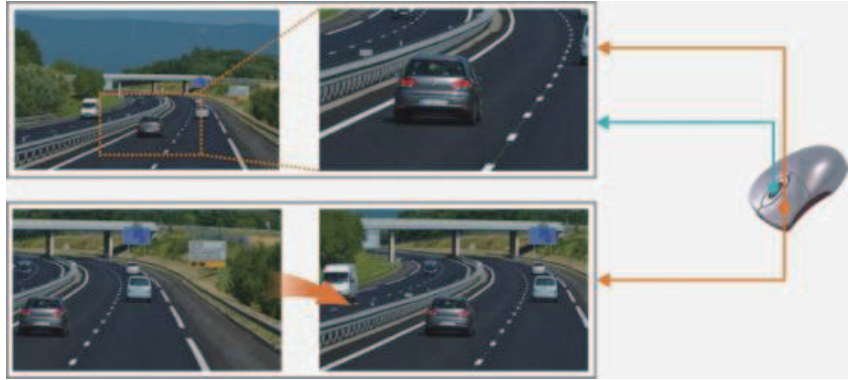

Conventional Camera



With 3D DNR

### 3D DNR (Digital Noise Reduction)

Compared to traditional DNR technology, 3D DNR can decrease the noise effect, especially when capturing moving images in low light conditions and delivering more accurate and sharp image quality.

### Smart IR

In some case of misjudging the length of IR range and subjects, IR cameras lead to frequently over-exposed subjects. That's why smart IR is there to solve this type of issue by adjusting automatically IR light and based on subject's distance, resulting in a clear image that is not washed out or too dark.



General IR Camera



Smart IR Camera

### DIS (Digital Image System)

Developed by Hikvision, this industry-advanced technology with excellent image quality, low power-consuming and high reliability, can provide a perfect cost-effective alternative to traditional analog cameras.



Conventional Camera



DIS Camera



# SPEED DOME



# DS-2DF1-714 IR Network High Speed Dome

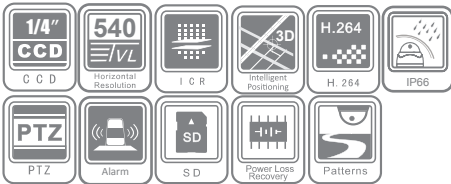

## Key Features

- 1/4" Sony Super HAD CCD
- True day / night
- 80m IR range
- 3D intelligent positioning function
- IP66 rating
- 23x optical zoom

## Dimensions

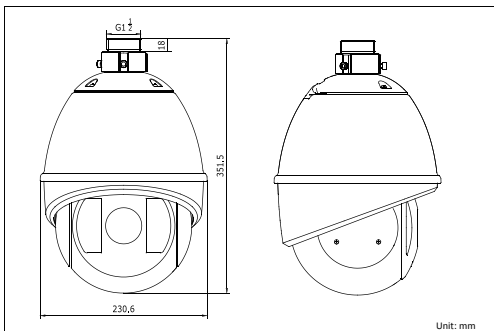

## Accessories



DS-1614ZJ  
(Long-arm Wall Mount Bracket)

DS-2DF1-714 (outdoor)	
<b>Camera</b>	
Image sensor	1/4" Sony Super HAD CCD
Effective pixel	PAL: 752 (H) × 582 (V), NTSC: 768 (H) × 494 (V)
Horizontal resolution	Color: 540 TVL, B/W: 570 TVL
Signal system	PAL / NTSC
Min. illumination	Color: 0.2 lux@F1.6, B/W: 0.02 lux@F1.6, 0 lux with IR
White balance	Auto / manual / ATW / indoor / outdoor
AGC	Auto / manual
S / N ratio	≥ 50dB
BLC	On / off
Shutter time	PAL: 1/50 - 1/10,000s, NTSC: 1/60 - 1/10,000s
Day & night	IR cut filter
Digital zoom	16x
Focus model	Auto / semi-automatic / manual
<b>Lens</b>	
Focal length	3.84 - 88.4mm, 23x
Zoom speed	Approx. 5.1s (optical Wide-Tele)
Angle of view	52.2 - 2.36° (Wide-Tele)
Min. working distance	10 - 1,200mm (Wide-Tele)
Aperture range	F1.6 - F4.5
<b>Pan and tilt</b>	
Pan range	360° endless
Pan speed	Pan manual speed: 0.1° - 160°/s, pan preset speed: 240°/s
Tilt range	-10° - 90° (auto flip)
Tilt speed	Tilt manual speed: 0.1° - 120°/s, tilt preset speed: 200°/s
Proportional zoom	Rotation speed can be adjusted automatically according to zoom multiples
Number of preset	256
Patrol	8 patrols, up to 32 presets per patrol
Pattern	4 patterns, with the recording time not less than 10 min per pattern
Power-off memory	Support
Park action	Preset / patrol / pattern / pan scan / tilt scan / random scan / frame scan / panorama scan
PTZ position display	On / Off
<b>Infrared</b>	
IR irradiation distance	80m
IR irradiation angle	Adjustable by zoom
<b>Alarm</b>	
Alarm input	2 (7 alarm inputs optional)
Alarm output	2 relay outputs, alarm response actions configurable
Alarm action	Preset, patrol, pattern, SD/SDHC card recording, relay output, notification on client
<b>Input / output</b>	
Monitor output	1.0V[p-p] / 75Ω, NTSC (or PAL) composite, BNC
Audio input	Audio input (LINE input), 2-2.4V[p-p]; output impedance: 1KΩ, ±10%
Audio output	Line level, impedance: 600Ω
<b>Network</b>	
Ethernet	10 base-T / 100 base-TX, RJ45 connector
Max. image resolution	PAL: 704 × 576, NTSC: 704 × 480
Frame rate	PAL: 25 fps (704 × 576), NTSC: 30 fps (704 × 480)
Image compression	H.264
Audio compression	G.711 / 16 kbps
Audio mode	Off / audio input / audio output
Protocols	TCP/IP, HTTP, DHCP, DNS, RTP / RTCP, PPPoE
No. of simultaneous users	Up to 6 users
Dual streams	Support
Mini SD memory card	Manual REC / alarm REC. Built-in SD/SDHC slot, up to 32GB
User/Host level	3 levels: administrator, camera control, live view only
Security measures	User authentication (ID and PW), host authentication (MAC address)
<b>Client GUI</b>	
Camera control	Pan / tilt, zoom, focus, click centering, drag zoom, iris, preset position call and program, auto mode.
Camera name	Up to 18 characters
Date & Time display	Time: week: date, 6 formats on the client
Reading patrol message	Display and reading of preset message contained in each patrol via client software
<b>Fiber interface (available for fiber dome only)</b>	
Data mode	10 base-T / 100 base-TX
Physical interface	FC (SC optional)
Fiber wavelength	TX1310 / RX1550nm
Fiber type	Single fiber / single mode
Transmission distance	20km, with 40km, 60km and 80km optional
<b>General</b>	
Menu language	English, Chinese
RS-485 protocols	HIKVISION, Pelco-P, Pelco-D, self-adaptive
Power supply	24V AC (12V DC optional)
Power consumption	40W max
Working temperature / humidity	-30 °C ~ 65 °C (-22 °F ~ 149 °F), 90% or less
Protection level	IP66 standard, TVS 3,000V lightning protection, surge protection and voltage transient protection
Mounting	Various mounting modes optional
Dimensions	Φ230.6 × 351.5mm (Φ 9.08" × 13.84")
Weight (approx.)	5.5kg (12.13lbs)

# DS-2DF1-713/715-B IR WDR Network High Speed Dome

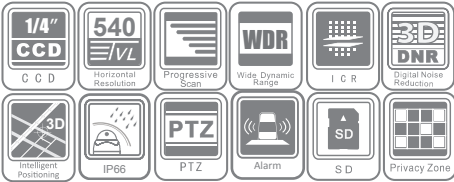

## Key Features

- 1/4" Sony EXVIEW HAD progressive scan CCD
- 128x wide dynamic range
- True day / night
- 80m IR range
- 3D intelligent positioning function
- 3D digital noise reduction
- IP66 rating

## Dimensions

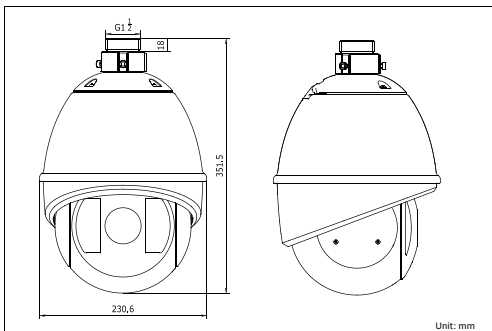

## Accessories



DS-1614ZJ  
(Long-arm Wall Mount Bracket)

	DS-2DF1-713-B (outdoor)	DS-2DF1-715-B (outdoor)
<b>Camera</b>		
Image sensor	1/4" Sony EXVIEW HAD progressive scan CCD	
Effective pixel	PAL: 752 (H) × 582 (V), NTSC: 768 (H) × 494 (V)	
Horizontal resolution	Color: 540 TVL, B/W: 570 TVL	
Signal system	PAL / NTSC	
Min. illumination	Color: 0.7 lux@F1.4, B/W: 0.01 lux@F1.4, 0 lux with IR	Color: 0.25 lux@F1.35, B/W: 0.0015 lux@F1.35, 0 lux with IR
White balance	Auto / manual / ATW / indoor / outdoor	
AGC	Auto / manual	
S / N ratio	≥ 50dB	
BLC	On / Off	
WDR	128x (on / off / auto)	
Anti-shake	—	On / off
Shutter time	PAL: 1/3 ~ 1/10,000s, NTSC: 1/4 ~ 1/10,000s	
Day & night	IR cut filter	
Digital zoom	12x	
Privacy mask	24 privacy masks programmable; a maximum of 8 zones can be masked simultaneously on the same video screen	
Focus model	Auto / semi-automatic / manual	
<b>Lens</b>		
Focal length	4.1 ~ 73.8mm, 18x	3.5 ~ 98mm, 28x
Zoom speed	Approx.2.0s (optical Wide-Tele)	Approx.1.7s (optical Wide-Tele)
Angle of view	48 ~ 2.8° (Wide-Tele)	55.8 ~ 2.1° (Wide-Tele)
Min. working distance	290 ~ 800mm (Wide-Tele)	10 ~ 1,500mm (Wide-Tele)
Aperture range	F1.4 ~ F3.0	F1.35 ~ F3.7
<b>Pan and tilt</b>		
Pan range	360° endless	
Pan speed	Pan manual speed: 0.1° ~ 160°/s, pan preset speed: 240°/s	
Tilt range	-10° ~ 90° (auto flip)	
Tilt speed	Tilt manual speed: 0.1° ~ 120°/s, tilt preset speed: 200°/s	
Proportional zoom	Rotation speed can be adjusted automatically according to zoom multiples	
Number of preset	256	
Patrol	8 patrols, up to 32 presets per patrol	
Pattern	4 patterns, with the recording time not less than 10 min per pattern	
Power-off memory	Support	
Park action	Preset / patrol / pattern / pan scan / tilt scan / random scan / frame scan / panorama scan	
PTZ position display	On / off	
Freeze frame	Support	
<b>Infrared</b>		
IR irradiation distance	80m	
IR irradiation angle	Adjustable by zoom	
<b>Alarm</b>		
Alarm input	2 (7 alarm inputs optional)	
Alarm output	2 relay outputs, alarm response actions configurable	
Alarm action	Preset, patrol, pattern, SD/SDHC card recording, relay output, notification on client	
<b>Input/ Output</b>		
Monitor output	1.0V[p-p] / 75Ω, NTSC (or PAL) composite, BNC	
Audio input	Audio input (LINE input), 2-2.4V[p-p]; output impedance: 1KΩ, ±10%	
Audio output	Line level, impedance: 600Ω	
<b>Network</b>		
Ethernet	10 base-T / 100 base-TX	
Max. image resolution	PAL: 704 × 576, NTSC: 704 × 480	
Frame rate	PAL: 25fps (704 × 576), NTSC: 30fps (704 × 480)	
Image compression	H.264	
Audio compression	G.711 / 16kbps	
Audio mode	Off / audio input / audio output	
Protocols	TCP/IP, HTTP, DHCP, DNS, RTP / RTCP, PPPoE	
No. of simultaneous users	Up to 6 users	
Dual streams	Support	
Mini SD memory card	Manual REC / alarm REC. Built-in SD/SDHC slot, up to 32GB	
User / Host level	3 levels: administrator, camera control, live view only	
Security measures	User authentication (ID and PW), host authentication (MAC address)	
<b>Client GUI</b>		
Camera control	Pan / tilt, zoom, focus, click centering, drag zoom, iris, preset position call and program, auto mode.	
Camera name	Up to 18 characters	
Date & time display	Time: week: date, 6 formats on the client	
Reading patrol message	Display and reading of preset message contained in each patrol via client software	
<b>Fiber interface (available for fiber dome only)</b>		
Data mode	10 base-T / 100 base-TX	
Physical interface	FC (SC optional)	
Fiber wavelength	TX1310 / RX1550nm	
Fiber type	Single fiber / single mode	
Transmission distance	20km, with 40km, 60km and 80km optional	
<b>General</b>		
Menu language	English, Chinese	
RS-485 protocols	HIKVISION, Pelco-P, Pelco-D, self-adaptive	
Power supply	24 VAC (12 VDC optional)	
Power consumption	40W max	
Working temperature / humidity	-30 °C ~ 65 °C (-22 °F ~ 149 °F), 90% or less	
Protection level	IP66 standard, TVS 3,000V lightning protection, surge protection and voltage transient protection	
Mounting	Various mounting modes optional	
Dimensions	Φ230.6 × 351.5mm (Φ9.08" × 13.84")	
Weight (approx.)	5.5kg (12.13lbs)	

# DS-2DF1-572/5702/5732

# 1.3 MP Network High Speed Dome

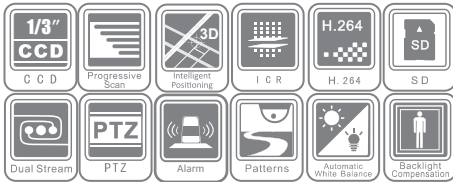

## Key Features

- 1/3" Sony progressive scan CCD
- True day / night
- Up to 1.3 megapixel resolution
- 3D intelligent positioning function
- Powerful PTZ control
- Programmable alarm triggering
- IP66 rating
- 18x optical zoom

## Dimensions

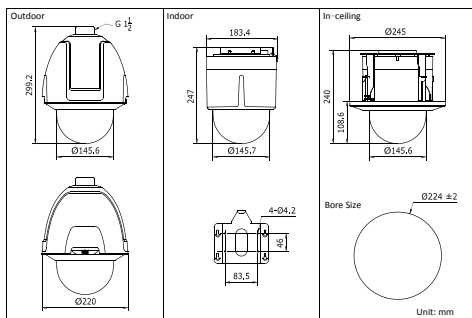

## Accessories



DS-1614ZJ  
(Long-arm Wall Mount Bracket)

DS-2DF1-572 (outdoor) DS-2DF1-5702 (indoor) DS-2DF1-5732 (in-ceiling)	
<b>Camera</b>	
Image sensor	1/3" Sony progressive scan CCD
Effective pixel	1280 (H) × 960 (V)
Min. illumination	Color: 0.5 lux@F1.6, B/W: 0.02 lux@F1.6
White balance	Auto / manual / one touch WB / ATW
AGC	Auto / manual
S/N ratio	≥ 50dB
BLC	On / Off
Shutter time	1/25 ~ 1/100,000s
Day & night	IR cut filter
Digital zoom	12x
Focus model	Auto / semi-automatic / manual
<b>Lens</b>	
Focal length	4.7 ~ 84.6mm, 18x
Zoom speed	Approx.2s (optical Wide-Tele)
Angle of view	55.2 ~ 3.2° (Wide-Tele)
Min. working distance	10 ~ 1,500mm (Wide-Tele)
Aperture range	F1.6 ~ F2.8
<b>Pan and tilt</b>	
Pan range	360° endless
Pan speed	Pan manual speed: 0.1° ~ 400°/s, pan preset speed: 540°/s
Tilt range	-5° ~ 90° (auto flip)
Tilt speed	Tilt manual speed: 0.1° ~ 240°/s, tilt preset speed: 400°/s
Proportional zoom	Rotation speed can be adjusted automatically according to zoom multiples
Number of preset	256
Patrol	8 patrols, up to 32 presets per patrol
Pattern	4 patterns, with the recording time not less than 10 min per pattern
Power-off memory	Support
Park action	Preset / patrol / pattern / pan scan / tilt scan / random scan / frame scan / panorama scan
PTZ position display	On / off
Freeze frame	Support
<b>Alarm</b>	
Alarm input	1
Alarm output	1 relay outputs, alarm response actions configurable
Alarm actions	Preset, patrol, pattern, SD/SDHC card recording, relay output, notification on client
<b>Input / output</b>	
Monitor output	1.0V[p-p] / 75Ω, NTSC (or PAL) composite, BNC
Audio input	Audio input (LINE input), 2-2.4V[p-p]; output impedance: 1KΩ, ±10%
Audio output	Line level, impedance: 600Ω
<b>Network</b>	
Ethernet	10 base-T / 100 base-TX, RJ45 connector
Max. image resolution	1280 × 960
Frame rate	50Hz: 25 fps (1280 × 720)
Image compression	H.264
Audio compression	G.711 / 16kbps
Audio mode	Off / audio input / audio output
Protocols	TCP/IP, HTTP, DHCP, DNS, RTP / RTCP, PPPoE
No. of simultaneous users	Up to 6 users
Dual streams	Support
Mini SD memory card	Manual REC / alarm REC. Built-in SD/SDHC slot, up to 32GB
User / host level	3 levels: administrator, camera control, live view only
Security measures	User authentication (ID and PW), host authentication (MAC address)
<b>Client GUI</b>	
Camera control	Pan / tilt, zoom, focus, click centering, drag zoom, iris, preset position call and program, auto mode.
Camera name	Up to 18 characters
Date & time display	Time: week: date, 6 formats on the client
Reading patrol message	Display and reading of preset message contained in each patrol via client software
<b>Fiber interface (available for fiber dome only)</b>	
Data mode	10 base-T / 100 base-TX
Physical interface	FC / SC optional
Fiber wavelength	TX1310 / RX1550nm
Fiber type	Single fiber / single mode
Transmission distance	20km, 40km / 60km / 80km optional
<b>General</b>	
Menu language	English, Chinese
RS-485 protocols	HIKVISION, Pelco-P, Pelco-D, self-adaptive
Power supply	24 VAC (12 VDC optional)
Power consumption	15W max. (30W max. with heater, outdoor dome)
Working temperature / humidity	-30 °C ~ 65 °C (-22 °F ~ 149 °F) (outdoor) / -10 °C ~ 50 °C (14 °F ~ 122 °F) (indoor), 90% or less
Protection level	IP66 standard (outdoor), TVS 3,000V lightning protection, surge protection and voltage transient protection
Mounting	Various mounting modes optional
Dimensions	Φ 220 × 298.2mm (Φ 8.66"×11.78") (outdoor), Φ 183.4 × 247mm (Φ 7.22"×9.72") (indoor), Φ 245 × 240mm (Φ 9.65"×9.45") (in-ceiling)
Weight (approx.)	5kg (11.02lbs)

# DS-2DF1-513/515/517-B DS-2DF1-503/505/507-B

## WDR Network High Speed Dome

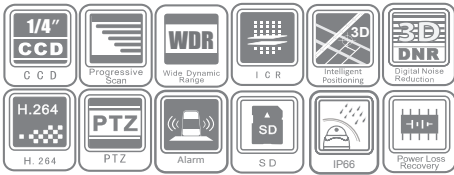

### Key Features

- 1/4" SONY EXVIEW HAD progressive scan CCD
- True day / night
- 128x wide dynamic range
- 3D intelligent positioning function
- 3D noise reduction
- Programmable alarm triggering
- IP66 rating

	DS-2DF1-513-B (outdoor) DS-2DF1-503-B (indoor) DS-2DF1-533-B (in-ceiling)	DS-2DF1-515-B (outdoor) DS-2DF1-505-B (indoor) DS-2DF1-535-B (in-ceiling)	DS-2DF1-517-B (outdoor) DS-2DF1-507-B (indoor) DS-2DF1-537-B (in-ceiling)
<b>Camera</b>			
Image sensor	1/4" Sony EXVIEW HAD progressive scan CCD		
Effective pixel	PAL: 752 (H) × 582 (V), NTSC: 768 (H) × 494 (V)		
Horizontal resolution	Color: 540 TVL, B/W: 570 TVL		
Signal system	PAL / NTSC		
Min. illumination	Color: 0.7 lux@F1.4, B/W:0.01 lux@F1.4	Color: 0.65 lux@F1.35, B/W: 0.005 lux@F1.35	Color: 1.4 lux@F1.6, B/W: 0.01 lux@F1.6
White balance	Auto / manual / ATW / indoor / outdoor		
AGC	Auto / manual		
S/N ratio	≥ 50dB		
BLC	On / off		
WDR	128x (On / off / auto)		
Anti-shake	—	On / Off	On / Off
Shutter time	PAL:1/3 - 1/10,000s, NTSC:1/4 - 1/10,000s		
Day & night	IR cut filter		
Digital zoom	12x		
Privacy mask	24 privacy masks programmable; a maximum of 8 zones can be masked simultaneously on the same video screen		
Focus model	Auto / semi-automatic / manual		
<b>Lens</b>			
Focal length	4.1 - 73.8mm, 18x	3.5 - 98mm, 28x	3.4 - 122.4mm, 36x
Zoom speed	Approx.2.0s (optical Wide-Tele)	Approx.1.7s (optical Wide-Tele)	Approx.2.7s (optical Wide-Tele)
Angle of view	48 - 2.8° (Wide-Tele)	55.8 - 2.1° (Wide-Tele)	57.8 - 1.7° (Wide-Tele)
Min. working distance	290 - 800mm (Wide-Tele)	10 - 1,500mm (Wide-Tele)	320 - 1,500mm (Wide-Tele)
Aperture range	F1.4 - F3.0	F1.35 - F3.7	F1.6 - F4.5
<b>Pan and tilt</b>			
Pan range	360° endless		
Pan speed	Pan manual speed: 0.1° -400°/s, pan preset speed: 540°/s		
Tilt range	-5°-185° (auto mirror)		
Tilt speed	Tilt manual speed: 0.1°-240°/s, tilt preset speed: 400°/s		
Proportional zoom	Rotation speed can be adjusted automatically according to zoom multiples		
Number of preset	256		
Patrol	8 patrols, up to 32 presets per patrol		
Pattern	4 patterns, with the recording time not less than 10 min per pattern		
Power loss recovery	Support		
Park action	Preset / patrol / pattern / pan scan / tilt scan / random scan / frame scan / panorama scan		
PTZ position display	On / off		
Freeze frame	Support		
<b>Alarm</b>			
Alarm input	2 (7 alarm inputs optional)		
Alarm output	2 relay outputs, alarm response actions configurable		
Alarm actions	Preset, patrol, pattern, SD card recording, relay output, notification on client		
<b>Input / output</b>			
Monitor output	1.0V[p-p] / 75Ω, NTSC (or PAL) composite, BNC		
Audio input	Audio input (LINE input), 2-2.4V[p-p]; output impedance: 1KΩ, ±10%		
Audio output	Line level, impedance: 600Ω		
<b>Network</b>			
Ethernet	10 base-T / 100 base-TX, RJ45 connector		
Max. image resolution	PAL: 704×576, NTSC: 704×480		
Frame rate	PAL : 25 fps (704×576), NTSC: 30 fps (704×480)		
Image compression	H.264		
Audio compression	G.711 / 16kbps		
Audio mode	Off / audio input / audio output		
Protocols	TCP/IP, HTTP, DHCP, DNS, RTP / RTCP, PPPoE		
No. of simultaneous users	Up to 6 users		
Dual streams	Support		
Mini SD memory card	Manual REC / alarm REC, built-in SD/SDHC slot, up to 32GB		
User / host level	3 levels: administrator, camera control, live view only		
Security measures	User authentication (ID and PW), host authentication (MAC address)		
<b>Client GUI</b>			
Camera control	Pan / tilt, zoom, focus, click centering, drag zoom, iris, preset position call and program, auto mode.		
Camera name	Up to 18 characters		
Date & time display	Time: week: date, 6 formats on the client		
Reading patrol message	Display and reading of preset message contained in each patrol via client software		
<b>Fiber interface (available for fiber dome only)</b>			
Data mode	10 base-T / 100 base-TX		
Physical interface	FC (SC optional)		
Fiber wavelength	TX1310 / RX1550nm		
Fiber type	Single fiber / single mode		
Transmission distance	20km, 40km / 60km / 80km optional		
<b>General</b>			
Menu language	English, Chinese		
RS-485 protocols	HIKVISION, Pelco-P, Pelco-D, self-adaptive		
Power supply	24 VAC (12 VDC optional)		
Power consumption	15W max. (30W max. with heater, outdoor dome)		
Working temperature / humidity	-30°C ~ 65°C (-22°F ~ 149°F) (outdoor) / -10°C ~ 50°C (14°F ~ 122°F) (indoor), 90% or less		
Protection level	IP66 standard (outdoor), TVS 3,000V lightning protection, surge protection and voltage transient protection		
Mounting	Various mounting modes optional		
Dimensions	Φ220×299.2mm (Φ 8.66"×11.78") (outdoor), Φ 183.4×247mm (Φ 7.22"×9.72") (indoor), Φ 245×240mm (Φ 9.65"×9.45") (in-ceiling)		
Weight (approx.)	5kg (11.02lbs)		

### Dimensions

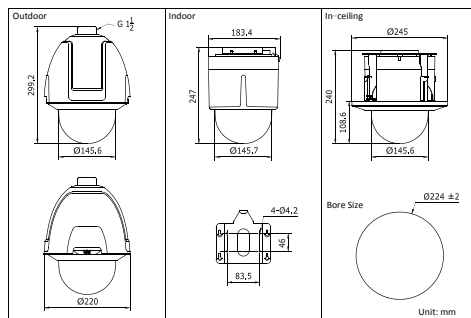

### Accessories



DS-1614ZJ  
(Long-arm Wall Mount Bracket)

# DS-2DF1-514/516/518 DS-2DF1-504/506/508

# Network High Speed Dome

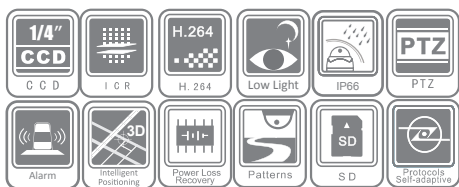

## Key Features

- 1/4" Sony Super HAD CCD
- True day / night
- H.264 video compression
- 3D intelligent positioning function
- Powerful PTZ control
- Programmable alarm triggering
- IP66 rating
- Up to 36x optical zoom

## Dimensions

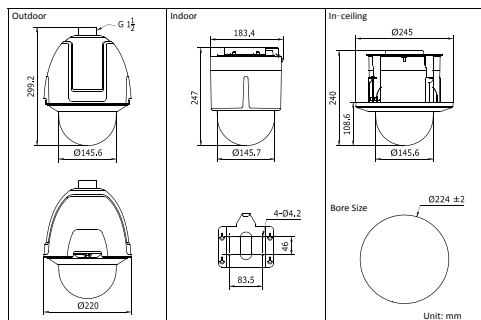

## Accessories



DS-1614ZJ  
(Long-arm Wall Mount Bracket)

	DS-2DF1-514 (outdoor) DS-2DF1-504 (indoor) DS-2DF1-534 (in-ceiling)	DS-2DF1-516 (outdoor) DS-2DF1-506 (indoor) DS-2DF1-536 (in-ceiling)	DS-2DF1-518 (outdoor) DS-2DF1-508 (indoor) DS-2DF1-538 (in-ceiling)
<b>Camera</b>			
Image sensor	1/4" Sony Super HAD CCD		
Effective pixel	PAL: 752 (H) × 582 (V), NTSC: 768 (H) × 494 (V)		
Horizontal resolution	Color: 540 TVL, B/W: 570 TVL	Color: 540 TVL, B/W: 570 TVL	Color: 540 TVL, B/W: 570 TVL
Signal system	PAL / NTSC		
Min. illumination	Color: 0.2 lux@F1.6, B/W: 0.02 lux@F1.6	Color: 0.2 lux@F1.4, B/W: 0.02 lux@F1.4	Color: 0.2 lux@F1.6, B/W: 0.02 lux@F1.6
White balance	Auto / manual / ATW / indoor / outdoor		
AGC	Auto / manual		
S/N ratio	≥ 50dB		
BLC	On / off		
Shutter time	PAL:1/50 ~ 1/10,000s, NTSC:1/60 ~ 1/10,000s	PAL:1 ~ 1/10,000s, NTSC:1 ~ 1/10,000s	PAL:1 ~ 1/10,000s, NTSC:1 ~ 1/10,000s
Day & night	IR cut filter		
Digital zoom	16x		
Focus model	Auto / semi-automatic / manual		
<b>Lens</b>			
Focal length	3.84 ~ 88.4 mm, 23x	3.5 ~ 105mm, 30x	3.4 ~ 122.4mm, 36x
Zoom speed	Approx.5.1s (optical Wide-Tele)	Approx.5.4s (optical Wide-Tele)	Approx.5.4s (optical Wide-Tele)
Angle of view	52.2 ~ 2.36° (Wide-Tele)	56.4 ~ 2.0° (Wide-Tele)	57.8 ~ 1.7° (Wide-Tele)
Min. working distance	10 ~ 1,200mm (Wide-Tele)	10 ~ 1,000mm (Wide-Tele)	10 ~ 1,000mm (Wide-Tele)
Aperture range	F1.6 ~ F4.5	F1.4 ~ F3.7	F1.6 ~ F4.5
<b>Pan and tilt</b>			
Pan range	360° endless		
Pan speed	Pan manual speed: 0.1° ~ 400°/s, pan preset speed: 540°/s		
Tilt range	-5° ~ 90° (auto flip)	-5° ~ 185° (Auto Mirror)	-5° ~ 185° (Auto Mirror)
Tilt speed	Tilt manual speed: 0.1° ~ 240°/s, tilt preset speed: 400°/s		
Proportional zoom	Rotation speed can be adjusted automatically according to zoom multiples		
Number of preset	256		
Patrol	8 patrols, up to 32 presets per patrol		
Pattern	4 patterns, with the total recording time not less than 10 min		
Power loss recovery	Support		
Park action	Preset / patrol / pattern / pan scan / tilt scan / random scan / frame scan / panorama scan		
PTZ position display	On / off		
Freeze frame	—	Support	Support
<b>Alarm</b>			
Alarm input	2 (7 alarm inputs optional)		
Alarm output	2 relay outputs, alarm response actions configurable		
Alarm action	Preset / patrol / pattern / pan scan / tilt scan / random scan / frame scan / panorama scan / relay output		
<b>Input/output</b>			
Monitor output	1.0V[p-p] / 75Ω, NTSC (or PAL) composite, BNC		
Audio input	Audio input (LINE input), 2-2.4V[p-p]; output impedance: 1KΩ, ±10%		
Audio output	Line level, impedance: 600Ω		
<b>Network</b>			
Ethernet	10 base-T / 100 base-TX, RJ45 connector		
Max. image resolution	PAL: 704 × 576, NTSC: 704 × 480		
Frame rate	PAL: 25 fps (704 × 576), NTSC: 30 fps (704 × 480)		
Image compression	H.264		
Audio compression	G.711 / 16kbps		
Audio mode	Off / audio input / audio output		
Protocols	TCP/IP, HTTP, DHCP, DNS, RTP / RTCP, PPPoE		
No. of simultaneous users	Up to 6 users		
Dual streams	Support		
Mini SD memory card	Manual REC / alarm REC. Built-in SD/SDHC slot, up to 32GB		
User / host level	3 levels: administrator, camera control, live view only		
Security measures	User authentication (ID and PW), host authentication (MAC address)		
<b>Client GUI</b>			
Camera control	Pan / tilt, zoom, focus, click centering, drag zoom, iris, preset position call and program, auto mode.		
Camera name	Up to 18 characters		
Date & time display	Time: week: date, 6 formats on the client		
Reading patrol message	Display and reading of preset message contained in each patrol via client software		
<b>Fiber interface (available for fiber dome only)</b>			
Data mode	10 base-T / 100 base-TX		
Physical interface	FC (SC optional)		
Fiber wavelength	TX1310 / RX1550nm		
Fiber type	Single fiber / single mode		
Transmission distance	20km, with 40km, 60km and 80km optional		
<b>General</b>			
Menu language	English, Chinese		
RS-485 protocols	HIKVISION, Pelco-P, Pelco-D, self-adaptive		
Power supply	24 VAC (12 VDC optional)		
Power consumption	15W max. (30W max. with heater, outdoor dome)		
Working temperature / humidity	-30°C ~ 65°C (-22°F ~ 149°F) (outdoor) / -10°C ~ 50°C (14°F ~ 122°F) (indoor), 90% or less		
Protection level	IP66 standard (outdoor), TVS 3,000V lightning protection, surge protection and voltage transient protection		
Mounting	Various mounting modes optional		
Dimensions	Φ 220×299.2mm (Φ 8.66"×11.78") (outdoor), Φ 183.4×247mm (Φ 7.22"×9.72") (indoor), Φ 245×240mm (Φ 9.65"×9.45") (in-ceiling)		
Weight (approx.)	5kg (11.02lbs)		

# DS-2DF1-401H Indoor Network High Speed Dome

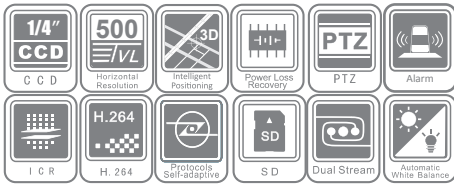

## Key Features

- 1/4" Interline Transfer Sony CCD
- 500 TVL resolution
- True day / night
- 3D intelligent positioning function
- Powerful PTZ control
- Programmable alarm triggering
- 10x optical zoom

## Dimensions

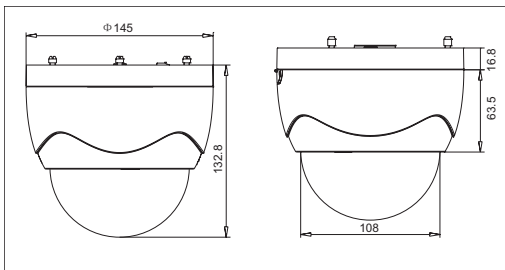

## Accessories



DS-2DF1-401H	
<b>Camera</b>	
Image sensor	1/4" Interline Transfer SONY CCD
Effective pixel	PAL: 752 (H) × 582 (V), NTSC: 768 (H) × 494 (V)
Horizontal resolution	Color: 500 TVL, B/W: 570 TVL
Signal system	PAL / NTSC
Min.illumination	Color: 0.7 lux@F1.8, B/W: 0.02 lux@F1.8
White balance	Auto / manual / ATW / indoor / outdoor
AGC	Auto / manual
S/N ratio	≥ 50dB
BLC	On / Off
Shutter time	PAL: 1/4 ~ 1/10,000s, NTSC: 1/3 ~ 1/10,000s
Day & night	IR cut filter
Digital zoom	10x
Privacy mask	4 privacy masks programmable; a maximum of 4 zones can be masked simultaneously on the same video screen
Focus model	Auto / semi-automatic / manual
<b>Lens</b>	
Focal length	3.8 ~ 38mm, 10x
Zoom speed	Approx.1.7s (optical Wide-Tele)
Angle of view	51.2 ~ 5.58° (Wide-Tele)
Min. working distance	10 ~ 1,000mm (Wide-Tele)
Aperture range	F1.8 ~ F2.8
<b>Pan and tilt</b>	
Pan range	360° endless
Pan speed	Pan manual speed: 0.1° ~ 300°/s, Pan preset speed: 400°/s
Tilt range	-2° ~ 90° (auto flip )
Tilt speed	Tilt manual speed: 0.1° ~ 90°/s, Tilt preset speed: 200°/s
Proportional zoom	Rotation speed can be adjusted automatically according to zoom multiples
Number of preset	256
Patrol	8 patrols, up to 32 presets per patrol
Pattern	4 patterns, with the total recording time not less than 10 min
Power loss recovery	Support
Park action	Preset / patrol / pattern / pan scan / tilt scan / random scan / frame scan / panorama scan
PTZ position display	On / off
Freeze frame	Support
<b>Alarm</b>	
Alarm input	1
Alarm output	1 relay outputs, alarm response actions configurable
Alarm action	Preset, patrol, pattern, SD card recording, relay output, notification on client
<b>Input / output</b>	
Monitor output	1.0V[p-p] / 75Ω, NTSC (or PAL) composite, BNC
Audio input	Audio input (LINE input), 2-2.4V[p-p]; output impedance: 1KΩ, ±10%
Audio output	Line level, impedance: 600Ω
<b>Network</b>	
Ethernet	10 base-T / 100 base-TX, RJ45 connector
Max.image resolution	PAL: 704 × 576, NTSC: 704 × 480
Frame rate	PAL: 25 fps (704 × 576), NTSC: 30 fps (704 × 480)
Image compression	H.264
Audio compression	G.711 / 16kbps
Audio mode	Off / audio input / audio output
Protocols	TCP/IP, HTTP, DHCP, DNS, RTP / RTCP, PPPoE
No. of simultaneous users	Up to 6 users
Dual streams	Support
Mini SD memory card	Manual REC / alarm REC. Built-in SD/SDHC slot, up to 32GB
User / host Level	3 levels: administrator, camera control, live view only
Security measures	User authentication (ID and PW), host authentication (MAC address)
<b>Client GUI</b>	
Camera control	Pan / tilt, zoom, focus, click centering, drag zoom, iris, preset position call and program, auto mode.
Camera name	Up to 18 characters
Date & time display	Time: week: date, 6 formats on the client
Reading patrol message	Display and reading of preset message contained in each patrol via client software
<b>General</b>	
Menu language	English, Chinese
RS-485 protocols	HIKVISION, Pelco-P, Pelco-D, self-adaptive
Power supply	12 VDC / PoE
Power consumption	12W max.
Working temperature / humidity	-10°C ~ 50°C (14°F ~ 122°F) (indoor), 90% or less
Mounting	Various mounting modes optional
Dimensions	Φ 145 × 132.8mm (Φ 5.71" × 5.23") (indoor)
Weight (approx.)	2kg (4.41lbs)

# DS-2AF1-714 IR Analog High Speed Dome

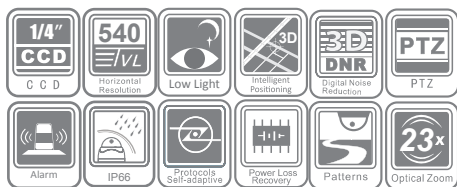

## Key Features

- 1/4" Sony Super HAD CCD
- Low illumination
- True day / night
- 80m IR range
- 3D digital noise reduction
- IP66 rating
- 23x optical zoom

## Dimensions

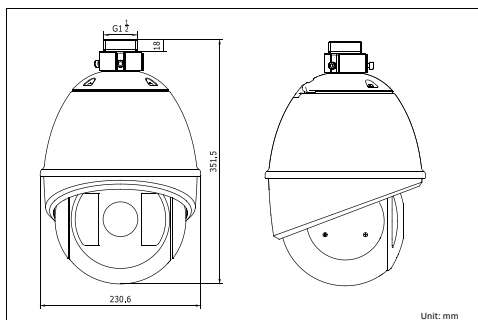

## Accessories



DS-1614ZJ  
(Long-arm Wall Mount Bracket)

DS-2AF1-714	
<b>Camera</b>	
Image sensor	1/4" Sony Super HAD CCD
Effective pixel	PAL: 752 (H) × 582 (V), NTSC: 768 (H) × 494 (V)
Horizontal resolution	Color: 540 TVL, B/W: 570 TVL
Signal system	PAL / NTSC
Min.illumination	Color: 0.2 lux@F1.6, B/W: 0.02 lux@F1.6 , 0 lux with IR
White balance	Auto / manual / ATW / indoor / outdoor
AGC	Auto / manual
S/N ratio	≥ 50dB
BLC	On / off
Shutter time	PAL: 1/50 ~ 1/10,000s , NTSC: 1/60 ~ 1/10,000s
Day & night	IR cut filter
Digital zoom	16x
Focus model	Auto / semi-automatic / manual
<b>Lens</b>	
Focal length	3.84 ~ 88.4 mm, 23x
Zoom speed	Approx.5.1s (optical Wide-Tele)
Angle of view	52.2 ~ 2.36° (Wide-Tele)
Min. working distance	10 ~ 1,200mm (Wide-Tele)
Aperture range	F1.6 ~ F4.5
<b>Pan and tilt</b>	
Pan range	360° endless
Pan speed	Pan manual speed: 0.1° ~ 160°/s, pan preset speed: 240°/s
Tilt range	-10° ~ 90° (auto flip )
Tilt speed	Tilt manual speed: 0.1° ~ 120°/s, tilt preset speed: 200°/s
Proportional zoom	Rotation speed can be adjusted automatically according to zoom multiples
Number of preset	256
Patrol	8 patrols, up to 32 presets per patrol
Pattern	4 patterns, with the total recording time not less than 10 min
Power loss recovery	Support
Park action	Preset / patrol / pattern / pan scan / tilt scan / random scan / frame scan / panorama scan
PTZ position display	On / off
Password protection	Support
Zone scanning / display	Scanning within programmed zone, display zone title
Camera title	Programmable title display
Compass	Support , the north can be set
Scheduled task	Preset / patrol / pattern / pan scan / tilt scan / random scan / frame scan / panorama scan
RS-485 communication diagnosis	Including failure information, e.g., wrong address, baud rate errors, et., displayed on the video screen in text
Manchester code communication diagnosis	Including failure information, e.g., wrong address, baud rate errors s displayed on the video screen in special characters
<b>Infrared</b>	
IR range	80m
IR irradiation angle	Adjustable by zoom
<b>Alarm</b>	
Alarm input	2 (additional wires required)
Alarm output	2 relay outputs, alarm response actions configurable (additional wires required)
Alarm action	Preset / patrol / pattern / pan scan / tilt scan / random scan / frame scan / panorama scan / relay output
<b>Input/ output</b>	
Monitor output	1.0V(p-p) / 75Ω, NTSC (or PAL) composite, BNC
<b>Fiber interface (available for fiber dome only)</b>	
Data mode	1-channel analog video and 1-channel reverse RS-485 data
Physical interface	FC (SC optional)
Fiber wavelength	TX1310 / RX1550nm
Fiber type	Single fiber / single mode
Transmission distance	20km, 40km / 60km / 80km optional
<b>General</b>	
Menu language	English, Chinese
RS-485 protocols	HIKVISION, Pelco-P, Pelco-D, self-adaptive
Power supply	24 VAC (12 VDC optional)
Power consumption	40W max.
Working temperature / humidity	-30°C ~ 65°C (-22°F ~ 149°F), 90% or less
Protection level	IP66 standard, TVS 3,000V lightning protection, surge protection and voltage transient protection
Mounting	Various mounting modes optional
Dimensions	Φ230.6 × 351.5mm (Φ9.08" × 13.84" )
Weight (approx.)	5.5kg (12.13lbs)



# DS-2AF1-713/715-B IR WDR Analog High Speed Dome

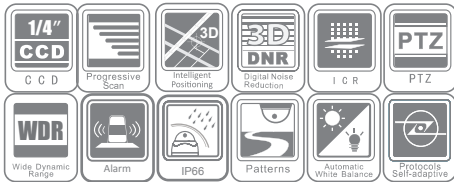

## Key Features

- 1/4" Sony EXVIEW HAD progressive scan CCD
- 128x wide dynamic range
- 540TVL high resolution
- True day / night
- 80m IR range
- 3D digital noise reduction
- IP66 rating

## Dimensions

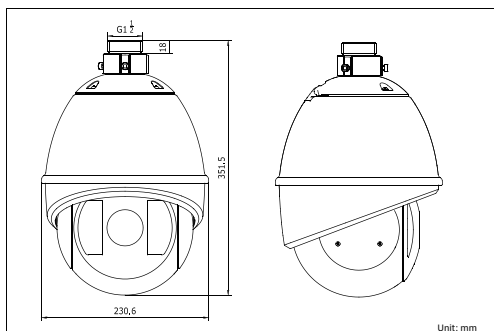

## Accessories



	DS-2AF1-713-B	DS-2AF1-715-B
<b>Camera</b>		
Image sensor	1/4" Sony EXVIEW HAD progressive scan CCD	
Effective pixel	PAL: 752 (H) × 582 (V), NTSC: 768 (H) × 494 (V)	
Horizontal resolution	Color: 540 TVL, B/W: 570 TVL	
Signal system	PAL / NTSC	
Min. illumination	Color: 0.7 lux@F1.4, B/W: 0.01 lux@F1.4 0 lux with IR	Color: 0.65 lux@F1.35, B/W: 0.005 lux@F1.35 0 lux with IR
White balance	Auto / manual / ATW / indoor / outdoor	
AGC	Auto / manual	
S/N ratio	≥ 50dB	
BLC	On / off	
WDR	128x (on / off / auto)	
Anti-shake	—	On / off
Shutter time	PAL: 1/3 ~ 1/10,000s, NTSC: 1/4 ~ 1/10,000s	
Day & night	IR cut filter	
Digital zoom	12x	
Privacy mask	24 privacy masks programmable; a maximum of 8 zones can be masked simultaneously on the same video screen	
Focus model	Auto / semi-automatic / manual	
<b>Lens</b>		
Focal length	4.1 ~ 73.8mm, 18x	3.5 ~ 98mm, 28x
Zoom speed	Approx. 2.0s (optical Wide-Tele)	Approx. 1.7s (optical Wide-Tele)
Angle of view	48 ~ 2.8° (Wide-Tele)	55.8 ~ 2.1° (Wide-Tele)
Min. working distance	290 ~ 800mm (Wide-Tele)	10 ~ 1,500mm (Wide-Tele)
Aperture range	F1.4 ~ F3.0	F1.35 ~ F3.7
<b>Pan and tilt</b>		
Pan range	360° endless	
Pan speed	Pan manual speed: 0.1° ~ 160°/s, pan preset speed: 240°/s	
Tilt range	-10° ~ 90° (auto flip)	
Tilt speed	Tilt manual speed: 0.1° ~ 120°/s, tilt preset speed: 200°/s	
Proportional zoom	Rotation speed can be adjusted automatically according to zoom multiples	
Number of preset	256	
Patrol	8 patrols, up to 32 presets per patrol	
Pattern	4 patterns, with the total recording time not less than 10 min	
Power loss recovery	Support	
Park action	Preset / patrol / pattern / pan scan / tilt scan / random scan / frame scan / panorama scan	
PTZ position display	On / off	
Freeze frame	Support	
Password protection	Support	
Zone scanning / display	Scanning within programmed zone, display zone title	
Camera title	Programmable title display	
Compass	Support, the north can be set	
Scheduled task	Preset / patrol / pattern / pan scan / tilt scan / random scan / frame scan / panorama scan	
RS-485 communication diagnosis	Including failure information, e.g., wrong address, baud rate errors, etc., displayed on the video screen in text	
Manchester code communication diagnosis	Including failure information, e.g., wrong address, baud rate errors s displayed on the video screen in special characters	
<b>Infrared</b>		
IR range	80m	
IR irradiation angle	Adjustable by zoom	
<b>Alarm</b>		
Alarm input	2 (additional wires required)	
Alarm output	2 relay outputs, alarm response actions configurable (additional wires required)	
Alarm action	Preset / patrol / pattern / pan scan / tilt scan / random scan / frame scan / panorama scan / relay output	
<b>Input / output</b>		
Monitor output	1.0V[p-p] / 75Ω, NTSC (or PAL) composite, BNC	
<b>Fiber interface (available for fiber dome only)</b>		
Data mode	1-channel analog video and 1-channel reverse RS-485 data	
Physical interface	FC (SC optional)	
Fiber wavelength	TX1310 / RX1550nm	
Fiber type	Single fiber / single mode	
Transmission distance	20km, 40km / 60km / 80km optional	
<b>General</b>		
Menu language	English, Chinese	
RS-485 protocols	HIKVISION, Pelco-P, Pelco-D, self-adaptive	
Power supply	24 VAC (12 VDC optional)	
Power consumption	40W max.	
Working temperature / humidity	-30°C ~ 65°C (-22°F ~ 149°F), 90% or less	
Protection level	IP66 standard, TVS 3,000V lightning protection, surge protection and voltage transient protection	
Mounting	Various mounting modes optional	
Dimensions	Φ 230.6 × 351.5mm (Φ 9.08" × 13.84")	
Weight (approx.)	5.5kg (12.13lbs)	

# DS-2AF1-513/515/517-B DS-2AF1-503/505/507-B

## WDR Analog High Speed Dome



### Key Features

- 1/4" Sony EXVIEW HAD progressive scan CCD
- 128x wide dynamic range
- 540 TVL high resolution
- True day / night
- 3D intelligent positioning function
- 3D digital noise reduction
- IP66 rating

### Dimensions

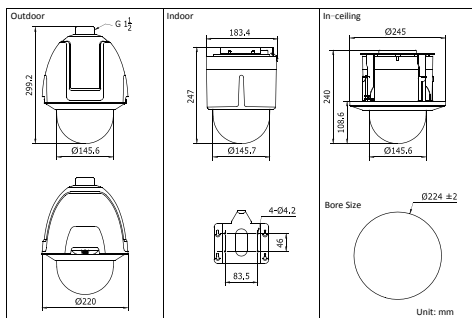

### Accessories



DS-1614ZJ  
(Long-arm Wall Mount Bracket)

	DS-2AF1-513-B (outdoor) DS-2AF1-503-B (indoor) DS-2AF1-533-B (in-ceiling)	DS-2AF1-515-B (outdoor) DS-2AF1-505-B (indoor) DS-2AF1-535-B (in-ceiling)	DS-2AF1-517-B (outdoor) DS-2AF1-507-B (indoor) DS-2AF1-537-B (in-ceiling)
<b>Camera</b>			
Image sensor	1/4" Sony EXVIEW HAD progressive scan CCD		
Effective pixel	PAL:752 (H) × 582 (V), NTSC:768 (H) × 494 (V)		
Horizontal resolution	Color: 540 TVL, B/W: 570 TVL		
Signal system	PAL / NTSC		
Min.illumination	Color: 0.7 lux@F1.4 B/W: 0.01 lux@F1.4	Color: 0.65 lux@F1.35 B/W: 0.005 lux@F1.35	Color: 1.4 lux@F1.6 B/W: 0.01 lux@F1.6
White balance	Auto / manual / ATW / indoor / outdoor		
AGC	Auto / manual		
S/N ratio	≥ 50dB		
BLC	On / off		
WDR	128x (on / off / auto)		
Anti-shake	—	On / off	On / off
Shutter time	PAL: 1/3 ~ 1/10,000s, NTSC: 1/4 ~ 1/10,000s		
Day & night	IR cut filter		
Digital zoom	12x		
Privacy mask	24 privacy masks programmable; a maximum of 8 zones can be masked simultaneously on the same video screen		
Focus model	Auto / semi-automatic / manual		
<b>Lens</b>			
Focal length	4.1 ~ 73.8mm, 18x	3.5 ~ 98mm,28x	3.4 ~ 122.4mm,36x
Zoom speed	Approx.2.0s (optical Wide-Tele)	Approx.1.7s (optical Wide-Tele)	Approx.2.7s (optical Wide-Tele)
Angle of view	48 ~ 2.8° (Wide-Tele)	55.8 ~ 2.1°(Wide-Tele)	57.8 ~ 1.7° (Wide-Tele)
Min. working distance	290 ~ 800mm (Wide-Tele)	10 ~ 1,500mm (Wide-Tele)	320 ~ 1,500mm (Wide-Tele)
Aperture range	F1.4 ~ F3.0	F1.35 ~ F3.7	F1.6 ~ F4.5
<b>Pan and tilt</b>			
Pan range	360° endless		
Pan speed	Pan manual speed: 0.1° ~ 400°/s, pan preset speed: 540°/s		
Tilt range	-5° ~ 185° (auto mirror)		
Tilt speed	Tilt manual speed: 0.1° ~ 240°/s, tilt preset speed: 400°/s		
Proportional zoom	Rotation speed can be adjusted automatically according to zoom multiples		
Number of preset	256		
Patrol	8 patrols, up to 32 presets per patrol		
Pattern	4 patterns, with the total recording time not less than 10 min		
Power loss recovery	Support		
Park action	Preset / patrol / pattern / pan scan / tilt scan / random scan / frame scan / panorama scan		
PTZ position display	On / off		
Freeze frame	Support		
Password protection	Support		
Zone scanning / display	Scanning within programmed zone, display zone title		
Camera title	Programmable title display		
Compass	Support , the north can be set		
Scheduled task	Preset / patrol / pattern / pan scan / tilt scan / random scan / frame scan / panorama scan		
RS-485 communication diagnosis	Including failure information, e.g., wrong address, baud rate errors, et., displayed on the video screen in text		
Manchester code communication diagnosis	Including failure information, e.g., wrong address, baud rate errors s displayed on the video screen in special characters		
<b>Alarm</b>			
Alarm input	2 (additional wires required)		
Alarm output	2 relay outputs, alarm response actions configurable (additional wires required)		
Alarm action	Preset / patrol / pattern / pan scan / tilt scan / random scan / frame scan / panorama scan / relay output		
<b>Input / output</b>			
Monitor output	1.0V[p-p] / 75Ω, NTSC (or PAL) composite, BNC		
<b>Fiber interface (available for fiber dome only)</b>			
Data mode	1-channel analog video and 1-channel reverse RS-485 data		
Physical interface	FC (SC optional)		
Fiber wavelength	TX1310 / RX1550nm		
Fiber type	Single fiber / single mode		
Transmission distance	20km, 40km / 60km / 80km optional		
<b>General</b>			
Menu language	English, Chinese		
RS-485 protocols	HIKVISION, Pelco-P, Pelco-D, self-adaptive		
Power supply	24 VAC (12 VDC optional)		
Power consumption	15W max. (30W max. with heater, outdoor dome)		
Working temperature / humidity	-30°C ~ 65°C (-22°F ~ 149°F) (outdoor) / -10°C ~ 50°C (14°F ~ 122°F) (indoor), 90% or less		
Protection level	IP66 standard (outdoor), TVS 3,000V lightning protection, surge protection and voltage transient protection		
Mounting	Various mounting modes optional		
Dimensions	Φ 220 × 299.2mm (Φ 8.66" × 11.78") (outdoor) Φ 183.4 × 247mm(Φ 7.22" × 9.72") (indoor) Φ 245 × 240mm (Φ 9.65" × 9.45") (in-ceiling)		
Weight (approx.)	5kg (11.02lbs)		

# DS-2AF1-514/516/518 DS-2AF1-504/506/508

## Analog High Speed Dome

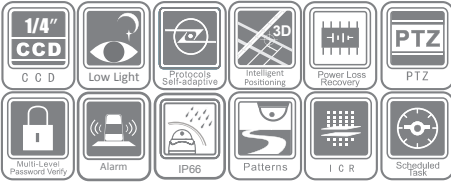

### Key Features

- 1/4" Sony Super HAD CCD
- Low illumination
- True day / night
- 3D intelligent positioning function
- Powerful PTZ control
- Programmable alarm triggering
- IP66 rating

### Dimensions

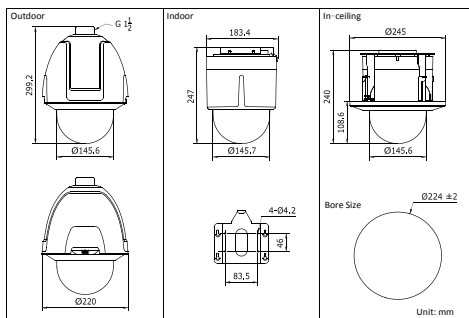

### Accessories



DS-1614ZJ  
(Long-arm Wall Mount Bracket)

	DS-2AF1-514 (outdoor) DS-2AF1-504 (indoor) DS-2AF1-534 (in-ceiling)	DS-2AF1-516 (outdoor) DS-2AF1-506 (indoor) DS-2AF1-536 (in-ceiling)	DS-2AF1-518 (outdoor) DS-2AF1-508 (indoor) DS-2AF1-538 (in-ceiling)
<b>Camera</b>			
Image sensor	1/4" Sony Super HAD CCD		
Effective pixel	PAL: 752 (H) × 582 (V), NTSC: 768 (H) × 494 (V)		
Horizontal resolution	Color: 540 TVL, B/W: 570 TVL		
Signal system	PAL / NTSC		
Min. illumination	Color: 0.2 lux@F1.6 B/W: 0.02 lux@F1.6	Color: 0.2 lux@F1.4 B/W: 0.02 lux@F1.4	Color: 0.2 lux@F1.6 B/W: 0.02 lux@F1.6
White balance	Auto / manual / ATW / indoor / outdoor		
AGC	Auto / manual		
S/N ratio	≥ 50dB		
BLC	On / off		
Shutter time	PAL: 1/50 ~ 1/10,000s NTSC: 1/60 ~ 1/10,000s	PAL: 1 ~ 1/10,000s NTSC: 1 ~ 1/10,000s	PAL: 1 ~ 1/10,000s NTSC: 1 ~ 1/10,000s
Day & night	IR cut filter		
Digital zoom	16x		
Focus model	Auto / semi-automatic / manual		
<b>Lens</b>			
Focal length	3.84 ~ 88.4mm, 23x	3.5 ~ 105mm, 30x	3.4 ~ 122.4mm, 36x
Zoom speed	Approx. 5.1s (optical Wide-Tele)	Approx. 5.4s (optical Wide-Tele)	Approx. 5.4s (optical Wide-Tele)
Angle of view	52.2 ~ 2.36° (Wide-Tele)	56.4 ~ 2.0° (Wide-Tele)	57.8 ~ 1.7° (Wide-Tele)
Min. working distance	10 ~ 1,200mm (Wide-Tele)	10 ~ 1,000mm (Wide-Tele)	10 ~ 1,000mm (Wide-Tele)
Aperture range	F1.6 ~ F4.5	F1.4 ~ F3.7	F1.6 ~ F4.5
<b>Pan and tilt</b>			
Pan range	360° endless		
Pan speed	Pan manual speed: 0.1° ~ 400°/s, pan preset speed: 540°/s		
Tilt range	-5° ~ 90° (auto flip)	-5° ~ 185° (auto mirror)	-5° ~ 185° (auto mirror)
Tilt speed	Tilt manual speed: 0.1° ~ 240°/s, tilt preset speed: 400°/s		
Proportional zoom	Rotation speed can be adjusted automatically according to zoom multiples		
Number of preset	256		
Patrol	8 patrols, up to 32 presets per patrol		
Pattern	4 patterns, with the total recording time not less than 10 min		
Power loss recovery	Support		
Park action	Preset / patrol / pattern / pan scan / tilt scan / random scan / frame scan / panorama scan		
PTZ position display	On / off		
Freeze frame	—	Support	Support
Password protection	Support		
Zone scanning / display	Scanning within programmed zone, display zone title		
Camera title	Programmable title display		
Compass	Support, the north can be set		
Scheduled task	Preset / patrol / pattern / pan scan / tilt scan / random scan / frame scan / panorama scan		
RS-485 communication diagnosis	Including failure information, e.g., wrong address, baud rate errors, et., displayed on the video screen in text		
Manchester code communication diagnosis	Including failure information, e.g., wrong address, baud rate errors s displayed on the video screen in special characters		
<b>Alarm</b>			
Alarm input	2 (additional wires required)		
Alarm output	2 relay outputs, alarm response actions configurable (additional wires required)		
Alarm action	Preset / patrol / pattern / pan scan / tilt scan / random scan / frame scan / panorama scan / relay output		
<b>Input / output</b>			
Monitor output	1.0V[p-p] / 75Ω, NTSC (or PAL) composite, BNC		
<b>Fiber interface (available for fiber dome only)</b>			
Data mode	1-channel analog video and 1-channel reverse RS-485 data		
Physical interface	FC (SC optional)		
Fiber wavelength	TX1310 / RX1550nm		
Fiber type	Single fiber / single mode		
Transmission distance	20km, 40km / 60km / 80km optional		
<b>General</b>			
Menu language	English, Chinese		
RS-485 protocols	HIKVISION, Pelco-P, Pelco-D, self-adaptive		
Power supply	24 VAC (12 VDC optional)		
Power consumption	15W max. (30W max. with heater, outdoor dome)		
Working temperature / humidity	-30°C ~ 65°C (-22°F ~ 149°F) (outdoor) / -10°C ~ 50°C (14°F ~ 122°F) (indoor), 90% or less		
Protection level	IP66 standard (outdoor), TVS 3,000V lightning protection, surge protection and voltage transient protection		
Mounting	Various mounting modes optional		
Dimensions	Φ 220 × 299.2mm (Φ 8.66" × 11.78") (outdoor) Φ 183.4 × 247mm (Φ 7.22" × 9.72") (indoor) Φ 245 × 240mm (Φ 9.65" × 9.45") (in-ceiling)		
Weight (approx.)	5kg (11.02lbs)		

# DS-2AF1-401X Indoor Analog High Speed Dome



## Key Features

- 1/4" Sony high performance CCD
- 500 TVL high resolution
- True day / night
- 3D intelligent positioning function
- Powerful PTZ control
- Programmable alarm triggering
- 10x optical zoom

## Dimensions

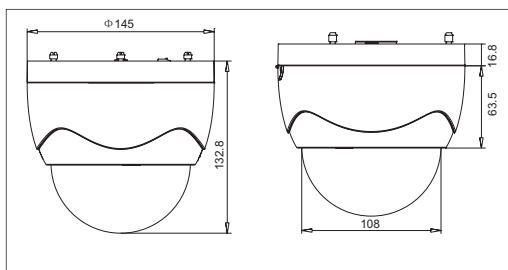

## Accessories



DS-2AF1-401X	
<b>Camera</b>	
Image sensor	1/4" Interline Transfer SONY CCD
Effective pixel	PAL: 752 (H) × 582 (V) NTSC: 768 (H) × 494 (V)
Horizontal resolution	Color: 500 TVL B/W: 570 TVL
Signal system	PAL / NTSC
Min.illumination	Color: 0.7 lux@F1.8 B/W: 0.02 lux@F1.8
White balance	Auto / manual / ATW / indoor / outdoor
AGC	Auto / manual
S/N ratio	≥ 50dB
BLC	On / off
Shutter time	PAL: 1/3 ~ 1/10,000s NTSC: 1/4 ~ 1/10,000s
Day & night	IR cut filter
Digital zoom	10x
Privacy mask	4 privacy masks programmable; a maximum of 4 zones can be masked simultaneously on the same video screen
Focus model	Auto / semi-automatic / manual
<b>Lens</b>	
Focal length	3.8 ~ 38mm, 10x
Zoom speed	Approx.1.7s (optical Wide-Tele)
Angle of view	51.2 ~ 5.58° (Wide-Tele)
Min. working distance	10 ~ 1,000mm (Wide-Tele)
Aperture range	F1.8 ~ F2.8
<b>Pan and tilt</b>	
Pan range	360° endless
Pan speed	Pan manual speed: 0.1° ~ 300°/s, Pan preset speed: 400°/s
Tilt range	-2° ~ 90° (auto flip)
Tilt speed	Tilt manual speed: 0.1° ~ 90°/s, Tilt preset speed: 200°/s
Proportional zoom	Rotation speed can be adjusted automatically according to zoom multiples
Number of preset	256
Patrol	8 patrols, up to 32 presets per patrol
Pattern	4 patterns, with the total recording time not less than 10 min
Power loss recovery	Support
Park action	Preset / patrol / pattern / pan scan / tilt scan / random scan / frame scan / panorama scan
PTZ position display	On / off
Freeze frame	Support
Password protection	Support
Zone scanning / display	Scanning within programmed zone, display zone title
Camera title	Programmable title display
Compass	Support, the north can be set
Scheduled task	Preset / patrol / pattern / pan scan / tilt scan / random scan / frame scan / panorama scan
RS-485 communication diagnosis	Including failure information, e.g., wrong address, baud rate errors, et., displayed on the video screen in text
Manchester code communication diagnosis	Including failure information, e.g., wrong address, baud rate errors s displayed on the video screen in special characters
<b>Alarm</b>	
Alarm input	2 (additional wires required)
Alarm output	1 relay outputs, alarm response actions configurable (additional wires required)
Alarm action	Preset / patrol / pattern / pan scan / tilt scan / random scan / frame scan / panorama scan / relay output
<b>Input / output</b>	
Monitor output	1.0 V [p-p] / 75 Ω, NTSC (or PAL) composite, BNC
<b>General</b>	
Menu language	English, Chinese
RS-485 protocols	HIKVISION, Pelco-P, Pelco-D, self-adaptive
Power supply	12 VDC (24 VAC optional)
Power consumption	12W max.
Working temperature / humidity	-10°C ~ 50°C (14°F ~ 122°F) (indoor), 90% or less
Mounting	Various mounting modes optional
Dimensions	Φ 145 × 132.8mm (Φ 5.71" × 5.23") (Indoor)
Weight (approx.)	2kg (4.41 lbs)

# CAMERA



# DS-2CD883F-E(W) 5 MP Network Camera



## Key features

- Up to 5 megapixel resolution
- Full HD 1080P real time video
- H.264 / MPEG4 / MJPEG video compression
- 1/2.5" progressive scan CMOS
- True day / night
- PoE

## Dimensions

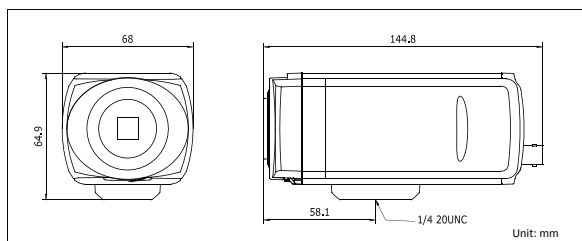

## Accessories



## Specifications

DS-2CD883F-E(W)	
<b>Camera</b>	
Image sensor	1/2.5" progressive scan CMOS
Min. illumination	Color: 0.6 lux@F1.2, AGC on B/W: 0.08 lux @F1.2, AGC on
Shutter time	1/25s ~ 1/100,000s
Lens mount	C/CS mount
Auto iris	DC drive
Day & night	IR cut filter with auto switch
<b>Compression standard</b>	
Video compression	H.264 / MPEG4 / MJPEG
Bit rate	32 kbps ~ 16 mbps
Audio compression	G.711
Dual stream	Yes
<b>Image</b>	
Max. image resolution	2560 × 1920
Frame rate	50 Hz: 6.25 fps (2560 × 1920) 12.5 fps (2048 × 1536) 25 fps (1920 × 1080) 25 fps (1600 × 1200) 25 fps (1280 × 720) 60 Hz: 7.5 fps (2560 × 1920) 15 fps (2048 × 1536) 30 fps (1920 × 1080) 30 fps (1600 × 1200) 30 fps (1280 × 720)
Image settings	Saturation, brightness, contrast adjustable through client software or web browser
<b>Network</b>	
Network storage	NAS (iSCSI optional)
Alarm trigger	Motion detection, network disconnect, IP address conflict, storage exception
Protocols	TCP/IP, HTTP, DHCP, DNS, DDNS, RTP/RTSP, PPPoE, SMTP, NTP (SNMP, HTTPS, SIP, FTP, SRTSP, 802.1x, IPv6 optional)
Security	Password protection, watermark
System compatibility	ONVIF, PSIA, CGI
<b>Interface</b>	
Audio input	1-ch microphone input, 3.5 mm mini-jack
Audio output	1-ch 3.5 mm audio interface (Line level, 600 Ω)
Communication interface	1 RJ45 10M / 100M ethernet port and 1 RS-485 interface
Alarm input	1
Alarm output	1
Video output	1 Vp-p composite output (75 Ω / BNC)
Local storage	Built-in SD/SDHC slot, up to 32 GB
Reset button	Yes
<b>General</b>	
Operating conditions	-10°C ~ 60°C (14°F ~ 140°F), humidity 90% or less (non-condensing)
Power supply	12 VDC ± 10%, PoE (802.3af)
Power consumption	5W max. (8W max. with IR cut filter on) -W: 7W max. (10W max. with IR cut filter on)
Dimensions	68 × 64.9 × 144.8 mm (2.68" × 2.56" × 5.70")
Weight	500g (1.10 lbs)

## Available models

DS-2CD883F-E, DS-2CD883F-EW

# DS-2CD854F-E(W) 3 MP Network Camera

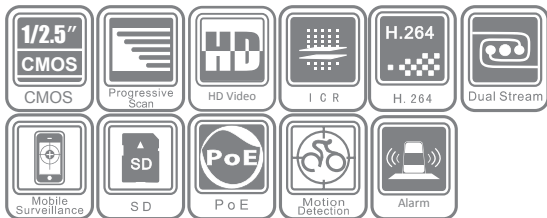

### Key features

- Up to 3 megapixel resolution
- Full HD 1080P real time video
- H.264 / MPEG4 / MJPEG video compression
- 1/2.5" progressive scan CMOS
- True day / night
- PoE

### Dimensions

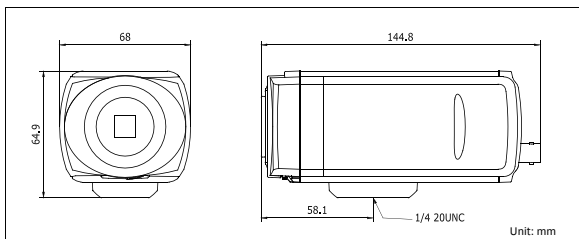

### Accessories



### Specifications

DS-2CD854F-E(W)	
<b>Camera</b>	
Image sensor	1/2.5" progressive scan CMOS
Min. illumination	Color: 0.6 lux@F1.2, AGC on B/W: 0.08 lux@F1.2, AGC on
Shutter time	1/25s ~ 1/100,000s
Lens mount	C/CS mount
Auto iris	DC drive
Day & night	IR cut filter with auto switch
<b>Compression standard</b>	
Video compression	H.264 / MPEG4 / MJPEG
Bit rate	32 Kbps ~ 16 Mbps
Audio compression	G.711
Dual stream	Yes
<b>Image</b>	
Max. image resolution	2048 × 1536
Frame rate	50 Hz: 12.5 fps (2048 × 1536) 25 fps (1920 × 1080) 25 fps (1600 × 1200) 60 Hz: 15 fps (2048 × 1536) 30 fps (1920 × 1080) 30 fps (1600 × 1200)
Image settings	Saturation, brightness, contrast adjustable through client software or web browser
<b>Network</b>	
Network storage	NAS (iSCSI optional)
Alarm trigger	Motion detection, network disconnect , IP address conflict, storage exception
Protocols	TCP/IP, HTTP, DHCP, DNS, DDNS, RTP/RTSP, PPPoE, SMTP, NTP (SNMP, HTTPS, SIP, FTP, SRTP, 802.1x, IPv6 optional)
Security	Password protection, watermark
System compatibility	ONVIF, PSIA, CGI
<b>Interface</b>	
Audio input	1-ch microphone input, 3.5 mm mini-jack
Audio output	1-ch 3.5 mm audio interface (line level, 600 Ω)
Communication interface	1 RJ45 10M / 100M ethernet port and 1 RS-485 interface
Alarm input	1
Alarm output	1
Video output	1 Vp-p composite output (75 Ω / BNC)
Local storage	Built-in SD/SDHC slot, up to 32 GB
Reset button	Yes
<b>General</b>	
Operating conditions	-10°C ~ 60°C (14°F ~ 140°F) Humidity 90% or less (non-condensing)
Power supply	12 VDC ± 10% , PoE (802.3af)
Power consumption	5.5W max. (8.5W max. with IR cut filter on) -W: 7W max. (10W max. with IR cut filter on)
Dimensions	68 × 64.9 × 144.8 mm (2.68" × 2.56" × 5.70")
Weight	500g (1.10 lbs)

### Available models

DS-2CD854F-E, DS-2CD854F-EW

# DS-2CD877BF 2 MP Network Camera



## Key features

- Up to 2 megapixel resolution
- Full HD 1080P real time video
- 2/3" progressive scan CCD
- True day / night
- Up to 32 GB SD/SDHC card local storage
- Support PTZ control

## Dimensions

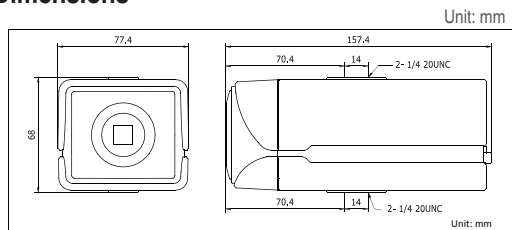

## Accessories



## Specifications

	DS-2CD877BF
<b>Camera</b>	
Image sensor	2/3" progressive scan CCD
Min. illumination	0.2 lux@F1.2, AGC on
Shutter time	1/25s ~ 1/30,000s
Lens mount	C/CS mount
Auto iris	DC drive
Day & night	Electronic
<b>Compression standard</b>	
Video compression	H.264 / MJPEG
Bit rate	32 Kbps ~ 16 Mbps
Audio compression	G.711
Dual stream	Yes
<b>Image</b>	
Max. image resolution	1920 × 1080
Frame rate	50 HZ: 25 fps (1920 × 1080) 60 HZ: 30 fps (1920 × 1080)
Image settings	Saturation, brightness, contrast adjustable through client software or web browser
<b>Network</b>	
Network storage	NAS (iSCSI optional)
Alarm trigger	Motion detection, video tampering, network disconnect, IP address conflict, storage exception
Protocols	TCP/IP, HTTP, DHCP, DNS, DDNS, RTP/RTSP, PPPoE, SMTP, NTP (SNMP, HTTPS, FTP, SIP, SRTP, 802.1x, IPv6 optional)
Security	Password protection, watermark
<b>Interface</b>	
Audio input	1-ch 3.5 mm audio interface (2.0 ~ 2.4 Vp-p, 1 kΩ)
Audio output	1-ch 3.5 mm audio interface (line level, 600 Ω)
Communication interface	1 RJ45 10M / 100M ethernet interface, 1 RS-485 interface, 1 RS-232 interface
Alarm input	4
Alarm output	3
Video output	1 Vp-p composite output (75 Ω / BNC)
Local storage	Built-in SD/SDHC slot, up to 32 GB
Reset button	Yes
<b>General</b>	
Operating conditions	-10°C ~ 60°C (14°F ~ 140°F) Humidity 90% or less (non-condensing)
Power supply	12 VDC ± 10%
Power consumption	15W max.
Dimensions	77.4 × 68 × 157.4 mm (3.05" × 2.68" × 6.20")
Weight	1000g (2.20 lbs)

## Available models

DS-2CD877BF



# DS-2CD853F-E(W) 2 MP Network Camera

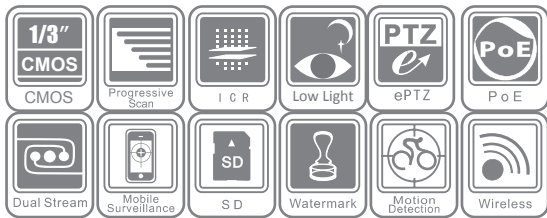

### Key features

- Up to 2 megapixel resolution
- H.264 / MPEG4 / MJPEG video compression
- 1/3" progressive scan CMOS
- True day / night
- ePTZ control
- PoE

### Dimensions

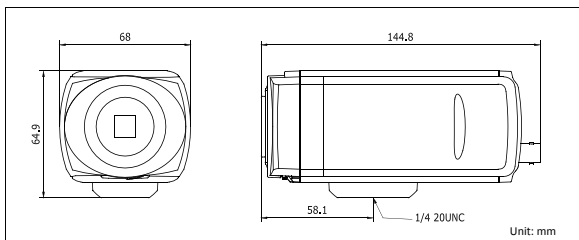

### Accessories



### Specifications

DS-2CD853F-E(W)	
<b>Camera</b>	
Image sensor	1/3" progressive scan CMOS
Min. illumination	Color: 0.5 lux@F1.2, AGC on, 0.1 lux@F1.2, AGC on, sens-up × 5 B/W: 0.05 lux@F1.2, AGC on, 0.01 lux@F1.2, AGC on, sens-up × 5
Shutter time	1/25s - 1/100,000s
Lens mount	C/CS mount
Auto iris	DC drive
Day & night	IR cut filter with auto switch
<b>Compression standard</b>	
Video compression	H.264 / MPEG4 / MJPEG
Bit rate	32 Kbps ~ 16 Mbps
Audio compression	G.711
Dual stream	Yes
<b>Image</b>	
Max. image resolution	1600 x 1200
Frame rate	50 Hz: 12.5 fps (1600 × 1200) 12.5 fps (1600 × 912) 25 fps (1280 × 960) 25 fps (1280 × 720) 60 Hz: 15 fps (1600 × 1200) 15 fps (1600 × 912) 25 fps (1280 × 960) 30 fps (1280 × 720)
Image settings	Saturation, brightness, contrast adjustable through client software or web browser
<b>Network</b>	
Network storage	NAS (iSCSI optional)
Alarm trigger	Motion detection, network disconnect , IP address conflict, storage exception
Protocols	CP/IP, HTTP, DHCP, DNS, DDNS, RTP/RTSP, PPPoE, SMTP, NTP (SNMP, HTTPS, SIP, FTP, SRTP, 802.1x, IPv6 optional)
Security	Password protection, watermark
System compatibility	ONVIF, PSIA, CGI
<b>Interface</b>	
Audio input	1-ch microphone input, 3.5 mm mini-jack
Audio output	1-ch 3.5 mm audio interface (line level, 600 Ω)
Communication interface	1 RJ45 10M / 100M ethernet port and 1 RS-485 interface
Alarm input	1
Alarm output	1
Video output	1 Vp-p composite output (75 Ω / BNC)
Local storage	Built-in SD/SDHC slot, up to 32 GB
Reset sutton	Yes
<b>General</b>	
Operating conditions	-10°C ~ 60°C (14°F ~ 140°F) Humidity 90% or less (non-condensing)
Power supply	12 VDC ± 10%, PoE (802.3af)
Power consumption	4.5W max. (7.5W max. with IR cut filter on) -W: 6W max. (9W max. with IR cut filter on)
Dimensions	68 × 64.9 × 144.8 mm (2.68" × 2.56" × 5.70")
Weight	500g (1.10 lbs)

### Available models

DS-2CD853F-E, DS-2CD853F-EW

# DS-2CD864FWD-E 1.3 MP WDR Network Camera



## Key features

- H.264 / MPEG4 / MJPEG video compression
- Up to 30 fps at 1280 x 960 resolution
- 120 dB wide dynamic range
- True day / night
- 3D digital noise reduction
- Power over ethernet

## Dimensions

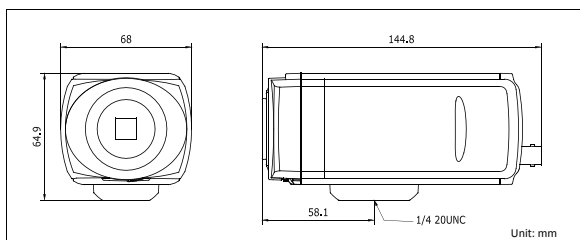

## Accessories



## Specifications

DS-2CD864FWD-E	
<b>Camera</b>	
Image sensor	1/3" progressive scan CMOS
Min. illumination	Color: 0.6 lux@F1.2, AGC on B/W: 0.08 lux@F1.2, AGC on
Shutter time	1/25s ~ 1/100,000s
Lens mount	C/CS mount
Auto iris	DC drive
Day & night	IR cut filter with auto switch
Wide dynamic range	120 dB
<b>Compression standard</b>	
Video compression	H.264 / MPEG4 / MJPEG
Bit rate	32 Kbps ~ 16 Mbps
Audio compression	G.711
Dual stream	Yes
<b>Image</b>	
Max. image resolution	1280 x 960
Frame rate	50 Hz: 25 fps (1280 x 960) 25 fps (1280 x 720) 60 Hz: 30 fps (1280 x 960) 30 fps (1280 x 720)
Image settings	Saturation, brightness, contrast adjustable through client software or web browser
<b>Network</b>	
Network storage	NAS (iSCSI optional)
Alarm trigger	Motion detection, network disconnect, IP address conflict, storage exception
Protocols	TCP/IP, HTTP, DHCP, DNS, DDNS, RTP/RTSP, PPPoE, SMTP, NTP (SNMP, HTTPS, FTP, SIP, 802.1x, IPv6 optional)
Security	Password protection, watermark
System compatibility	ONVIF, PSIA, CGI
<b>Interface</b>	
Audio input	1-ch microphone input, 3.5 mm mini-jack
Audio output	1-ch 3.5 mm audio interface (line level, 600 Ω)
Communication interface	1 RJ45 10M / 100M ethernet interface, 1 RS-485 interface
Alarm input	1
Alarm output	1
Video output	1 Vp-p composite output (75 Ω / BNC)
Local storage	Built-in SD/SDHC slot, up to 32 GB
Reset button	Yes
<b>General</b>	
Operating conditions	-10°C ~ 60°C (14°F ~ 140°F) Humidity 90% or less (non-condensing)
Power supply	12 VDC ± 10%, PoE (802.3af)
Power consumption	5.5W max. (8.5W max. with IR cut filter on)
Dimensions	68 × 64.9 × 144.8 mm (2.7" × 2.2" × 5.7")
Weight	500g (1.1 lbs)

## Available models

DS-2CD864FWD-E

# DS-2CD863P(N)F-E(W) 1.3 MP Network Camera

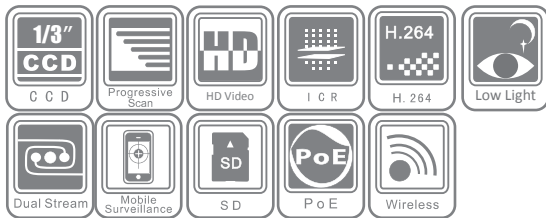

### Key features

- Up to 1.3 megapixel resolution
- H.264 / MPEG4 / MJPEG video compression
- 1/3" Sony progressive scan CCD
- HD 720P real time video
- True day / night
- PoE

### Dimensions

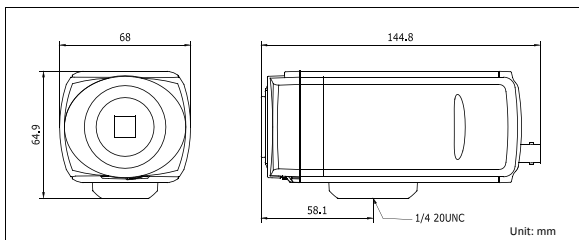

### Accessories



### Specifications

DS-2CD863PF-E(W) / DS-2CD863NF-E(W)	
<b>Camera</b>	
Image sensor	1/3" Sony progressive scan CCD
Signal system	PAL / NTSC
Min. illumination	Color: 0.1 lux@F1.2, AGC on B/W: 0.01 lux@F1.2, AGC on
Shutter time	1/25 (1/30)s ~ 1/100,000s
Lens mount	C/CS mount
Auto iris	DC drive
Day & night	IR cut filter with auto switch
<b>Compression standard</b>	
Video compression	H.264 / MPEG4 / MJPEG
Bit rate	32 Kbps ~ 16 Mbps
Audio compression	G.711
Dual stream	Yes
<b>Image</b>	
Max. image resolution	1280 x 960
Frame rate	50 Hz: 12.5 fps (1280 x 960) 25 fps (1280 x 720) 60 Hz: 15 fps (1280 x 960) 30 fps (1280 x 720)
Image settings	Saturation, brightness, contrast adjustable through client software or web browser
<b>Network</b>	
Network storage	NAS (iSCSI optional)
Alarm trigger	Motion detection, network disconnect, IP address conflict, storage exception
Protocols	TCP/IP, HTTP, DHCP, DNS, DDNS, RTP/RTSP, PPPoE, SMTP, NTP (SNMP, HTTPS, SIP, FTP, SRTSP, 802.1x, IPv6 optional)
Security	Password protection, watermark
System compatibility	ONVIF, PSIA, CGI
<b>Interface</b>	
Audio input	1-ch microphone input, 3.5 mm mini-jack
Audio output	1-ch 3.5 mm audio interface (line level, 600 Ω)
Communication interface	1 RJ45 10M / 100M ethernet port and 1 RS-485 interface
Alarm input	1
Alarm output	1
Video output	1 Vp-p composite output (75 Ω / BNC)
Local storage	Built-in SD/SDHC slot, up to 32 GB
Reset button	Yes
<b>General</b>	
Operating conditions	-10°C ~ 60°C (14°F ~ 140°F) Humidity 90% or less (non-condensing)
Power supply	12 VDC ± 10%, PoE (802.3af)
Power consumption	7.5W max. (12.5W max. with IR cut filter on) -W: 9W max. (14W max. with IR cut filter on)
Dimensions	68 x 64.9 x 144.8 mm (2.68" x 2.56" x 5.70")
Weight	500g (1.10 lbs)

### Available models

DS-2CD863PF-E, DS-2CD863NF-E, DS-2CD863PF-EW, DS-2CD863NF-EW

# DS-2CD893P(N)FWD-E(W)

# WDR Network Camera



## Key features

- Real time video at 4CIF
- H.264 / MPEG4 / MJPEG video compression
- 1/3" Sony vertical double density interline CCD
- 160x wide dynamic range
- True day / night
- PoE

## Dimensions

Unit: mm

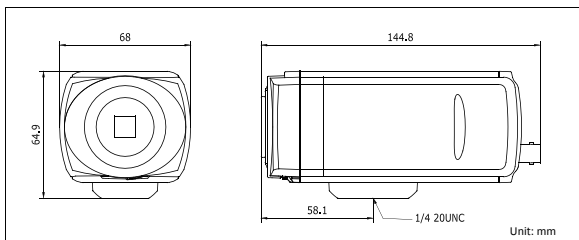

## Accessories



## Specifications

	DS-2CD893PFWD-E(W) / DS-2CD893NFWD-E(W)
<b>Camera</b>	
Image sensor	1/3" Sony vertical double density interline CCD
Signal system	PAL / NTSC
Min. illumination	Color: 0.1 lux@F1.2, AGC on B/W: 0.01 lux@F1.2, AGC on
Shutter time	1/25 (1/30)s ~ 1/100,000s
Lens mount	C/CS mount
Auto iris	DC drive
Day & night	IR cut filter with auto switch
Wide dynamic range	160x
<b>Compression standard</b>	
Video compression	H.264 / MPEG4 / MJPEG
Bit rate	32 Kbps ~ 8 Mbps
Audio compression	G.711
Dual stream	Yes
<b>Image</b>	
Max. image resolution	PAL: 704 × 576 NTSC: 704 × 480
Frame rate	50 HZ: 25 fps (704 × 576) 60 HZ: 30 fps (704 × 480)
Image settings	Saturation, brightness, contrast adjustable through client software or web browser
<b>Network</b>	
Network storage	NAS (iSCSI optional)
Alarm trigger	Motion detection, network disconnect, IP address conflict, storage exception
Protocols	TCP/IP, HTTP, DHCP, DNS, DDNS, RTP/RTSP, PPPoE, SMTP, NTP (SNMP, HTTPS, SIP, FTP, SRTP, 802.1x, IPv6 optional)
Security	Password protection, watermark
System compatibility	ONVIF, PSIA, CGI
<b>Interface</b>	
Audio input	1-ch microphone input, 3.5 mm mini-jack
Audio output	1-ch 3.5 mm audio interface (line level, 600 Ω)
Communication interface	1 RJ45 10M / 100M ethernet port and 1 RS-485 interface
Alarm input	1
Alarm output	1
Video output	1 Vp-p composite output (75 Ω / BNC)
Local storage	Built-in SD/SDHC slot, up to 32 GB
Reset button	Yes
<b>General</b>	
Operating conditions	-10°C ~ 60°C (14°F ~ 140°F) Humidity 90% or less (non-condensing)
Power supply	12 VDC ± 10%, PoE (802.3af)
Power consumption	5.5W max. (8.5W max. with IR cut filter on) -W: 7W max. (10W max. with IR cut filter on)
Dimensions	68 × 64.9 × 144.8 mm (2.67" × 2.56" × 5.70")
Weight	500g (1.10 lbs)

## Available models

DS-2CD893PFWD-E, DS-2CD893NFWD-E, DS-2CD893PFWD-EW, DS-2CD893NFWD-EW

# DS-2CD893P(N)F-E(W) 4CIF Network Camera

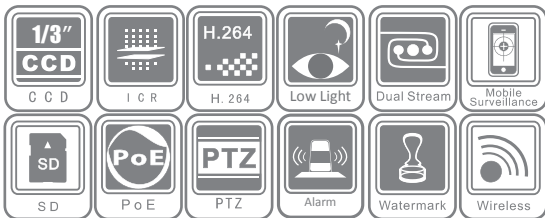

## Key features

- Real time video at 4CIF
- H.264 / MPEG4 / MJPEG video compression
- High performance 1/3" Sony CCD
- Super low illumination
- True day / night
- PoE

## Dimensions

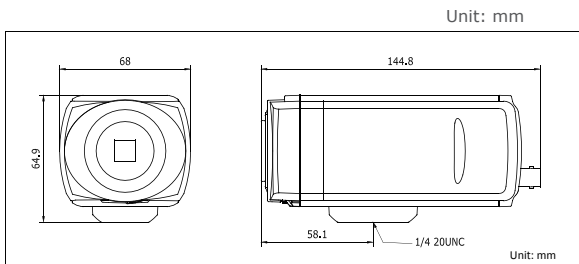

## Accessories



## Specifications

DS-2CD893PF-E(W) / DS-2CD893NF-E(W)	
<b>Camera</b>	
Image sensor	1/3" Sony CCD
Signal system	PAL / NTSC
Min. illumination	Color: 0.02 lux@F1.2, AGC on B/W: 0.002 lux@F1.2, AGC on
Shutter time	1/25 (1/30)s ~ 1/100,000s
Lens mount	C/CS mount
Auto iris	DC drive
Day & night	IR cut filter with auto switch
<b>Compression standard</b>	
Video compression	H.264 / MPEG4 / MJPEG
Bit rate	32 Kbps ~ 16 Mbps
Audio compression	G.711
Dual stream	Yes
<b>Image</b>	
Max. image resolution	PAL: 704 × 576 NTSC: 704 × 480
Frame rate	50 HZ: 25 fps (704 × 576) 60 HZ: 30 fps (704 × 480)
Image settings	Saturation, brightness, contrast adjustable through client software or web browser
<b>Network</b>	
Network storage	NAS (iSCSI optional)
Alarm trigger	Motion detection, network disconnect , IP address conflict, storage exception
Protocols	TCP/IP, HTTP, DHCP, DNS, DDNS, RTP/RTSP, PPPoE, SMTP, NTP (SNMP, HTTPS, SIP, FTP, SRTP, 802.1x, IPv6 optional)
Security	Password protection, watermark
System compatibility	ONVIF, PSIA, CGI
<b>Interface</b>	
Audio input	1-ch microphone input, 3.5 mm mini-jack
Audio output	1-ch 3.5 mm audio interface (line level, 600 Ω)
Communication interface	1 RJ45 10M / 100M ethernet port and 1 RS-485 interface
Alarm input	1
Alarm output	1
Video output	1 Vp-p composite output (75 Ω / BNC)
Local storage	Built-in SD/SDHC slot, up to 32 GB
Reset button	Yes
<b>General</b>	
Operating conditions	-10°C ~ 60°C (14°F ~ 140°F) Humidity 90% or less (non-condensing)
Power supply	12 VDC ± 10%, PoE (802.3af)
Power consumption	5.5W max. (8.5W max. with IR cut filter on) -W: 7W max. (10W max. with IR cut filter on)
Dimensions	68 × 64.9 × 144.8 mm (2.67" × 2.56" × 5.70")
Weight	500g (1.10 lbs)

## Available models

DS-2CD893PF-E, DS-2CD893NF-E, DS-2CD893PF-EW, DS-2CD893NF-EW

# DS-2CD802/812P(N)F-E(W)

# Network Box Camera

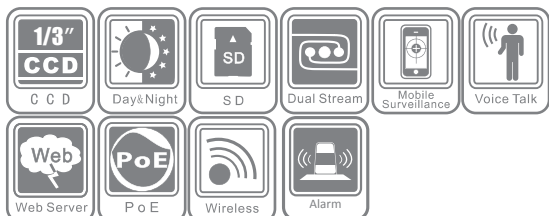

## Key features

- High performance Sony CCD
- H.264 / MPEG4 dual stream video compression
- Support 32 GB SD/SDHC card local storage
- Day / night auto switch

## Dimensions

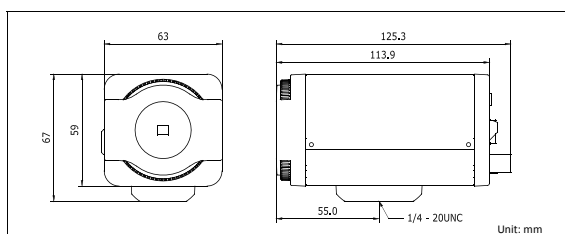

## Accessories



## Specifications

	DS-2CD802P(N)F-E(W)	DS-2CD812P(N)F-E(W)
<b>Camera</b>		
Image sensor	1/3" Sony CCD	
Signal system	PAL / NTSC	
Min. illumination	0.1 lux@F1.2, ACG on	
Shutter time	1/50 (1/60)s ~ 1/100,000s	
Lens mount	C/CS mount	
Auto iris	DC/Video	
Day & night	Electronic	
Horizontal resolution	420 TVL	480 TVL
<b>Compression standard</b>		
Video compression	H.264 (MPEG-4 optional)	
Bit rate	32 Kbps ~ 8 Mbps	
Audio compression	OggVorbis	
Dual stream	Yes	
<b>Image</b>		
Max. image resolution	PAL: 704 × 576 NTSC: 704 × 480	
Frame rate	50 HZ: 25 fps (704 × 576) 60 HZ: 30 fps (704 × 480)	
Image settings	Saturation, brightness, contrast adjustable through client software or web browser	
<b>Network</b>		
Alarm Trigger	Motion detection	
Protocols	TCP/IP, HTTP, DHCP, DNS, RTP/RTSP, PPPoE (FTP, SMTP, NTP, SNMP optional)	
Security	Password protection	
Security	Password protection, Watermark	
<b>Interface</b>		
Audio input	1-ch, 3.5 mm audio interface (2.0 - 2.4 Vp-p, 1 kΩ)	
Audio output	1-ch, 3.5 mm audio interface (line level, 600 Ω)	
Communication interface	1 RJ45 10M / 100M ethernet port and 1 RS-485 interface	
Alarm input	1	
Alarm output	1	
Video output	1 Vp-p composite output (75 Ω / BNC)	
Local storage	Built-in SD/SDHC slot, up to 32 GB	
Reset button	Yes	
<b>General</b>		
Operating conditions	-10°C ~ 60°C (14°F ~ 140°F) Humidity 90% or less (non-condensing)	
Power supply	12 VDC ± 10%, PoE (802.3af)	
Power consumption	4W max. -W: 5.5W max.	
Dimensions	63 x 67 x 125 mm (2.48" x 2.64" x 4.92")	
Weight	650g (1.43 lbs)	

## Available models

DS-2CD802PF-E, DS-2CD802PF-W, DS-2CD812PF, DS-2CD812PF-E, DS-2CD812PF-W  
DS-2CD802NF-E, DS-2CD802NF-W, DS-2CD812NF, DS-2CD812NF-E, DS-2CD812NF-W

# DS-2CD833F-E(W) Low Light Network Camera



## Key features

- Real time video at VGA (640 × 480)
- H.264 / MPEG4 / MJPEG video compression
- 1/4" progressive scan CMOS
- Super low illumination
- True day / night
- PoE

## Dimensions

Unit: mm

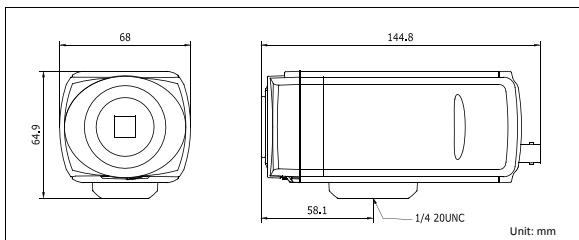

## Accessories



## Specifications

DS-2CD833F-E(W)	
<b>Camera</b>	
Image sensor	1/4" progressive scan CMOS
Min. illumination	Color: 0.01 lux@F1.2, AGC on B/W: 0.001 lux@F1.2, AGC on
Shutter time	1/25s ~ 1/100,000s
Lens mount	C/CS mount
Auto iris	DC drive
Day & night	IR cut filter with auto switch
<b>Compression standard</b>	
Video compression	H.264 / MPEG4 / MJPEG
Bit rate	32 Kbps ~ 8 Mbps
Audio compression	G.711
Dual stream	Yes
<b>Image</b>	
Max. Image resolution	640 × 480
Frame rate	50 Hz: 25 fps (640 × 480) 60 Hz: 30 fps (640 × 480)
Image settings	Saturation, brightness, contrast adjustable through client software or web browser
<b>Network</b>	
Network storage	NAS (iSCSI optional)
Alarm trigger	Motion detection, network disconnect, IP address conflict, storage exception
Protocols	TCP/IP, HTTP, DHCP, DNS, DDNS, RTP/RTSP, PPPoE, SMTP, NTP (SNMP, HTTPS, SIP, FTP, SRTSP, 802.1x, IPv6 optional)
Security	Password protection, watermark
System compatibility	ONVIF, PSIA, CGI
<b>Interface</b>	
Audio input	1-ch microphone input, 3.5 mm mini-jack
Audio output	1-ch 3.5 mm audio interface (line level, 600 Ω)
Communication interface	1 RJ45 10M / 100M ethernet port and 1 RS-485 interface
Alarm input	1
Alarm output	1
Video output	1 Vp-p composite output (75 Ω / BNC)
Local storage	Built-in SD/SDHC slot, up to 32 GB
Reset button	Yes
<b>General</b>	
Operating conditions	-10°C ~ 60°C (14°F ~ 140°F) Humidity 90% or less (non-condensing)
Power supply	12 VDC ± 10%, PoE (802.3af)
Power consumption	4.5W max. (7.5W max. with IR cut filter on) -W: 6W max. (9W max. with IR cut filter on)
Dimensions	68 × 64.9 × 144.8 mm (2.67" × 2.56" × 5.70")
Weight	500g (1.10 lbs)

## Available models

DS-2CD833F-E, DS-2CD833F-EW

# DS-2CD802/812/892P(N)-IR1/IR3/IR5 IR Bullet Network Camera



## Key features

- High performance 1/3" Sony CCD
- H.264 video compression
- Dual stream real time video
- Support PTZ control
- Day / night auto switch
- IP66 rating

## Dimensions

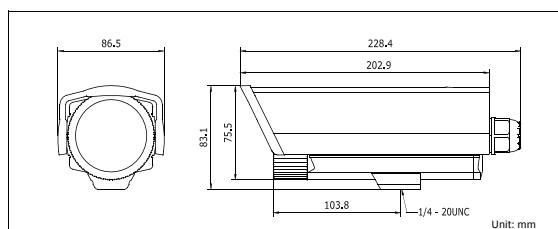

## Accessories

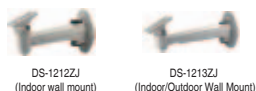

## Specifications

	DS-2CD802P(N)-IR1/IR3/IR5	DS-2CD812P(N)-IR1/IR3/IR5	DS-2CD892P(N)-IR1/IR3/IR5
<b>Camera</b>			
Image sensor	1/3" Sony CCD		
Signal system	PAL / NTSC		
Min. illumination	0.1 lux@F1.2, AGC on, 0 lux with IR 0.2 lux@F1.8, AGC on, 0 lux with IR		
Shutter time	1/50 (1/60)s ~ 1/100,000s		
Lens	"-IR1" series: 6mm @F1.8 (2.8mm, 3.6mm optional), angle of view: 47° (6mm) "-IR3" series: 12mm @F1.8 (3.6mm, 6mm, 8mm, 16mm optional), angle of view: 22.72° (6mm) "-IR5" series: 16mm @F1.8 (3.6mm, 6mm, 8mm, 12mm optional), angle of view: 16.4° (6mm)		
Lens mount	M12		
Day & night	Electronic		
Horizontal resolution	420 TVL	480 TVL	540 TVL
<b>Compression standard</b>			
Video compression	H.264 (MPEG-4 optional)		
Bit rate	32 Kbps ~ 8 Mbps		
Audio compression	OggVorbis		
Dual stream	Yes		
<b>Image</b>			
Max. image resolution	PAL: 704 × 576 NTSC: 704 × 480		
Frame rate	50 Hz: 25 fps (704 × 576) 60 Hz: 30 fps (704 × 480)		
Image settings	Saturation, brightness, contrast adjustable through client software or web browser		
<b>Network</b>			
Alarm trigger	Motion detection		
Protocols	TCP/IP, HTTP, DHCP, DNS, RTP/RTSP, PPPoE (FTP, SMTP, NTP, SNMP optional)		
Security	Password protection		
<b>Interface</b>			
Audio input	1-ch, 3.5mm audio interface (2.0 - 2.4 Vp-p, 1 kΩ)		
Audio output	1-ch, 3.5mm audio interface (line level, 600 Ω)		
Communication interface	1 RJ45 10M / 100M ethernet port and 1 RS-485 interface		
Alarm input	1		
Alarm output	1		
Video output	1 Vp-p composite output (75 Ω/BNC)		
<b>General</b>			
Operating conditions	-10°C ~ 60°C (14°F ~ 140°F) Humidity 90% or less (non-condensing)		
Power supply	12 VDC ± 10%		
Power consumption	"-IR1" series: 5.5W max. "-IR3" series: 7W max. "-IR5" series: 9W max.		
Weather proof rating	IP66		
IR range	"-IR1" series: 10 - 20m "-IR3" series: 30 - 40m "-IR5" series: 50 - 60m		
Dimensions	86.5 × 83.1 × 228.4mm (3.41" × 3.27" × 8.99")		
Weight	1400g (3.09 lbs)		

## Available models

DS-2CD802P-IR1/IR3/IR5, DS-2CD802N-IR1/IR3/IR5, DS-2CD812P-IR1/IR3/IR5  
DS-2CD812N-IR1/IR3/IR5, DS-2CD892P-IR1/IR3/IR5, DS-2CD892N-IR1/IR3/IR5



# DS-2CD8253F-EI(S) IR Bullet Network Camera

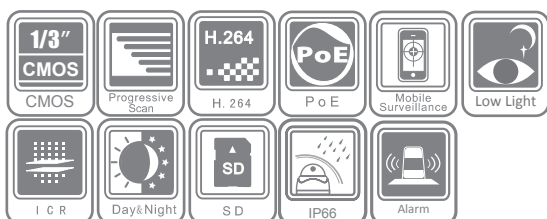

## Key features

- 1/3" progressive scan CMOS
- H.264 / MPEG4 / MJPEG video compression
- Up to 2 megapixel (1600 × 1200) resolution
- ePTZ control
- True day / night
- IP66 rating
- POE

## Dimensions

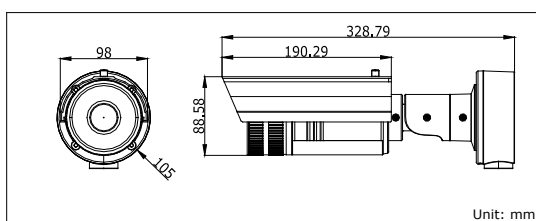

## Specifications

DS-2CD8253F-EI(S)	
<b>Camera</b>	
Image sensor	1/3" progressive scan CMOS
Min. illumination	0.5 lux@F1.2, AGC on 0.1 lux@F1.2, AGC on, sens-up × 5 0 lux with IR
Shutter time	1/25s ~ 1/100,000 s
Lens	2.7 ~ 9mm @F1.2 Angle of view: 101° ~ 30.4°
Lens mount	Φ14
Auto iris	DC drive
Day & night	IR cut filter with auto switch
<b>Compression standard</b>	
Video compression	H.264 / MPEG4 / MJPEG
Bit rate	32 Kbps ~ 16 Mbps
Dual stream	Yes
<b>Image</b>	
Max. image resolution	1600 × 1200
Frame rate	50 Hz: 12.5 fps (1600 × 1200) 12.5 fps (1600 × 912) 25 fps (1280 × 960) 25 fps (1280 × 720) 60 Hz: 15 fps (1600 × 1200) 15 fps (1600 × 912) 25 fps (1280 × 960) 30 fps (1280 × 720)
Image settings	Saturation, brightness, contrast adjustable through client software or web browser
<b>Network</b>	
Network storage	NAS (iSCSI optional)
Alarm trigger	Motion detection, network disconnect , IP address conflict, storage exception
Protocols	TCP/IP, HTTP, DHCP, DNS, DDNS, RTP/RTSP, PPPoE, SMTP, NTP (SNMP, HTTPS, FTP, SIP, SRTP, 802.1x, IPv6 optional)
Security	Password protection, watermark
<b>Interface</b>	
Communication interface	1 RJ45 10M / 100M ethernet interface
Local storage	Built-in SD/SDHC slot, up to 32 GB
Reset button	Yes
<b>General</b>	
Operating conditions	-10°C ~ 60°C (14°F ~ 140°F) Humidity 90% or less (non-condensing)
Power supply	12 VDC ± 10%, PoE (802.3af)
Power consumption	8.5W max.
Weather-proof rating	IP66
IR range	Approx. 20 ~ 30m
Dimensions	98 × 88.58 × 328.79 mm (3.86" × 3.49" × 12.94")
Weight	1700g (3.75 lbs)

## Available models

DS-2CD8253F-EI, DS-2CD8253F-EIS

\*-S\*: is equipped with audio, alarm and RS-485 interface.

# DS-2CD8254F-EI(S) IR Bullet Network Camera

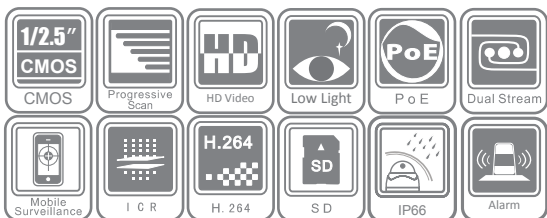

## Key features

- 1/2.5" progressive scan CMOS
- H.264 / MPEG4 / MJPEG video compression
- Up to 3 megapixel (2048 x 1536) resolution
- Full HD 1080P real time video
- True day / night
- IP66 rating

## Dimensions

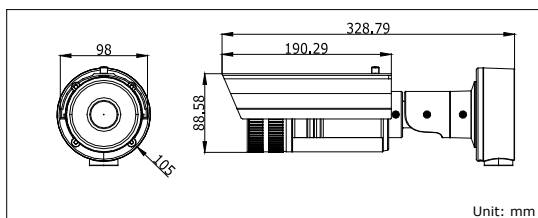

## Specifications

DS-2CD8254F-EI(S)	
<b>Camera</b>	
Image sensor	1/2.5" progressive scan CMOS
Min. illumination	0.6 lux@F1.2, AGC on, 0 lux with IR 0.7 lux@F1.6, AGC on, 0 lux with IR
Shutter time	1/25s ~ 1/100,000s
Lens	2.7 ~ 9 mm @F1.6 Angle of view: 94.7° ~ 28.6°
Lens mount	Φ 14
Auto iris	DC drive
Day & night	IR cut filter with auto switch
<b>Compression Standard</b>	
Video compression	H.264 / MPEG4 / MJPEG
Bit rate	32 Kbps ~ 16 Mbps
Dual stream	Yes
<b>Image</b>	
Max. image resolution	2048 x 1536
Frame rate	50 Hz: 12.5 fps (2048 x 1536) 25 fps (1920 x 1080) 25 fps (1600 x 1200) 60 Hz: 15 fps (2048 x 1536) 30 fps (1920 x 1080) 30 fps (1600 x 1200)
Image settings	Saturation, brightness, contrast adjustable through client software or web browser
<b>Network</b>	
Network storage	NAS (iSCSI optional)
Alarm trigger	Motion detection, network disconnect, IP address conflict, storage exception
Protocols	TCP/IP, HTTP, DHCP, DNS, DDNS, RTP/RTSP, PPPoE, SMTP, NTP (SNMP, HTTPS, FTP, SIP, SRTP, 802.1x, IPv6 optional)
Security	Password protection, watermark
<b>Interface</b>	
Communication interface	1 RJ45 10M / 100M ethernet interface
Local storage	Built-in SD/SDHC slot, up to 32 GB
<b>General</b>	
Operating conditions	-10°C ~ 60°C (14°F ~ 140°F) Humidity 90% or less (non-condensing)
Power supply	12 VDC ± 10%, PoE (802.3af)
Power consumption	9.5W max.
Weather proof rating	IP66
IR range	Approx. 20 ~ 30m
Dimensions	98 × 88.58 × 328.79 mm (3.86" × 3.49" × 12.94")
Weight	1700g (3.75 lbs)

## Available models

DS-2CD8254F-EI, DS-2CD8254F-EIS

\*-S": is equipped with audio, alarm and RS-485 interface.

# DS-2CD783F-E(I) 5 MP Network Dome Camera



## Key features

- 1/2.5" progressive scan CMOS
- H.264 / MPEG4 / MJPEG video compression
- Up to 5 megapixel (2560 x 1920) resolution
- Full HD 1080P real time video
- Day / night auto switch
- PoE
- 3-axis adjustment

## Dimensions

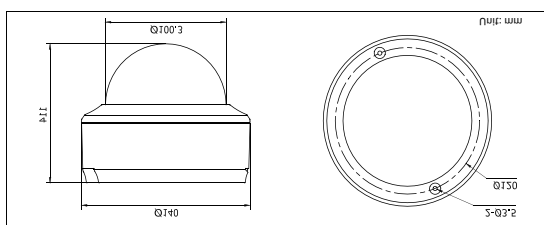

## Accessories



DS-1227ZJ  
(Indoor in-ceiling mount)



DS-1229ZJ  
(Vandal-proof wall mount)

## Specifications

DS-2CD783F-E(I)	
<b>Camera</b>	
Image sensor	1/2.5" progressive scan CMOS
Min. illumination	0.6 lux@F1.2, AGC on 0.7 lux@F1.6, AGC on -I: 0.6 lux@F1.2, AGC on, 0 lux with IR 0.7 lux@F1.6, AGC on, 0 lux with IR
Shutter time	1/25s ~ 1/100,000s
Lens	4.5 ~ 10 mm @F1.6 Angle of view: 71.5° ~ 33.5°
Lens mount	Φ17.5
Auto iris	DC drive
Angle adjustment	Pan: 0° ~ 360°, tilt: 0° ~ 75°, rotation: 0° ~ 360°
Day & night	Electronic (-I: IR cut filter with auto switch)
<b>Compression Standard</b>	
Video compression	H.264 / MPEG4 / MJPEG
Bit rate	32 Kbps ~ 16 Mbps
Audio compression	G.711
Dual stream	Yes
<b>Image</b>	
Max. image resolution	2560 × 1920
Frame rate	50 Hz: 6.25 fps (2560 × 1920) 12.5 fps (2048 × 1536) 25 fps (1920 × 1080) 25 fps (1600 × 1200) 25 fps (1280 × 720) 60 Hz: 7.5 fps (2560 × 1920) 15 fps (2048 × 1536) 30 fps (1920 × 1080) 30 fps (1600 × 1200) 30 fps (1280 × 720)
Image settings	Saturation, brightness, contrast adjustable through client software or web browser
<b>Network</b>	
Network storage	NAS (iSCSI optional)
Alarm trigger	Motion detection, network disconnect, IP address conflict, storage exception
Protocols	TCP/IP, HTTP, DHCP, DNS, DDNS, RTP/RTSP, PPPoE, SMTP, NTP (SNMP, HTTPS, SIP, FTP, SRTP, 802.1x, IPv6 optional)
Security	Password protection, watermark
System compatibility	ONVIF, PSIA, CGI
<b>Interface</b>	
Audio input	1-ch microphone input, 3.5 mm mini-jack
Audio output	1-ch 3.5 mm audio interface (line level, 600 Ω)
Communication interface	1 RJ45 10M / 100M ethernet port and 1 RS-485 interface
Alarm input	2
Alarm output	2
Video output	1 Vp-p composite output (75 Ω / RCA)
Local storage	Built-in SD/SDHC slot, up to 32 GB
Reset button	Yes
<b>General</b>	
Operating conditions	-10°C ~ 60°C (14°F ~ 140°F), humidity 90% or less (non-condensing)
Power supply	12 VDC ± 10%, PoE (802.3af)
Power consumption	5.5W max. -I: 7W max. (7.5W max. with IR cut filter on)
Impact protection	IEC60068-275Eh, 50J; EN50102, up to IK10
IR range	-I: approx. 10 ~ 20m
Dimensions	Φ 140 × 114 mm (Φ 5.51" × 4.49")
Weight	1400g (3.09 lbs)

## Available models

DS-2CD783F-E, DS-2CD783F-EI

# DS-2CD754F-E(I) 3 MP Network Dome Camera

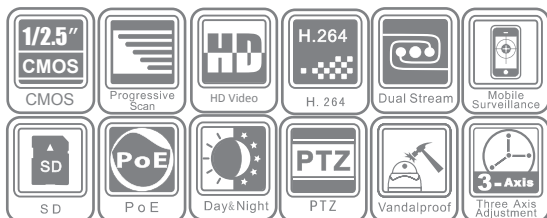

## Key features

- 1/2.5" progressive scan CMOS
- H.264 / MPEG4 / MJPEG video compression
- Up to 3 megapixel (2048 x 1536) resolution
- Full HD 1080P real time video
- Day / night auto switch
- PoE
- 3-axis adjustment

## Dimensions

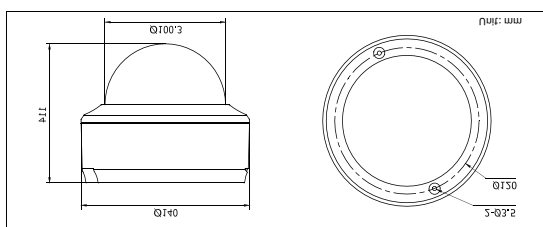

## Accessories



DS-1227ZJ  
(Indoor in-ceiling mount)



DS-1229ZJ  
(Vandal-proof wall mount)

## Specifications

DS-2CD754F-E(I)	
<b>Camera</b>	
Image sensor	1/2.5" progressive scan CMOS
Min. illumination	0.6 lux@F1.2, AGC on 0.7 lux@ (F1.6, AGC on -I: 0.6 lux@F1.2, AGC on, 0 lux with IR 0.7 lux@F1.6, AGC on, 0 lux with IR
Shutter time	1/25s ~ 1/100,000s
Lens	2.7 ~ 9 mm @F1.6 Angle of view: 94.7° ~ 28.6°
Lens mount	Φ14
Auto iris	DC drive
Angle adjustment	Pan: 0° ~ 360°, tilt: 0° ~ 75°, rotation: 0° ~ 360°
Day & night	Electronic (-I: IR cut filter with auto switch)
<b>Compression standard</b>	
Video compression	H.264 / MPEG4 / MJPEG
Bit rate	32 Kbps ~ 16 Mbps
Audio compression	G.711
Dual stream	Yes
<b>Image</b>	
Max. image resolution	2048 × 1536
Frame rate	50 Hz: 12.5 fps (2048 × 1536) 25 fps (1920 × 1080) 25 fps (1600 × 1200) 60 Hz: 15 fps (2048 × 1536) 30 fps (1920 × 1080) 30 fps (1600 × 1200)
Image settings	Saturation, brightness, contrast adjustable through client software or web browser
<b>Network</b>	
Network storage	NAS ( iSCSI optional)
Alarm trigger	Motion detection, network disconnect , IP address conflict, storage exception
Protocols	TCP/IP, HTTP, DHCP, DNS, DDNS, RTP/RTSP, PPPoE, SMTP, NTP (SNMP, HTTPS, SIP, FTP, SRTP, 802.1x, IPv6 optional)
Security	Password protection, watermark
System compatibility	ONVIF, PSIA, CGI
<b>Interface</b>	
Audio input	1-ch microphone input, 3.5 mm mini-jack
Audio output	1-ch 3.5 mm audio interface (line level, 600 Ω)
Communication interface	1 RJ45 10M / 100M ethernet port and 1 RS-485 interface
Alarm input	2
Alarm output	2
Video output	1 Vp-p composite output (75 Ω / RCA)
Local storage	Built-in SD/SDHC slot, up to 32 GB
Reset button	Yes
<b>General</b>	
Operating conditions	-10°C ~ 60°C (14°F ~ 140°F) Humidity 90% or less (non-condensing)
Power supply	12 VDC ± 10%, PoE (802.3af)
Power consumption	5.5W max. -I: 7W max. (7.5W max. with IR cut filter on)
Impact protection	IEC60068-275Eh, 50J; EN50102, up to IK10
IR range	-I: approx 10 to 20 meters
Dimensions	Φ 140 × 114 mm (Φ 5.51" × 4.49")
Weight	1400g (3.09 lbs)

## Available models

DS-2CD754F-E, DS-2CD754F-EI

# DS-2CD754FWD-E(I) 2 MP WDR Network Dome Camera

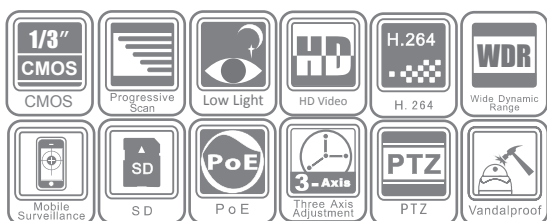

## Key features

- 1/3" progressive scan CMOS
- H.264 / MPEG4 / MJPEG video compression
- Up to 2 megapixel (1920 × 1080) resolution
- Full HD1080P real time video
- 120 dB wide dynamic range
- True day / night
- PoE
- 3-axis adjustment

## Dimensions

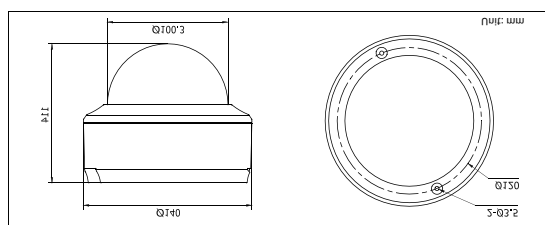

## Accessories



DS-1227ZJ  
(Indoor in-ceiling mount)



DS-1229ZJ  
(Vandal-proof wall mount)

## Specifications

DS-2CD754FWD-E(I)	
<b>Camera</b>	
Image sensor	1/3" progressive scan CMOS
Min. illumination	0.1 lux@F1.6, AGC on -I: 0.1 lux@F1.6, AGC on, 0 lux with IR
Shutter time	1/25s ~ 1/100,000s
Lens	2.7 ~ 9 mm @F1.6 Angle of view: 101° ~ 30.4°
Lens mount	Φ14
Auto iris	DC drive
Angle adjustment	Pan: 0° ~ 360°, tilt: 0° ~ 75°, rotation: 0° ~ 360°
Day & night	Electronic (-I: IR cut filter with auto switch)
Wide dynamic range	120 dB
<b>Compression standard</b>	
Video compression	H.264 / MPEG4 / MJPEG
Bit rate	32 Kbps ~ 16 Mbps
Audio compression	G.711
Dual stream	Yes
<b>Image</b>	
Max. image resolution	1920 x 1080
Frame rate	50 Hz: 25 fps (1920 × 1080) 25 fps (1280 × 720) 60 Hz: 30 fps (1920 × 1080) 30 fps (1280 × 720)
Image settings	Saturation, brightness, contrast adjustable through client software or web browser
<b>Network</b>	
Network storage	NAS (iSCSI optional)
Alarm trigger	Motion detection, network disconnect, IP address conflict, storage exception
Protocols	TCP/IP, HTTP, DHCP, DNS, DDNS, RTP/RTSP, PPPoE, SMTP, NTP (SNMP, HTTPS, SIP, FTP, SRTP, 802.1x, IPv6 optional)
Security	Password protection, watermark
System compatibility	ONVIF, PSIA, CGI
<b>Interface</b>	
Audio input	1-ch microphone input, 3.5 mm mini-jack
Audio output	1-ch 3.5 mm audio interface (line level, 600 Ω)
Communication interface	1 RJ45 10M / 100M ethernet port and 1 RS-485 interface
Alarm input	2
Alarm output	2
Video output	1 Vp-p composite output (75 Ω / RCA)
Local storage	Built-in SD/SDHC slot, up to 32 GB
Reset button	Yes
<b>General</b>	
Operating conditions	-10°C ~ 60°C (14°F ~ 140°F) Humidity 90% or less (non-condensing)
Power supply	12 VDC ± 10% , PoE (802.3af)
Power consumption	5.5W max. -I: 7W max. (7.5W max. with IR cut filter on)
Impact protection	IEC60068-2-75Eh, 50J; EN50102, up to IK10
IR range	-I: approx. 10 ~ 20m
Dimensions	Φ 140 × 114 mm (Φ 5.51" × 4.49")
Weight	1400g (3.09 lbs)

## Available Models

DS-2CD754FWD-E, DS-2CD754FWD-EI

# DS-2CD753F-E(I) 2 MP Network Dome Camera

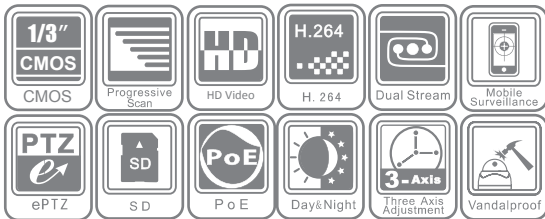

## Key features

- 1/3" progressive scan CMOS
- H.264 / MPEG4 / MJPEG video compression
- Up to 2 megapixel (1600 x 1200) resolution
- HD 720P real time video
- Day / night auto switch
- PoE
- 3-axis adjustment

## Dimensions

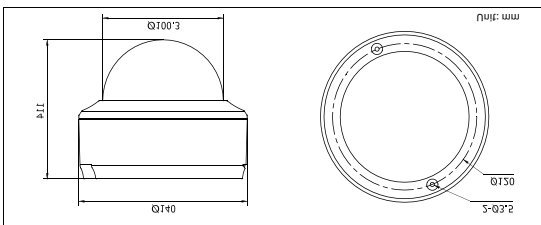

## Accessories



DS-1227ZJ  
(Indoor in-ceiling mount)



DS-1229ZJ  
(Vandal-proof wall mount)

## Specifications

DS-2CD753F-E(I)	
<b>Camera</b>	
Image sensor	1/3" progressive scan CMOS
Min. illumination	0.5 lux@F1.2, AGC on, 0.1 lux@F1.2, AGC on, sens-up × 5 -: 0.5 lux@F1.2, AGC on, 0.1 lux@F1.2, AGC on, sens-up × 5 0 lux with IR
Shutter time	1/25s ~ 1/100,000s
Lens	2.7 ~ 9 mm @F1.2 Angle of view: 101° ~ 30.4°
Lens mount	Φ14
Auto iris	DC drive
Angle adjustment	Pan: 0° ~ 360°, tilt: 0° ~ 75°, rotation: 0° ~ 360°
Day & night	Electronic (-: IR cut filter with auto switch)
<b>Compression Standard</b>	
Video compression	H.264 / MPEG4 / MJPEG
Bit rate	32 Kbps ~ 16 Mbps
Audio compression	G.711
Dual stream	Yes
<b>Image</b>	
Max. image resolution	1600 x 1200
Frame rate	50 Hz: 12.5 fps (1600 × 1200) 12.5 fps (1600 × 912) 25 fps (1280 × 960) 25 fps (1280 × 720) 60 Hz: 15 fps (1600 × 1200) 15 fps (1600 × 912) 25 fps (1280 × 960) 30 fps (1280 × 720)
Image settings	Saturation, brightness, contrast adjustable through client software or web browser
<b>Network</b>	
Network storage	NAS (iSCSI optional)
Alarm trigger	Motion detection, network disconnect, IP address conflict, storage exception
Protocols	TCP/IP, HTTP, DHCP, DNS, DDNS, RTP/RTSP, PPPoE, SMTP, NTP (SNMP, HTTPS, SIP, FTP, SRTP, 802.1x, IPv6 optional)
Security	Password protection, watermark
System compatibility	ONVIF, PSIA, CGI
<b>Interface</b>	
Audio input	1-ch microphone input, 3.5 mm mini-jack
Audio output	1-ch 3.5 mm audio interface (line level, 600 Ω)
Communication interface	1 RJ45 10M / 100M ethernet port and 1 RS-485 interface
Alarm input	2
Alarm output	2
Video output	1 Vp-p composite output (75 Ω / RCA)
Local storage	Built-in SD/SDHC slot, up to 32 GB
Reset button	Yes
<b>General</b>	
Operating conditions	-10°C ~ 60°C (14°F ~ 140°F) Humidity 90% or less (non-condensing)
Power supply	12 VDC ± 10%, PoE (802.3af)
Power consumption	4.5W max. -: 6W max. (6.5W max. with IR cut filter on)
Impact protection	IEC60068-275Eh, 50J; EN50102, up to IK10
IR range	-: approx. 10 ~ 20m
Dimensions	Φ 140 × 114 mm (Φ 5.51" × 4.49")
Weight	1400g (3.09 lbs)

## Available models

DS-2CD753F-E, DS-2CD753F-EI

# DS-2CD763P(N)F-E(I) 1.3 MP Network Dome Camera



### Key features

- 1/3" Sony progressive scan CCD
- H.264 / MPEG4 / MJPEG video compression
- Up to 1.3 megapixel (1280 x 960) resolution
- HD720P real time video
- Day / night auto switch
- PoE
- 3-axis adjustment

### Dimensions

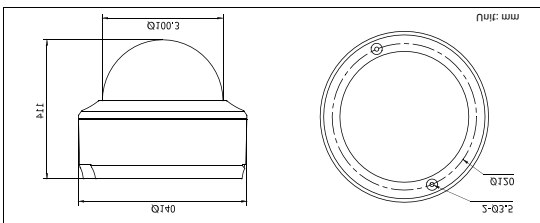

### Accessories



DS-1227ZJ  
(Indoor in-ceiling mount)



DS-1229ZJ  
(Vandal-proof wall mount)

### Specifications

DS-2CD763PF-E(I) / DS-2CD763NF-E(I)	
<b>Camera</b>	
Image sensor	1/3" Sony progressive scan CCD
Signal system	PAL / NTSC
Min. illumination	0.1 lux@F1.2, AGC on -I: 0.1 lux@F1.2, AGC on, 0 lux with IR
Shutter time	1/25 (1/30)s ~ 1/100,000s
Lens	2.7 ~ 9 mm @F1.2 Angle of view: 101° ~ 30.4°
Lens mount	Φ14
Auto iris	DC drive
Angle adjustment	Pan: 0° ~ 360°, tilt: 0° ~ 75°, rotation: 0° ~ 360°
Day & night	Electronic (-I: IR cut filter with auto switch)
<b>Compression Standard</b>	
Video compression	H.264 / MPEG4 / MJPEG
Bit rate	32 Kbps ~ 16 Mbps
Audio compression	G.711
Dual stream	Yes
<b>Image</b>	
Max. image resolution	1280 x 960
Frame rate	50 Hz: 12.5 fps (1280 × 960) 25 fps (1280 × 720) 60 Hz: 15 fps (1280 × 960) 30 fps (1280 × 720)
Image settings	Saturation, brightness, contrast adjustable through client software or web browser
<b>Network</b>	
Network storage	NAS (iSCSI optional)
Alarm trigger	Motion detection, network disconnect , IP address conflict, storage exception
Protocols	TCP/IP, HTTP, DHCP, DNS, DDNS, RTP/RTSP, PPPoE, SMTP, NTP (SNMP, HTTPS, SIP, FTP, SRTP, 802.1x, IPv6 optional)
Security	Password protection, watermark
System compatibility	ONVIF, PSIA, CGI
<b>Interface</b>	
Audio input	1-ch microphone input, 3.5 mm mini-jack
Audio output	1-ch 3.5 mm audio interface (line level, 600 Ω)
Communication interface	1 RJ45 10M / 100M ethernet port and 1 RS-485 interface
Alarm input	2
Alarm output	2
Video output	1 Vp-p composite output (75 Ω / RCA)
Local storage	Built-in SD/SDHC slot, up to 32 GB
Reset button	Yes
<b>General</b>	
Operating conditions	-10°C ~ 60°C (14°F ~ 140°F) Humidity 90% or less (non-condensing)
Power supply	12 VDC ± 10%, PoE (802.3af)
Power consumption	7.5W max. -I: 9W max. (9.5W max. with IR cut filter on)
Impact protection	IEC60068-275Eh, 50J; EN50102, up to IK10
IR range	-I: approx. 10 ~ 20m
Dimensions	Φ 140 × 114 mm (Φ 5.51" × 4.49")
Weight	1400g (3.09 lbs)

### Available models

DS-2CD763PF-E, DS-2CD763NF-E, DS-2CD763PF-EI, DS-2CD763NF-EI

# DS-2CD793P(N)FWD-E(I) 4CIF WDR Network Dome Camera

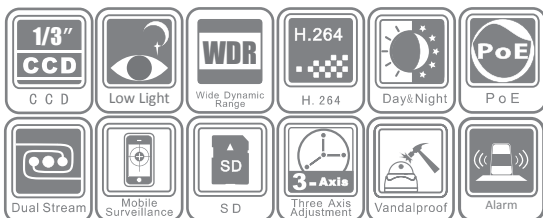

## Key features

- 1/3" Sony vertical double density interline CCD
- H.264 / MPEG4 / MJPEG video compression
- 160x wide dynamic range
- 4CIF real time video
- Day / night auto switch
- PoE
- 3-axis adjustment

## Dimensions

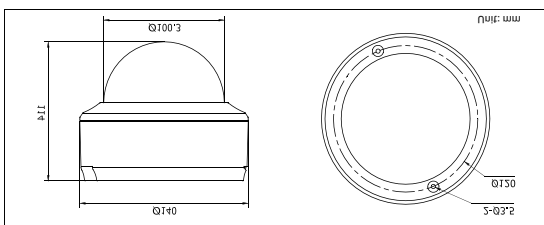

## Accessories



DS-1227ZJ  
(Indoor in-ceiling mount)



DS-1229ZJ  
(Vandal-proof wall mount)

## Specifications

DS-2CD793PFWD-E(I) / DS-2CD793NFWD-E(I)	
<b>Camera</b>	
Image sensor	1/3" Sony vertical double density interline CCD
Signal system	PAL / NTSC
Min. illumination	0.1 lux@F1.2, AGC on 0.14 lux@F1.4, AGC on -I: 0.1 lux@F1.2, AGC on, 0 lux with IR 0.14 lux @F1.4, AGC on, 0 lux with IR
Shutter time	1/25 (1/30)s ~ 1/100,000s
Lens	2.8 ~ 11 mm @F1.4 Angle of view: 97° ~ 24°
Lens mount	Φ 14
Auto iris	DC drive
Angle adjustment	Pan: 0° ~ 360°, tilt: 0° ~ 75°, rotation: 0° ~ 360°
Day & night	Electronic (-I: IR cut filter with auto switch)
Wide dynamic range	160x
<b>Compression Standard</b>	
Video compression	H.264 / MPEG4 / MJPEG
Bit rate	32 Kbps ~ 8 Mbps
Audio compression	G.711
Dual stream	Yes
<b>Image</b>	
Max. image resolution	PAL: 704 × 576, NTSC: 704 × 480
Frame rate	50 Hz: 25 fps (704 × 576) 60 Hz: 30 fps (704 × 480)
Image settings	Saturation, brightness, contrast adjustable through client software or web browser
<b>Network</b>	
Network storage	NAS ( iSCSI optional)
Alarm trigger	Motion detection, network disconnect , IP address conflict, storage exception
Protocols	TCP/IP, HTTP, DHCP, DNS, DDNS, RTP/RTSP, PPPoE, SMTP, NTP (SNMP, HTTPS, SIP, FTP, SRTP, 802.1x, IPv6 optional)
Security	Password protection, watermark
System compatibility	ONVIF, PSIA, CGI
<b>Interface</b>	
Audio input	1-ch microphone input, 3.5 mm mini-jack
Audio output	1-ch 3.5 mm audio interface (line level, 600 Ω)
Communication interface	1 RJ45 10M / 100M ethernet port and 1 RS-485 interface
Alarm input	2
Alarm output	2
Video output	1 Vp-p composite output (75 Ω / RCA)
Local storage	Built-in SD/SDHC slot, up to 32 GB
Reset button	Yes
<b>General</b>	
Operating conditions	-10°C ~ 60°C (14°F ~ 140°F) Humidity 90% or less (non-condensing)
Power supply	12 VDC ± 10% , PoE (802.3af)
Power consumption	5.5W max. -I: 7W max. (7.5W max. with IR cut filter on)
Impact protection	IEC60068-275Eh, 50J; EN50102, up to IK10
IR range	-I: approx. 10 ~ 20m
Dimensions	Φ 140 × 114 mm ( Φ 5.51" × 4.49")
Weight	1400g (3.09 lbs)

## Available models

DS-2CD793PFWD-E, DS-2CD793NFWD-E, DS-2CD793PFWD-EI, DS-2CD793NFWD-EI



# DS-2CD793P(N)F-E(I) 4CIF Network Dome Camera



## Key features

- High performance 1/3" Sony CCD
- H.264 / MPEG4 / MJPEG video compression
- Super low illumination
- 4CIF real time video
- Day / night auto switch
- PoE
- 3-axis adjustment

## Dimensions

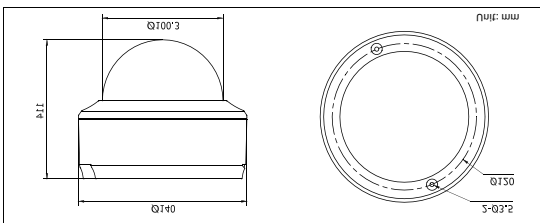

## Accessories



DS-1227ZJ  
(Indoor in-ceiling mount)



DS-1229ZJ  
(Vandal-proof wall mount)

## Specifications

DS-2CD793PF-E(I) / DS-2CD793NF-E(I)	
<b>Camera</b>	
Image sensor	1/3" Sony CCD
Signal system	PAL / NTSC
Min. illumination	0.02 lux@F1.2, AGC on, 0.027 lux@F1.4, AGC on -I: 0.02 lux@F1.2, AGC on, 0 lux with IR 0.027 lux@F1.4, AGC on, 0 lux with IR
Shutter time	1/25 (1/30)s ~ 1/100,000s
Lens	2.8 ~ 11 mm @F1.4 Angle of view: 97° ~ 24°
Lens mount	Φ 14
Auto iris	DC drive
Angle adjustment	Pan: 0° ~ 360°, tilt: 0° ~ 75°, rotation: 0° ~ 360°
Day & night	Electronic (-I: IR cut filter with auto switch)
<b>Compression Standard</b>	
Video compression	H.264 / MPEG4 / MJPEG
Bit rate	32 Kbps ~ 8 Mbps
Audio compression	G.711
Dual stream	Yes
<b>Image</b>	
Max. image resolution	PAL: 704 × 576, NTSC: 704 × 480
Frame rate	50 Hz: 25 fps (704 × 576) 60 Hz: 30 fps (704 × 480)
Image settings	Saturation, brightness, contrast adjustable through client software or web browser
<b>Network</b>	
Network storage	NAS (iSCSI optional)
Alarm trigger	Motion detection, network disconnect, IP address conflict, storage exception
Protocols	TCP/IP, HTTP, DHCP, DNS, DDNS, RTP/RTSP, PPPoE, SMTP, NTP (SNMP, HTTPS, SIP, FTP, SRTP, 802.1x, IPv6 optional)
Security	Password protection, watermark
System compatibility	ONVIF, PSIA, CGI
<b>Interface</b>	
Audio input	1-ch microphone input, 3.5 mm mini-jack
Audio output	1-ch 3.5 mm audio interface (line level, 600 Ω)
Communication interface	1 RJ45 10M / 100M ethernet port and 1 RS-485 interface
Alarm input	2
Alarm output	2
Video output	1 Vp-p composite output (75 Ω / RCA)
Local storage	Built-in SD/SDHC slot, up to 32 GB
Reset button	Yes
<b>General</b>	
Operating conditions	-10°C ~ 60°C (14°F ~ 140°F) Humidity 90% or less (non-condensing)
Power supply	12 VDC ± 10% , PoE (802.3af)
Power consumption	5.5W max. -I: 7W max. (7.5W max. with IR cut filter on)
Impact protection	IEC60068-275Eh, 50J; EN50102, up to IK10
IR range	-I: approx. 10 ~ 20m
Dimensions	Φ 140 × 114 mm (Φ 5.51" × 4.49")
Weight	1400g (3.09 lbs)

## Available models

DS-2CD793PF-E, DS-2CD793NF-E, DS-2CD793PF-EI, DS-2CD793NF-EI

# DS-2CD702/712P(N)F-E Network Dome Camera



## Key features

- High performance 1/3" Sony CCD
- H.264 video compression
- Low illumination: 0.1 lux
- Day / night auto switch
- PoE
- 3-axis adjustment

## Dimensions

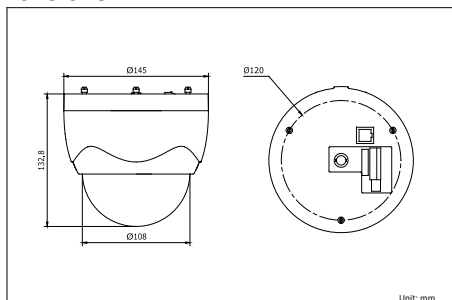

## Accessories



DS-1611ZJ  
(Wall Mount)



DS-1612ZJ  
(In-ceiling Mount)

## Specifications

	DS-2CD702PF (NF) -E	DS-2CD712PF (NF) -E
<b>Camera</b>		
Image sensor	1/3" Sony CCD	
Signal system	PAL / NTSC	
Min. illumination	0.1 lux@F1.2, AGC on	
Shutter time	1/50 (1/60)s ~ 1/100,000s	
Lens	3.5 ~ 9 mm @F1.2 Angle of view: 80° ~ 30°	
Lens mount	Φ14	
Angle adjustment	Pan: 0 ~ 355°, tilt: 0 ~ 75°, rotation: 0 ~ 180°	
Day & night	Electronic	
Horizontal resolution	420 TVL	480 TVL
<b>Compression standard</b>		
Video compression	H.264 (MPEG-4 optional)	
Bit rate	32 Kbps ~ 8 Mbps	
Audio compression	OggVorbis	
Dual stream	Yes	
<b>Image</b>		
Max. image resolution	PAL: 704 × 576, NTSC: 704 × 480	
Frame rate	50 Hz: 25 fps (704 × 576) 60 Hz: 30 fps (704 × 480)	
Image settings	Saturation, brightness, contrast adjustable through client software or web browser	
<b>Network</b>		
Network storage	NAS (iSCSI optional)	
Alarm trigger	Motion detection, network disconnect, IP address conflict, storage exception	
Protocols	TCP/IP, HTTP, DHCP, DNS, DDNS, RTP/RTSP, PPPoE, SMTP, NTP (SNMP, HTTPS, SIP, FTP, SRTP, 802.1x, IPv6 optional)	
Security	Password protection, watermark	
System compatibility	ONVIF, PSIA, CGI	
<b>Interface</b>		
Audio input	1-ch, line level, 2.0 ~ 2.4 Vp-p, 1 kΩ	
Audio output	1-ch, line level, 600 Ω	
Communication interface	1 RJ45 10M / 100M ethernet port and 1 RS-485 interface	
Alarm input	1	
Alarm output	1	
Video output	1 Vp-p composite output (75 Ω / BNC)	
Local storage	Built-in SD/SDHC slot, up to 32 GB	
<b>General</b>		
Operating conditions	-10°C ~ 60°C (14°F ~ 140°F) Humidity 90% or less (non-condensing)	
Power supply	12 VDC ± 10%, PoE (802.3af)	
Power consumption	4W max.	
Dimensions	Φ 145 × 132.8 mm (Φ 5.71" × 5.23")	
Weight	900g (1.98 lbs)	

## Available models

DS-2CD702PF-E, DS-2CD702NF-E, DS-2CD712PF-E, DS-2CD712NF-E

# DS-2CD733F-E(I) VGA Network Dome Camera

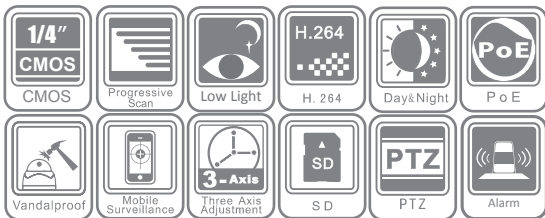

## Key features

- 1/4" progressive scan CMOS
- H.264 / MPEG4 / MJPEG video compression
- Super low illumination
- Day / night auto switch
- PoE
- 3-axis adjustment

## Dimensions

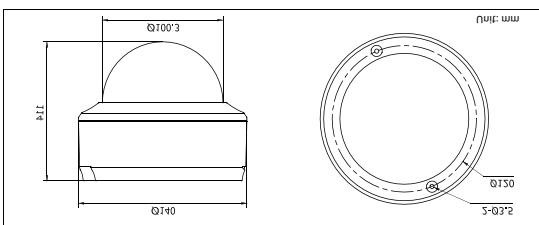

## Accessories



DS-1227ZJ  
(Indoor in-ceiling mount)



DS-1229ZJ  
(Vandal-proof wall mount)

## Specifications

DS-2CD733F-E(I)	
<b>Camera</b>	
Image sensor	1/4" progressive scan CMOS
Min. illumination	0.01 lux@F1.2, AGC on 0.014 lux@F1.4, AGC on -I: 0.01 lux@F1.2, AGC on, 0 lux with IR 0.014 lux@F1.4, AGC on, 0 lux with IR
Shutter time	1/25s ~ 1/100,000s
Lens	2.8 ~ 11 mm @F1.4 Angle of view: 70° ~ 18°
Lens mount	Φ14
Auto iris	DC drive
Angle adjustment	Pan: 0° ~ 360°, tilt: 0° ~ 75°, rotation: 0° ~ 360°
Day & night	Electronic(-I: IR cut filter with auto switch)
<b>Compression Standard</b>	
Video compression	H.264 / MPEG4 / MJPEG
Bit rate	32 Kbps ~ 8 Mbps
Audio compression	G.711
Dual stream	Yes
<b>Image</b>	
Max. image resolution	640 × 480
Frame rate	50 Hz: 25 fps (640 × 480) 60 Hz: 30 fps (640 × 480)
Image settings	Saturation, brightness, contrast adjustable through client software or web browser
<b>Network</b>	
Network storage	NAS (iSCSI optional)
Alarm trigger	Motion detection, network disconnect, IP address conflict, storage exception
Protocols	TCP/IP, HTTP, DHCP, DNS, DDNS, RTP/RTSP, PPPoE, SMTP, NTP (SNMP, HTTPS, SIP, FTP, SRTSP, 802.1x, IPv6 optional)
Security	Password protection, watermark
System compatibility	ONVIF, PSIA, CGI
<b>Interface</b>	
Audio input	1-ch microphone input, 3.5 mm mini-jack
Audio output	1-ch 3.5 mm audio interface (line level, 600 Ω)
Communication interface	1 RJ45 10M / 100M ethernet port and 1 RS-485 interface
Alarm input	2
Alarm output	2
Video output	1 Vp-p composite output (75 Ω / RCA)
Local storage	Built-in SD/SDHC slot, up to 32 GB
Reset button	Yes
<b>General</b>	
Operating conditions	-10°C ~ 60°C (14°F ~ 140°F) Humidity 90% or less (non-condensing)
Power supply	12 VDC ± 10%, PoE (802.3af)
Power consumption	4.5W max. -I: 6W max. (6.5W max. with IR cut filter on)
Impact protection	IEC60068-275Eh, 50J; EN50102, up to IK10
IR range	-I: approx. 10 ~ 20m
Dimensions	Φ 140 × 114 mm (Φ 5.51" × 4.49")
Weight	1400g (3.09 lbs)

## Available Models

DS-2CD733F-E, DS-2CD733F-EI

# DS-2CD7153-E 2 MP Network Mini Dome Camera



## Key features

- 1/3" progressive scan CMOS
- H.264 / MPEG4 / MJPEG video compression
- Up to 2 megapixel resolution
- HD 720P real time video
- Day / night auto switch
- PoE
- 3-axis adjustment

## Dimensions

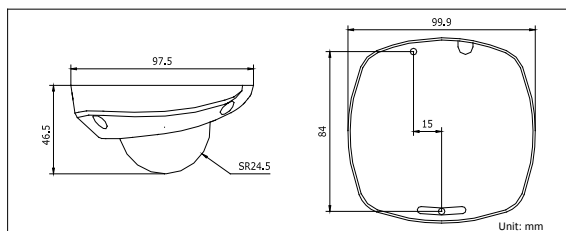

## Specifications

DS-2CD7153-E	
<b>Camera</b>	
Image sensor	1/3" progressive scan CMOS
Min. illumination	0.5 lux@F1.2, AGC on, 0.1 lux@F1.2, AGC on, sens-up × 5 1.1 lux@F1.8, AGC on, 0.2 lux@F1.8, AGC on, sens-up × 5
Shutter time	1/25s ~ 1/100,000s
Lens	4 mm @F1.8 (2.8, 6, 8mm optional) Angle of view: 71°
Lens mount	M12
Angle adjustment	Pan: ± 15°, tilt: 0 ~ 90°, rotation: ± 15°
Day & night	Electronic
<b>Compression standard</b>	
Video compression	H.264 / MPEG4 / MJPEG
Bit rate	32 Kbps ~ 16 Mbps
Dual stream	Yes
<b>Image</b>	
Max. image resolution	1600 x 1200
Frame rate	50 Hz: 12.5 fps (1600 × 1200) 12.5 fps (1600 × 912) 25 fps (1280 × 960) 25 fps (1280 × 720) 60 Hz: 15 fps (1600 × 1200) 15 fps (1600 × 912) 25 fps (1280 × 960) 30 fps (1280 × 720)
Image settings	Saturation, brightness, contrast adjustable through client software or web browser
<b>Network</b>	
Network storage	NAS (iSCSI optional)
Alarm trigger	Motion detection
Protocols	TCP/IP, HTTP, DHCP, DNS, DDNS, RTP/RTSP, PPPoE, SMTP, NTP (SNMP, HTTPS, SIP, FTP, SRTP, 802.1x, IPv6 optional)
Security	Password protection, watermark
System compatibility	ONVIF, PSIA, CGI
<b>Interface</b>	
Communication interface	1 RJ45 10M / 100M ethernet port
Reset button	Yes
<b>General</b>	
Operating conditions	-10°C ~ 60°C (14°F ~ 140°F) Humidity 90% or less (non-condensing)
Power supply	12 VDC ± 10%, PoE (802.3af)
Power consumption	4W max.
Impact protection	IEC60068-275Eh, 50J; EN50102, up to IK10
Weather-proof rating	IP66
Dimensions	99.9 × 97.5 × 46.5 mm (3.93" × 3.84" × 1.83")
Weight	250g (0.55 lbs)

## Available models

DS-2CD7153-E

# DS-2CD7133-E VGA Network Mini Dome Camera

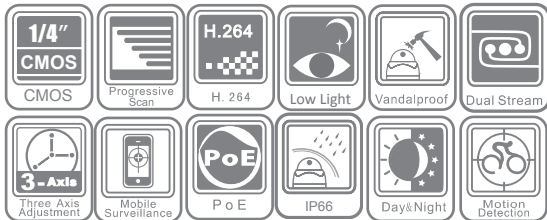

## Key features

- 1/4" progressive scan CMOS
- H.264 / MPEG4 / MJPEG video compression
- Super low illumination
- Day / night auto switch
- PoE
- IP66 rating
- 3-axis adjustment

## Dimensions

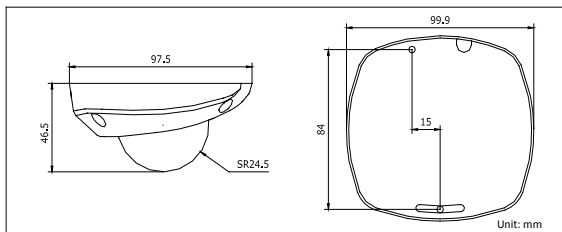

## Specifications

DS-2CD7133-E	
<b>Camera</b>	
Image sensor	1/4" progressive scan CMOS
Min. illumination	0.01 lux@F1.2, AGC on 0.02 lux@F1.8, AGC on
Shutter time	1/25s ~ 1/100,000s
Lens	4 mm @F1.8 (2.8, 6, 8mm optional) Angle of view: 54.9°
Lens mount	M12
Angle adjustment	Pan: ± 15°, tilt: 0 ~ 90°, rotation: ± 15°
Day & night	Electronic
<b>Compression Standard</b>	
Video compression	H.264 / MPEG4 / MJPEG
Bit rate	32 Kbps ~ 8 Mbps
Dual stream	Yes
<b>Image</b>	
Max. image resolution	640 × 480
Frame rate	50 Hz: 25 fps (640 × 480) 60 Hz: 30 fps (640 × 480)
Image settings	Saturation, brightness, contrast adjustable through client software or web browser
<b>Network</b>	
Network storage	NAS (iSCSI optional)
Alarm trigger	Motion detection
Protocols	TCP/IP, HTTP, DHCP, DNS, DDNS, RTP/RTSP, PPPoE, SMTP, NTP (SNMP, HTTPS, SIP, FTP, SRTP, 802.1x, IPv6 optional)
Security	Password protection, watermark
System compatibility	ONVIF, PSIA, CGI
<b>Interface</b>	
Communication interface	1 RJ45 10M / 100M ethernet port
Reset button	Yes
<b>General</b>	
Operating conditions	-10°C ~ 60°C (14°F ~ 140°F) Humidity 90% or less (non-condensing)
Power supply	12 VDC ± 10%, PoE (802.3af)
Power consumption	4W max.
Impact protection	IEC60068-275Eh, 50J; EN50102, up to IK10
Weather-proof rating	IP66
Dimensions	99.9 × 97.5 × 46.5 mm (3.93" × 3.84" × 1.83")
Weight	250g (0.55 lbs)

## Available Models

DS-2CD7133-E

# DS-2CD8153F-E 2 MP Network Cube Camera



## Specifications

DS-2CD8153F-E	
<b>Camera</b>	
Image sensor	1/3" progressive scan CMOS
Min. illumination	0.5 lux@F1.2, AGC on, 0.1 lux@F1.2, AGC on, sens-up × 5 1.1 lux@F1.8, AGC on, 0.2 lux@F1.8, AGC on, sens-up × 5
Shutter time	1/25s ~ 1/100,000s
Lens	4 mm @F1.8 Angle of view: 71°
Lens mount	M12
Day & night	Electronic
<b>Compression Standard</b>	
Video compression	H.264 / MPEG4 / MJPEG
Bit rate	32 Kbps ~ 16 Mbps
Audio compression	G.711
Dual stream	Yes
<b>Image</b>	
Max. image resolution	1600 × 1200
Frame rate	50 Hz: 12.5 fps (1600 × 1200) 12.5 fps (1600 × 912) 25 fps (1280 × 960) 25 fps (1280 × 720) 60 Hz: 15 fps (1600 × 1200) 15 fps (1600 × 912) 25 fps (1280 × 960) 30 fps (1280 × 720)
Image settings	Saturation, brightness, contrast adjustable through client software or web browser
<b>Network</b>	
Network storage	NAS (iSCSI optional)
Alarm trigger	Motion detection
Protocols	TCP/IP, HTTP, DHCP, DNS, DDNS, RTP/RTSP, PPPoE, SMTP, NTP (SNMP, HTTPS, SIP, FTP, SRTP, 802.1x, IPv6 optional)
Security	Password protection, watermark
System compatibility	ONVIF, PSIA, CGI
<b>Interface</b>	
Audio	Internal microphone and speaker
Communication interface	1 RJ45 10M / 100M ethernet port
Local storage	Built-in Micro SD slot, up to 32 GB
Reset button	Yes
<b>General</b>	
Operating conditions	-10°C ~ 60°C (14°F ~ 140°F) Humidity 90% or less (non-condensing)
Power supply	12 VDC ± 10%. PoE (802.3af)
Power consumption	4W max. -W: 5.5W max.
Dimensions	70.4 × 110 × 47.6mm (2.77" × 4.33" × 1.87")
Weight	250g (0.55 lbs)



## Key features

- 1/3" progressive scan CMOS
- H.264 / MPEG4 / MJPEG video compression
- Up to 2 megapixel resolution
- HD 720P real time video
- Day / night auto switch
- PoE
- ePTZ control

## Dimensions

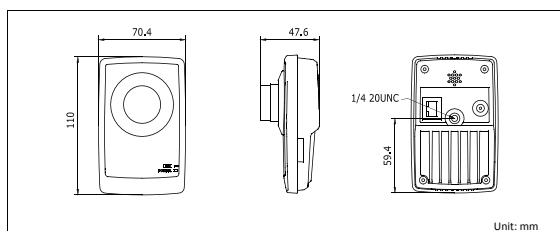

## Available models

DS-2CD8153F-E

# DS-2CD8133F-E VGA Network Cube Camera

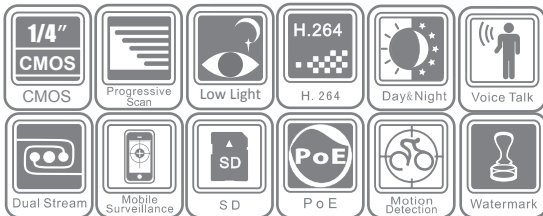

## Key features

- 1/4" progressive scan CMOS
- H.264 / MPEG4 / MJPEG video compression
- Super low illumination
- Day / night auto switch
- PoE

## Dimensions

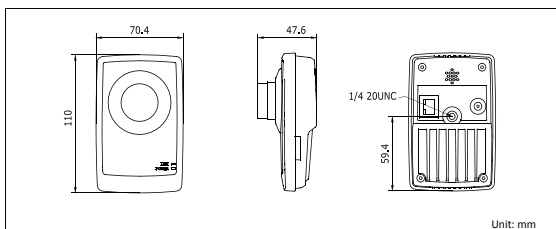

## Specifications

DS-2CD8133F-E	
<b>Camera</b>	
Image sensor	1/4" progressive scan CMOS
Min. illumination	0.01 lux@F1.2, AGC on 0.02 lux@F1.8, AGC on
Shutter time	1/25s to 1/100,000s
Lens	4 mm @F1.8 Angle of view: 54.9°
Lens mount	M12
Day & night	Electronic
<b>Compression Standard</b>	
Video compression	H.264 / MPEG4 / MJPEG
Bit rate	32 Kbps ~ 8 Mbps
Audio compression	G.711
Dual stream	Yes
<b>Image</b>	
Max. image resolution	640 × 480
Frame rate	50 Hz: 25 fps (640 × 480) 60 Hz: 30 fps (640 × 480)
Image settings	Saturation, brightness, contrast adjustable through client software or web browser
<b>Network</b>	
Network storage	NAS (iSCSI optional)
Alarm trigger	Motion detection, storage exception
Protocols	TCP/IP, HTTP, DHCP, DNS, DDNS, RTP/RTSP, PPPoE, SMTP, NTP (SNMP, HTTPS, SIP, FTP, SRTP, 802.1x, IPv6 optional)
Security	Password protection, watermark
System compatibility	ONVIF, PSIA, CGI
<b>Interface</b>	
Audio input	1-ch 3.5 mm audio interface (2.0 - 2.4 Vp-p, 1 kΩ)
Audio output	1-ch 3.5 mm audio interface (line level, 600 Ω)
Communication interface	1 RJ45 10M / 100M ethernet interface, 1 RS-485 interface, 1 RS-232 interface
Alarm input	4
Alarm output	3
Video output	1 Vp-p composite output (75 Ω / BNC)
Local storage	Built-in SD/SDHC slot, up to 32 GB
Reset button	Yes
<b>General</b>	
Operating conditions	-10°C ~ 60°C (14°F ~ 140°F) Humidity 90% or less (non-condensing)
Power supply	5 VDC ± 10%, PoE (802.3af)
Power consumption	4W max. -W: 5.5W max.
Dimensions	110 × 70 × 33mm (4.33" × 2.76" × 1.30")
Weight	250g (0.55 lbs)

## Available models

DS-2CD8133F-E

# DS-2CC1191P-A High Definition Box Camera

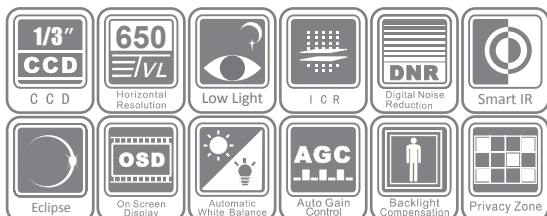

## Key Features

- 1/3" Sony EXVIEW HAD CCD II
- 650 TVL high resolution
- Super low illumination
- True day / night
- Smart IR
- Digital wide dynamic range

## Dimensions

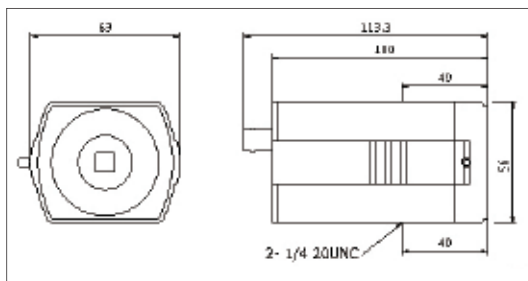

## Accessories



DS-1212ZJ (Indoor wall mount) DS-1213ZJ (Indoor/Outdoor Wall Mount) DS-1311/2/3HZ (Indoor/Outdoor camera housing) DS-1320HZ (Indoor camera housing)

## Specifications

DS-2CC1191P-A	
<b>Camera</b>	
Image sensor	1/3" Sony EXVIEW HAD CCD II
Signal system	PAL
Effective pixels	976 (H) × 582 (V)
Min. illumination	Color: 0.001 lux@F1.2, AGC on B/W: 0.0001 lux@F1.2, AGC on
Shutter time	1/50s ~ 1/100,000s
Lens mount	C/CS mount
Auto iris	DC/Video drive
Day & night	IR cut filter with auto switch
Horizontal resolution	Color: 650 TVL, B/W: 700 TVL
Synchronization	Internal / Power synchronization
Video output	1Vp-p composite output (75 Ω / BNC)
S/N ratio	More than 62dB
<b>Menu</b>	
Camera ID	On / off (16 letters, adjusted position)
Auto gain control	Low / middle / high / off
D/N mode	Auto1 / auto2 / day / night
White balance	Auto trace WB1 / auto trace WB2 / manual / auto Control
Private mask	On / off, maximum 8 zones
Motion detection	Mode 1 / mode 2 / off
BLC	Area / value / off
RS-485	Address / protocol / baud rate
Language	English / Chinese
Video	SMART IR, digital WDR, excessive highlight compensation, digital noise reduction, sharpness, brightness, saturation, resolution, mirror, defect pixel correction
<b>General</b>	
Operating conditions	-10°C ~ 60°C (14°F ~ 140°F) Humidity 90% or less (non-condensing)
Power supply	24 VAC ± 10%, 12 VDC ± 10%
Power consumption	5W max. (10W max. with IR cut filter on)
Dimensions	69 x 56 x 113.3 mm (2.72" × 2.20" × 4.46")
Weight	400g (0.88 lbs)

## Available models

DS-2CC1191P-A



# DS-2CC1193P(N)-A High Definition Box Camera

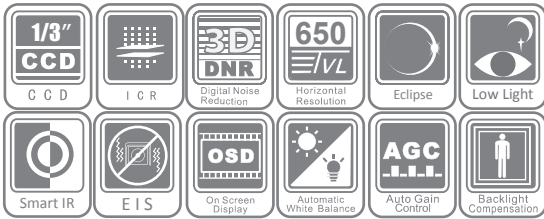

### Key Features

- 1/3" Sony EXVIEW HAD CCD II
- Low illumination
- 3D digital noise reduction
- Digital wide dynamic range
- True day / night
- Smart IR
- OSD menu

### Dimensions

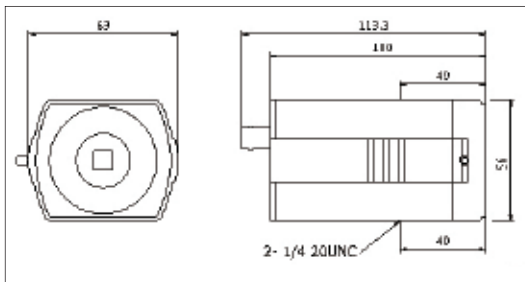

### Accessories



### Specifications

DS-2CC1193P(N)-A	
<b>Camera</b>	
Image sensor	1/3" Sony EXVIEW HAD CCD II
Signal system	PAL / NTSC
Effective pixels	PAL: 976 (H) × 582 (V) NTSC: 976 (H) × 494 (V)
Min. illumination	Color: 0.01 lux@F1.2, AGC on, 0.0001 lux@F1.2, AGC on, sens-up × 512 B/W: 0.001 lux@F1.2, AGC on, 0.00001 lux@F1.2, AGC on, sens-up × 512
Shutter time	PAL: 1/50s ~ 1/100,000s NTSC: 1/60s ~ 1/100,000s
Lens mount	C/CS mount
Auto iris	DC/Video drive
Day & night	IR cut filter with auto switch
Horizontal resolution	Color: 650 TVL, B/W: 700 TVL
Synchronization	Internal / power synchronization
Video output	1Vp-p composite output (75Ω / BNC)
S/N ratio	More than 62dB
<b>Menu</b>	
Camera ID	On / off (16 letters, adjusted position)
Auto gain control	Low / middle / high / off
D/N mode	Auto1 / auto2 / day / night
White balance	Auto trace WB1 / auto trace WB2 / manual / auto control
Private mask	On / off, maximum 12 zones
Motion detection	Mode 1 / mode 2 / off
BLC	Area / value / off
RS-485	Address / protocol / baud rate
Anti-flicker	On / off
Language	English / Chinese
Video	SMART IR, digital WDR, excessive highlight compensation, digital noise reduction, sharpness, brightness, saturation, resolution, electronic image stabilization, digital zoom, mirror, defect pixel correction
Scene	Indoor standard , indoor backlight , outdoor, low illumination , IR standard , customize
<b>General</b>	
Operating conditions	-10°C ~ 60°C (14°F ~ 140°F) Humidity 90% or less (non-condensing)
Power supply	24 VAC ± 10%, 12 VDC ± 10%
Power consumption	5W max. (10W max. with IR cut filter on)
Dimensions	69 x 56 x 113.3 mm (2.72" × 2.20" × 4.46")
Weight	400g (0.88 lbs)

### Available models

DS-2CC1193P-A, DS-2CC1193N-A

# DS-2CC1195P(N)-A Low Light Box Camera

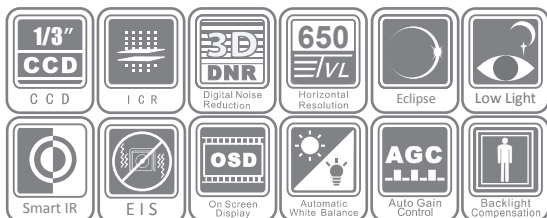

## Key Features

- 1/3" Sony EXVIEW HAD CCD II
- Super low illumination
- 3D digital noise reduction
- True day / night
- Smart IR
- OSD menu

## Dimensions

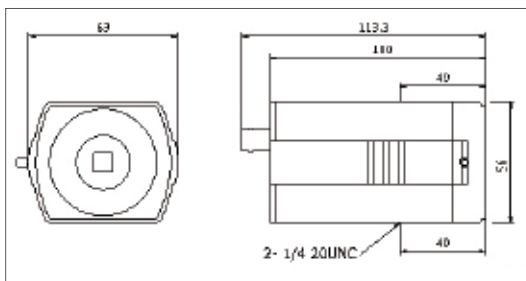

## Accessories



DS-1212ZJ (Indoor wall mount) DS-1213ZJ (Indoor/Outdoor Wall Mount) DS-13112/3HZ (Indoor/Outdoor camera housing) DS-1320HZ (Indoor camera housing)

## Specifications

DS-2CC1195P(N)-A	
<b>Camera</b>	
Image sensor	1/3" Sony EXVIEW HAD CCD II
Signal system	PAL / NTSC
Effective pixels	PAL: 976 (H) × 582 (V) NTSC: 976 (H) × 494 (V)
Min. illumination	Color: 0.001 lux@F1.2, AGC on, 0.0001 lux@F1.2, AGC on, sens-up × 512 B/W: 0.0001 lux@F1.2, AGC on, 0.00001 lux@F1.2, AGC on, sens-up × 512
Shutter time	PAL: 1/50s ~ 1/100,000s NTSC: 1/60s ~ 1/100,000s
Lens mount	C/CS mount
Auto iris	DC/Video drive
Day & night	IR cut filter with auto switch
Horizontal resolution	Color: 650 TVL, B/W: 700 TVL
Synchronization	Internal / Power synchronization
Video output	1Vp-p composite output (75 Ω / BNC)
S/N ratio	More than 62dB
<b>Menu</b>	
Camera ID	On / off (16 letters, adjusted position)
Auto gain control	Low / middle / high / off
D/N mode	Auto1 / auto2 / day / night
White balance	Auto trace WB1 / auto trace WB2 / manual / auto Control
Private mask	On / off, maximum 12 zones
Motion detection	Mode 1 / mode 2 / off
BLC	Area / value / off
RS-485	Address / protocol / baud Rate
Anti-flicker	On / off
Language	English / Chinese
Video	SMART IR, digital WDR, excessive highlight compensation, digital noise reduction, sharpness, brightness, saturation, resolution, electronic image stabilization, digital zoom, mirror, defect pixel correction
Scene	Indoor standard , indoor backlight , outdoor, low illumination , IR standard , customize
<b>General</b>	
Operating conditions	-10°C ~ 60°C (14°F ~ 140°F) Humidity 90% or less (non-condensing)
Power supply	24 VAC ± 10%, 12 VDC ± 10%
Power consumption	5W max. (10W max. with IR cut filter on)
Dimensions	69 x 56 x 113.3 mm (2.72" × 2.20" × 4.46")
Weight	400g (0.88 lbs)

## Available models

DS-2CC1195P-A, DS-2CC1195N-A

# DS-2CC1197P-A WDR Box Camera

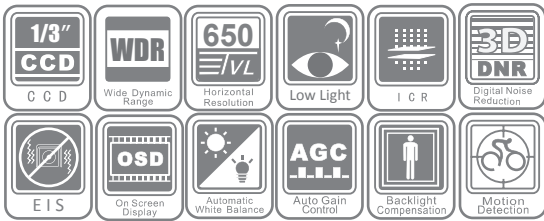

## Key Features

- 1/3" Sony Super HAD CCD II
- 650 TVL high resolution
- Super low illumination
- 75dB wide dynamic range
- 3D digital noise reduction
- True day / night

## Dimensions

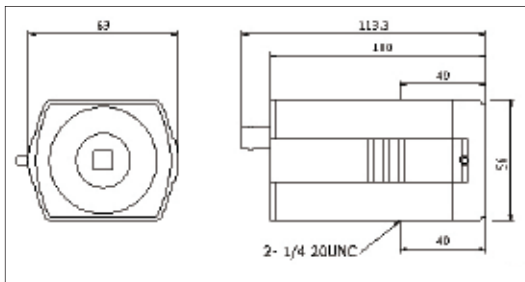

## Accessories



## Specifications

DS-2CC1197P-A	
<b>Camera</b>	
Image sensor	1/3" Sony Super HAD CCD II
Signal system	PAL
Effective pixels	976 (H) × 582 (V)
Min. illumination	Color: 0.001 lux@F1.2, AGC on, 0.0001 lux@F1.2, AGC on, sens-up × 512 B/W: 0.0001 lux@F1.2, AGC on, 0.00001 lux@F1.2, AGC on, sens-up × 512
Shutter time	1/50s ~ 1/100,000s
Lens mount	C/CS mount
Auto iris	DC/Video drive
Day & night	IR cut filter with auto switch
Horizontal resolution	Color: 650 TVL, B/W: 700 TVL
Wide dynamic range	75dB
Synchronization	Internal / Power synchronization
Video output	1Vp-p composite output (75Ω / BNC)
S/N ratio	More than 62dB
<b>Menu</b>	
Camera ID	On / off (16 letters, adjusted position)
Auto gain control	Low / middle / high / off
D/N mode	Auto1 / auto2 / day / night
White balance	Auto trace WB1 / auto trace WB2 / manual / auto control
Private mask	On / off, maximum 12 zones
Motion detection	Mode 1 / mode 2 / off
BLC	Area / value / off
WDR	Value / contrast / return
RS-485	Address / protocol / baud rate
Anti-flicker	On / off
Language	English / Chinese
Video	Digital noise reduction, sharpness, brightness, saturation, resolution, electronic image stabilization, digital zoom, mirror, defect pixel correction
Scene	Indoor standard , indoor backlight , outdoor, low illumination , customize
<b>General</b>	
Operating conditions	-10°C ~ 60°C (14°F ~ 140°F) Humidity 90% or less (non-condensing)
Power supply	24VAC ± 10%, 12VDC ± 10% (-C series support 100 ~ 240 VAC)
Power consumption	5W max. (10W max. with IR cut filter on)
Dimensions	69 x 56 x 113.3 mm (2.72" × 2.20" × 4.46")
Weight	400g (0.88 lbs)

## Available models

DS-2CC1197P-A

# DS-2CC1198P-A High Definition Box Camera

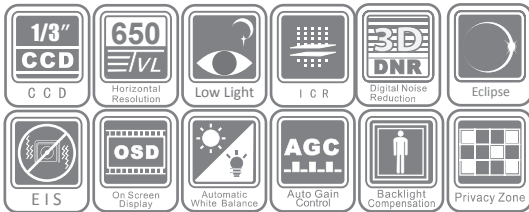
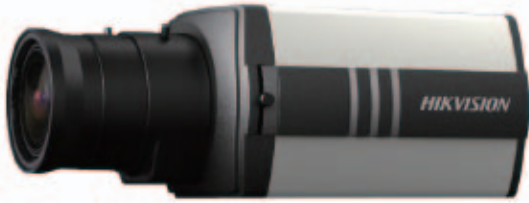

## Key Features

- 1/3" Sony EXVIEW HAD CCD II
- 650 TVL high resolution
- Super low illumination
- True day / night
- Excessive highlight compensation
- 3D digital noise reduction

## Dimensions

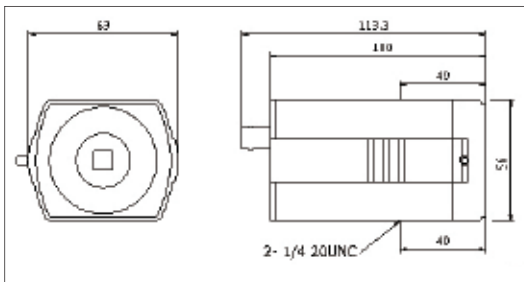

## Accessories



## Specifications

DS-2CC1198P-A	
<b>Camera</b>	
Image sensor	1/3" SONY EXView HAD CCD II
Signal system	PAL
Effective pixels	976 (H) × 582 (V)
Min. illumination	Color: 0.001 lux@F1.2, AGC on, 0.0001 lux@F1.2, AGC on, sens-up × 512 B/W: 0.0001 lux@F1.2, AGC on, 0.00001 lux@F1.2, AGC on, sens-up × 512
Shutter time	1/50s ~ 1/100,000s
Lens mount	C/CS mount
Auto iris	DC/Video drive
Day & night	IR cut filter with auto switch
Horizontal resolution	Color: 650 TVL, B/W: 700 TVL
Synchronization	Internal / Power synchronization
Video output	1Vp-p composite output (75 Ω / BNC)
S/N ratio	More than 62dB
<b>Menu</b>	
Camera ID	On / off (16 letters, adjusted position)
Auto gain control	Low / middle / high / off
D/N mode	Auto1 / auto2 / day / night
White balance	Auto trace WB1 / auto trace WB2 / manual / auto control
Private mask	On / off, maximum 12 zones
Motion detection	Mode 1 / mode 2 / off
BLC	Area / value / off
HLC	Compensation intensity
RS-485	Address / protocol / baud rate
Anti-flicker	On / off
Language	English / Chinese
Video	Digital WDR, excessive highlight compensation, digital noise reduction, sharpness, brightness, saturation, resolution, electronic image stabilization, digital zoom, mirror, defect pixel correction
Scene	Indoor backlight , outdoor backlight
<b>General</b>	
Operating conditions	-10°C ~ 60°C (14°F ~ 140°F) Humidity 90% or less (non-condensing)
Power supply	24 VAC ± 10%, 12 VDC ± 10% (-C series support 100 ~ 240 VAC)
Power consumption	5W max. (10W max. with IR cut filter on)
Dimensions	69 x 56 x 113.3 mm (2.72" × 2.20" × 4.46")
Weight	400g (0.88 lbs)

## Available models

DS-2CC1198P-A

# DS-2CC1112/1172P(-A) Box Camera

## Specifications

	DS-2CC1112P(-A)	DS-2CC1172P(-A)
<b>Camera</b>		
Image sensor	1/3" Sony Super HAD CCD II	
Signal system	PAL	
Effective pixels	752 (H) × 582 (V)	
Min. illumination	0.1 lux@F1.2, AGC on	
Shutter time	1/50s ~ 1/100,000s	
Lens mount	C/CS mount	
Auto iris	DC/Video drive	
Day & night	Electronic	
Horizontal resolution	480 TVL	540 TVL
Synchronization	Internal synchronization (-A series support Internal / Power synchronization)	
Video output	1Vp-p composite output (75 Ω / BNC)	
S/N ratio	More than 52dB	
<b>General</b>		
Operating conditions	-10°C ~ 60°C (14°F ~ 140°F) Humidity 90% or less (non-condensing)	
Power supply	12 VDC ± 10% (-A series support 24 VAC ± 10%, 12 VDC ± 10%)	
Power consumption	2W max. (-A series: 3W max.)	
Dimensions	69 x 56 x 113.3 mm (2.72" × 2.20" × 4.46")	
Weight	400g (0.88 lbs)	

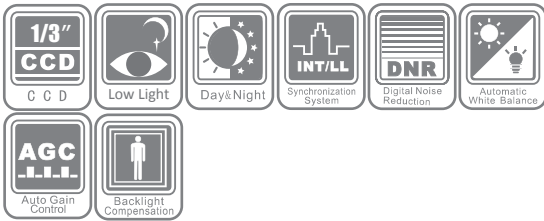

### Key Features

- 1/3" Sony Super HAD CCD II
- Low illumination
- Digital wide dynamic range
- Digital noise reduction
- Day / night auto switch

### Available models

DS-2CC1112P, DS-2CC1112P-A, DS-2CC1172P, DS-2CC1172P-A

### Dimensions

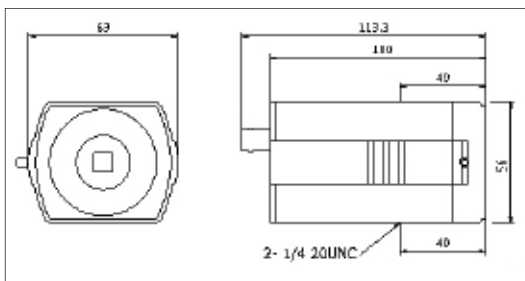

### Accessories



# DS-2CC1192P(N)(-A) Low Light Box Camera

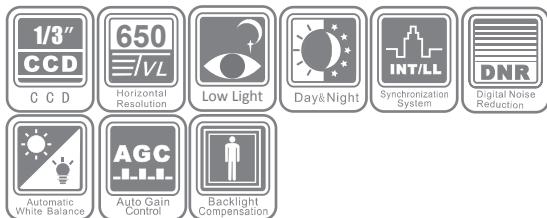

## Key Features

- 1/3" Sony EXVIEW HAD CCD II
- 650 TVL high resolution
- Super low illumination
- Digital wide dynamic range
- Digital noise reduction
- Day / night auto switch

## Specifications

DS-2CC1192P(N)(-A)	
<b>Camera</b>	
Image sensor	1/3" Sony EXVIEW HAD CCD II
Signal system	PAL / NTSC
Effective pixels	PAL: 976 (H) × 582 (V) NTSC: 976 (H) × 494 (V)
Min. illumination	0.001 lux@F1.2, AGC on
Shutter time	PAL: 1/50s ~ 1/100,000s NTSC: 1/60s ~ 1/100,000s
Lens mount	C/CS mount
Auto iris	DC/Video drive
Day & night	Electronic
Horizontal resolution	650 TVL
Synchronization	Internal synchronization (-A series support Internal / Power synchronization)
Video output	1Vp-p composite output (75 Ω / BNC)
S/N ratio	More than 62dB
<b>General</b>	
Operating conditions	-10°C ~ 60°C (14°F ~ 140°F) Humidity 90% or less (non-condensing)
Power supply	12 VDC ± 10% (-A series support 24 VAC ± 10%, 12 VDC ± 10%)
Power consumption	2W max. (-A series support 3W max.)
Dimensions	69 x 56 x 113.3 mm (2.72" × 2.20" × 4.46")
Weight	400g (0.88 lbs)

## Available models

DS-2CC1192P, DS-2CC1192N, DS-2CC1192P-A, DS-2CC1192N-A

## Dimensions

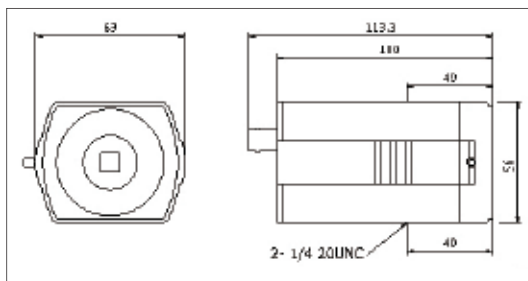

## Accessories



DS-1212ZJ (Indoor wall mount) DS-1213ZJ (Indoor/Outdoor Wall Mount) DS-1311/2/3HZ (Indoor/Outdoor camera housing) DS-1320HZ (Indoor camera housing)

# DS-2CC176P-A(-C) Box Camera

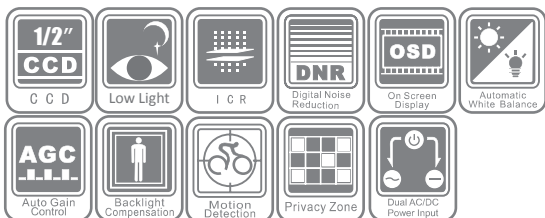

## Key Features

- 1/2" Sony EXVIEW HAD CCD
- 540 TVL resolution
- Super low illumination
- OSD menu
- Digital noise reduction
- True day / night
- Highlight compensation

## Dimensions

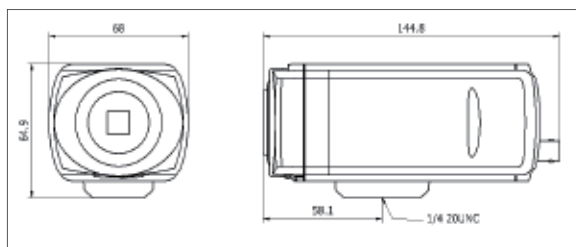

## Accessories



## Specifications

DS-2CC176P-A(-C)	
<b>Camera</b>	
Image sensor	1/2" Sony EXVIEW HAD CCD
Signal system	PAL
Effective pixels	752 (H) × 582 (V)
Min. illumination	Color: 0.003 lux@F1.2, AGC on, 0.00002 lux@F1.2, AGC on, sens-up × 256 B/W: 0.0003 lux@F1.2, AGC on, 0.000002 lux@F1.2, AGC on, sens-up × 256
Shutter time	1/50s ~ 1/100,000s
Lens mount	C/CS mount
Auto iris	DC/Video drive
Day & night	IR cut filter with auto switch
Horizontal resolution	Color: 540 TVL, B/W: 600 TVL
Synchronization	Internal / Power synchronization
Video output	1Vp-p composite output (75 Ω / BNC)
S/N ratio	More than 50dB
<b>Menu</b>	
Camera ID	On / off (15 letters, adjusted position)
Auto gain control	Low / middle / high / off
D/N mode	Auto1 / auto2 / day / night
Auto white balance	Auto trace WB1 / auto trace WB2 / manual / auto Control
Private mask	On / off, maximum 8 zones
Motion detection	Mode 1 / mode 2 / off
Anti-flicker	On / off
RS-485	Address / protocol / baud Rate
Language	English / Chinese
Video	Gamma correction, digital zoom, digital noise reduction, POS/NEG, mirror, resolution, sharpness, Y, C, blemish detection
<b>General</b>	
Operating conditions	-10°C ~ 60°C (14°F ~ 140°F) Humidity 90% or less (non-condensing)
Power supply	24 VAC ± 10%, 12 VDC ± 10% (-C series support 100 - 240 VAC)
Power consumption	5W (10W max. with IR cut filter on)
Dimensions	68 × 64.9 × 144.8 mm (2.68" × 2.56" × 5.70")
Weight	500g (1.10 lbs)

## Available models

DS-2CC176P-A, DS-2CC176P-C

# DS-2CC102P(N)(-A) Mini Box Camera



## Key Features

- 1/3" Sony CCD
- 420 TVL resolution
- Low illumination
- Compact design
- Day / night auto switch

## Specifications

DS-2CC102P(N)(-A)	
<b>Camera</b>	
Image sensor	1/3" Sony CCD
Signal system	PAL / NTSC
Effective pixels	PAL: 500 (H) × 582 (V) NTSC: 510 (H) × 492 (V)
Min. illumination	0.1 lux@F1.2, AGC on
Shutter time	PAL: 1/50s ~ 1/100,000s NTSC: 1/60s ~ 1/100,000s
Lens mount	C/CS mount
Auto iris	DC/Video drive
Day & night	Electronic
Horizontal resolution	420 TVL
Synchronization	Internal synchronization
Video output	1Vp-p composite output(75 Ω / BNC)
S/N ratio	More than 48dB
BLC	On / Off
<b>General</b>	
Operating conditions	-10°C ~ 60°C (14°F ~ 140°F) Humidity 90% or less (non-condensing)
Power supply	12 VDC ± 10% (-A series support 12 VDC ± 10%, 24 VAC ± 10%)
Power consumption	2W max. (-A series 3.5W max.)
Dimensions	63 × 67 × 125.3 mm (2.48" × 2.64" × 4.93")
Weight	550g (1.21 lbs)

## Available models

DS-2CC102P , DS-2CC102P-A, DS-2CC102N, DS-2CC102N-A

## Dimensions

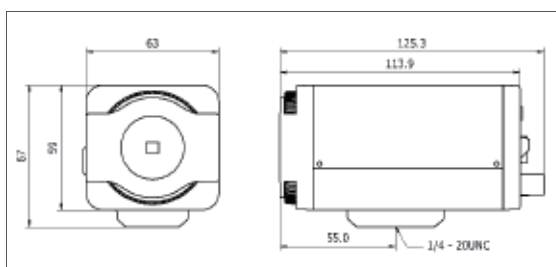

## Accessories



DS-1212ZJ-S (Indoor wall mount) DS-1213ZJ (Indoor/Outdoor Wall Mount) DS-1311/2/3HZ (Indoor/Outdoor camera housing) DS-1320HZ (Indoor camera housing)



# DS-2CC5191P(N)-VF Vari-focal Dome Camera

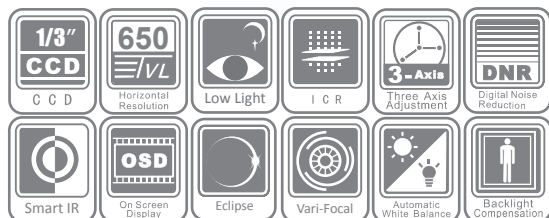

## Key Features

- 1/3" Sony EXVIEW HAD CCD II
- 650 TVL high resolution
- Super low illumination
- True day / night
- Smart IR
- 3-axis adjustment

## Dimensions

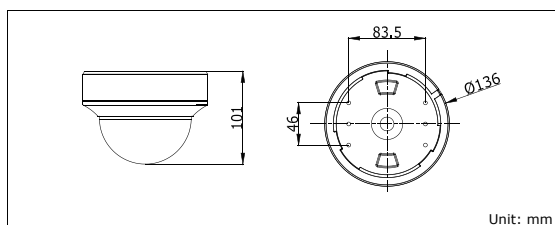

## Specifications

DS-2CC5191P(N)-VF	
<b>Camera</b>	
Image sensor	1/3" Sony EXVIEW HAD CCD II
Signal system	PAL / NTSC
Effective pixels	PAL: 976 (H) × 582 (V) NTSC: 976 (H) × 494 (V)
Min. illumination	Color: 0.001 lux@F1.2, AGC on, B/W: 0.0001 lux@F1.2, AGC on Color: 0.0014 lux@F1.4, AGC on, B/W: 0.00014 lux@F1.4, AGC on
Shutter time	PAL: 1/50s ~ 1/100,000s NTSC: 1/60s ~ 1/100,000s
Lens	2.8 ~ 12 mm @F1.4 Angle of view: 92° ~ 27.2°
Lens mount	Φ 14
Auto iris	DC drive
Angle adjustment	Pan: 0 ~ 355°, tilt: 0 ~ 180°, rotation: 0 ~ 355°
Day & night	IR cut filter with auto switch
Horizontal resolution	Color: 650 TVL, B/W: 700 TVL
Synchronization	Internal / Power synchronization
Video output	1Vp-p composite output (75 Ω / BNC) Test monitor out [1Vp-p composite output (75 Ω / BNC), device line]
S/N ratio	More than 62dB
<b>Menu</b>	
Camera ID	On / off (16 letters, adjusted position)
Auto gain control	Low / middle / high / off
D/N mode	Auto / day / night
White balance	Auto trace WB1 / auto trace WB2 / manual / auto Control
Private mask	On / off, maximum 8 zones
Motion detection	On / off
BLC	Area / value / off
Language	English / Chinese
Video	SMART IR, digital WDR, excessive highlight compensation, digital noise reduction, sharpness, brightness, saturation, resolution, mirror, defect pixel correction
<b>General</b>	
Operating conditions	-10°C ~ 60°C (14°F ~ 140°F) Humidity 90% or less (non-condensing)
Power supply	24 VAC ± 10%, 12 VDC ± 10%
Power consumption	4W max. (4.5W max. with IR cut filter on)
Dimensions	Φ 136 × 101 mm (Φ 5.35" × 3.98")
Weight	800g (1.76 lbs)

## Available models

DS-2CC5191P-VF, DS-2CC5191N-VF

# DS-2CC5193P-VF Vari-focal Dome Camera

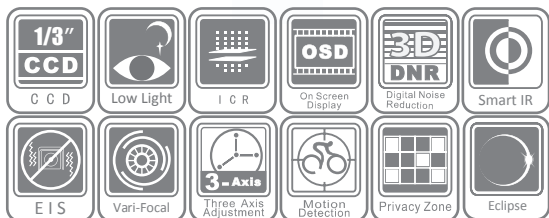

## Key Features

- High performance Sony CCD
- Low illumination
- OSD menu
- True day / night
- 3D digital noise reduction
- 3-axis adjustment

## Dimensions

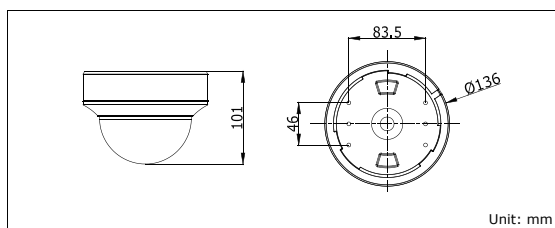

## Specifications

DS-2CC5193P-VF	
<b>Camera</b>	
Image sensor	1/3" Sony EXVIEW HAD CCD II
Signal system	PAL
Effective pixels	976 (H) × 582 (V)
Min. illumination	Color: 0.01 lux@F1.2, AGC on, 0.0001 lux@F1.2, AGC on, sens-up × 512 B/W: 0.001 lux@F1.2, AGC on, 0.00001 lux@F1.2, AGC on, sens-up × 512 Color: 0.014 lux@F1.4, AGC on, 0.00014 lux@F1.4, AGC on, sens-up × 512 B/W: 0.0014 lux@F1.4, AGC on, 0.000014 lux@F1.4, AGC on, sens-up × 512
Shutter time	1/50s ~ 1/100,000s
Lens	2.8 ~ 12 mm @F1.4 Angle of view: 92° ~ 27.2°
Lens mount	Φ 14
Auto iris	DC drive
Angle adjustment	Pan: 0 ~ 355°, tilt: 0 ~ 180°, rotation: 0 ~ 355°
Day & night	IR cut filter with auto switch
Horizontal resolution	Color: 650 TVL, B/W: 700 TVL
Synchronization	Internal / Power synchronization
Video output	1Vp-p composite output (75 Ω / BNC) Test monitor out [1Vp-p composite output (75 Ω / BNC), device line]
S/N ratio	More than 62dB
<b>Menu</b>	
Camera ID	On / off (16 letters, adjusted position)
Auto gain control	Low / middle / high / off
D/N mode	Auto / day / night
White balance	Auto trace WB1 / auto trace WB2 / manual / auto control
Private mask	On / off, maximum 12 zones
Motion detection	On / off
BLC	Area / value / off
Anti-flicker	On / off
Language	English / Chinese
Video	SMART IR, digital WDR, excessive highlight compensation, digital noise reduction, sharpness, brightness, saturation, resolution, electronic image stabilization, digital zoom, mirror, blemish detection
Scene	Indoor standard, indoor backlight, outdoor, low illumination, IR standard, customize
<b>General</b>	
Operating conditions	-10°C ~ 60°C (14°F ~ 140°F) Humidity 90% or less (non-condensing)
Power supply	24 VAC ± 10%, 12 VDC ± 10%
Power consumption	4W max. (4.5W max. with IR cut filter on)
Dimensions	Φ 136 × 101 mm (Φ 5.35" × 3.98")
Weight	800g (1.76 lbs)

## Available models

DS-2CC5193P-VF

# DS-2CC5195P(N)-VF Low Light Dome Camera

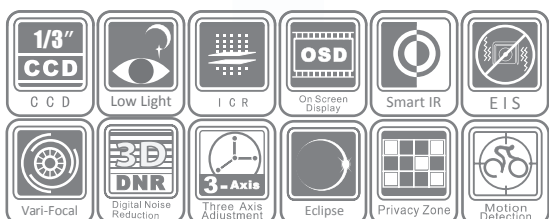

## Key Features

- High performance Sony CCD
- Super low illumination
- OSD menu
- True day / night
- 3D digital noise reduction
- 3-axis adjustment

## Dimensions

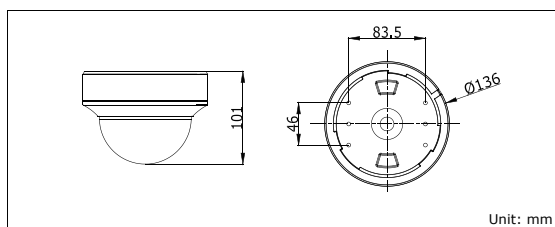

## Specifications

DS-2CC5195P(N)-VF	
<b>Camera</b>	
Image sensor	1/3" Sony EXVIEW HAD CCD II
Signal system	PAL / NTSC
Effective pixels	PAL: 976 (H) × 582 (V) NTSC: 976 (H) × 494 (V)
Min. illumination	Color: 0.001 lux@F1.2, AGC on, 0.0001 lux@F1.2, AGC on, sens-up × 512 B/W: 0.0001 lux@F1.2, AGC on, 0.00001 lux@F1.2, AGC on, sens-up × 512 Color: 0.0014 lux@F1.4, AGC on, 0.00014 lux@F1.4, AGC on, sens-up × 512 B/W: 0.00014 lux@F1.4, AGC on, 0.000014 lux@F1.4, AGC on, sens-up × 512
Shutter time	PAL: 1/50s ~ 1/100,000s NTSC: 1/60s ~ 1/100,000s
Lens	2.8 ~ 12mm @F1.4 Angle of view: 92° ~ 27.2°
Lens mount	Φ 14
Auto iris	DC drive
Angle adjustment	Pan: 0 ~ 355°, tilt: 0 ~ 180°, rotation: 0 ~ 355°
Day & night	IR cut filter with auto switch
Horizontal resolution	Color: 650 TVL, B/W: 700 TVL
Synchronization	Internal / Power synchronization
Video output	1Vp-p composite output (75 Ω / BNC) Test monitor out [1Vp-p composite output (75 Ω / BNC), device line]
S/N ratio	More than 62dB
<b>Menu</b>	
Camera ID	On / off (16 letters, adjusted position)
Auto gain control	Low / middle / high / off
D/N mode	Auto / day / night
White balance	Auto trace WB1 / auto trace WB2 / manual / auto control
Private mask	On / off, maximum 12 zones
Motion detection	On / off
BLC	Area / value / off
Anti-flicker	On / off
Language	English / Chinese
Video	SMART IR, digital WDR, excessive highlight compensation, digital noise reduction, sharpness, brightness, saturation, resolution, electronic image stabilization, digital zoom, mirror, blemish detection
Scene	Indoor standard, indoor backlight, outdoor, low illumination, IR standard, customize
<b>General</b>	
Operating conditions	-10°C ~ 60°C (14°F ~ 140°F) Humidity 90% or less (non-condensing)
Power supply	24 VAC ± 10%, 12 VDC ± 10%
Power consumption	4W max. (4.5W max. with IR cut filter on)
Dimensions	Φ 136 × 101 mm (Φ 5.35" × 3.98")
Weight	800g (1.76 lbs)

## Available models

DS-2CC5195P-VF, DS-2CC5195N-VF

# DS-2CC5197P-VF WDR Dome Camera

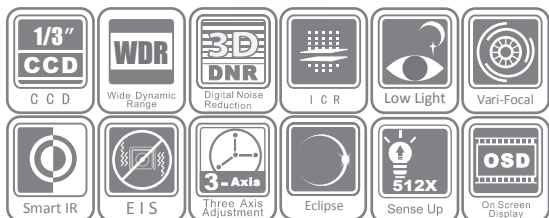

## Key Features

- High performance Sony CCD
- 75dB wide dynamic range
- Super low illumination
- True day / night
- 3D digital noise reduction
- 3-axis adjustment

## Dimensions

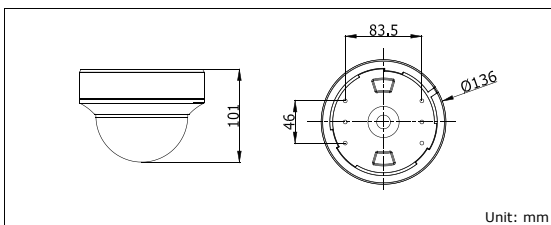

## Specifications

DS-2CC5197P-VF	
<b>Camera</b>	
Image sensor	1/3" Sony Super HAD CCD II
Signal system	PAL
Effective pixels	976 (H) × 582 (V)
Min. illumination	Color: 0.001 lux@F1.2, AGC on, 0.0001 lux@F1.2, AGC on, sens-up × 512 B/W: 0.0001 lux@F1.2, AGC on, 0.00001 lux@F1.2, AGC on, sens-up × 512 Color: 0.0014 lux@F1.4, AGC on, 0.00014 lux@F1.4, AGC on, sens-up × 512 B/W: 0.00014 lux@F1.4, AGC on, 0.000014 lux@F1.4, AGC on, sens-up × 512
Shutter time	1/50s ~ 1/100,000s
Lens	2.8 ~ 12 mm @F1.4 Angle of view: 92° ~ 27.2°
Lens mount	Φ14
Auto iris	DC drive
Angle adjustment	Pan: 0 ~ 355°, tilt: 0 ~ 180°, rotation: 0 ~ 355°
Day & night	IR cut filter with auto switch
Horizontal resolution	Color: 650 TVL, B/W: 700 TVL
Wide dynamic range	75 dB
Synchronization	Internal / Power synchronization
Video output	1Vp-p composite output (75 Ω / BNC) Test monitor out [1Vp-p composite output (75 Ω / BNC), device line
S/N ratio	More than 62dB
<b>Menu</b>	
Camera ID	On / off (16 letters, adjusted position)
Auto gain control	Low / middle / high / off
D/N mode	Auto / day / night
White balance	Auto trace WB1 / auto trace WB2 / manual / auto Control
Private mask	On / off, maximum 12 zones
Motion detection	On / off
BLC	Area / value / off
WDR	Value / contrast / return
Anti-flicker	On / off
Language	English / Chinese
Video	SMART IR, excessive highlight compensation, digital noise reduction, sharpness, brightness, saturation, resolution, electronic image stabilization, digital zoom, mirror, blemish detection
Scene	Indoor standard, indoor backlight, outdoor, low illumination, customize
<b>General</b>	
Operating conditions	-10°C ~ 60°C (14°F ~ 140°F) Humidity 90% or less (non-condensing)
Power supply	24 VAC ± 10%, 12 VDC ± 10%
Power consumption	4W max. (4.5W max. with IR cut filter on)
Dimensions	Φ 136 × 101 mm (Φ 5.35" × 3.98")
Weight	800g (1.76 lbs)

## Available models

DS-2CC5197P-VF

# DS-2CC5132P(N) DIS Dome Camera

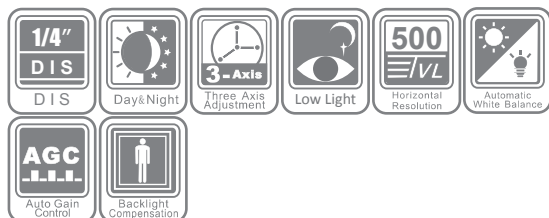

## Key Features

- 1/4" DIS
- 500 TVL resolution
- Low illumination
- Day / night auto switch
- 3-axis adjustment
- Compact design

## Specifications

DS-2CC5132P(N)	
<b>Camera</b>	
Image sensor	1/4" DIS
Signal system	PAL / NTSC
Effective pixels	640 (H) × 480 (V)
Min. illumination	0.1 lux@F1.2, AGC on 0.28 lux@F2.0, AGC on
Shutter time	PAL: 1/25s ~ 1/15,000s NTSC: 1/30s ~ 1/15,000s
Lens	2.8mm @F1.8 (3.6mm, 6mm, 8mm, 16mm optional) Angle of view: 66 (2.8mm)
Lens mount	M12
Angle adjustment	Pan: 0 ~ 355°, tilt: 0 ~ 90°, rotation: 0 ~ 355°
Day & night	Electronic
Horizontal Resolution	500 TVL
Synchronization	Internal synchronization
Video output	1Vp-p composite output (75 Ω / BNC)
S/N ratio	More than 52dB
<b>General</b>	
Operating conditions	-40°C ~ 70°C (-40°F ~ 158°F) Humidity 90% or less (non-condensing)
Power supply	12 VDC ± 10%
Power consumption	1W max.
Dimensions	Φ 97.8 x 64.4 mm (Φ 3.85" x 2.54")
Weight	300g (0.66 lbs)

## Dimensions

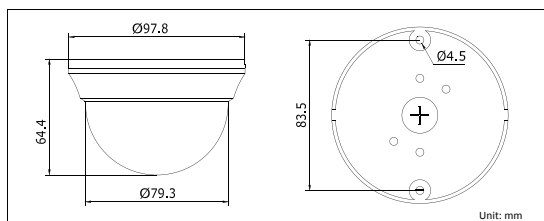

## Available models

DS-2CC5132P, DS-2CC5132N

# DS-2CC5112/5172P Dome Camera

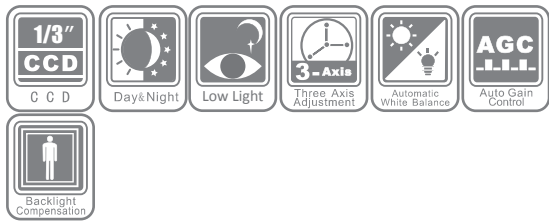

## Key Features

- High performance Sony CCD
- Low illumination
- Day / night auto switch
- 3-axis adjustment
- Compact design

## Dimensions

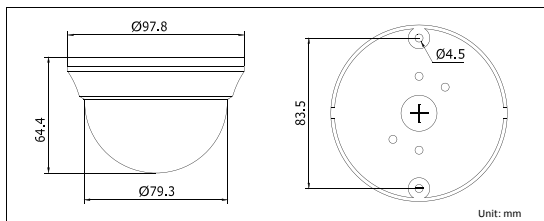

## Specifications

	DS-2CC5112P	DS-2CC5172P
<b>Camera</b>		
Image sensor	1/3" Sony Super HAD CCD II	
Signal system	PAL	
Effective pixels	752 (H) × 582 (V)	
Min. illumination	0.1 lux@F1.2, AGC on 0.28 lux@F2.0, AGC on	
Shutter time	1/50s ~ 1/100,000s	
Lens	3.6mm @F2.0 (2.8mm, 6mm, 8mm, 12mm, 16mm optional) Angle of view: 78° (3.6mm)	
Lens mount	M12	
Angle adjustment	Pan: 0 ~ 355°, tilt: 0 ~ 90°, rotation: 0 ~ 355°	
Day & night	Electronic	
Horizontal resolution	480 TVL	540 TVL
Synchronization	Internal synchronization	
Video output	1Vp-p composite output (75 Ω / BNC); Test monitor out [1Vp-p composite output (75 Ω / BNC), device line]	
S/N ratio	More than 52dB	
<b>General</b>		
Operating conditions	-10°C ~ 60°C (14°F ~ 140°F) Humidity 90% or less (non-condensing)	
Power supply	12 VDC ± 10%	
Power consumption	2W max.	
Dimensions	Φ 97.8 x 64.4mm (Φ 3.85" x 2.54")	
Weight	300g (0.66 lbs)	

## Available models

DS-2CC5112P, DS-2CC5172P

# DS-2CC5192P(N) Low Light Dome Camera

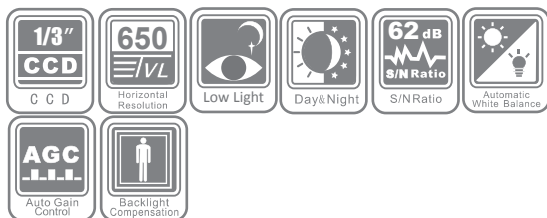

## Key Features

- 1/3" Sony EXVIEW HAD CCD II
- 650 TVL high resolution
- Super low illumination
- Day / night auto switch
- 3-axis adjustment
- Compact design

## Dimensions

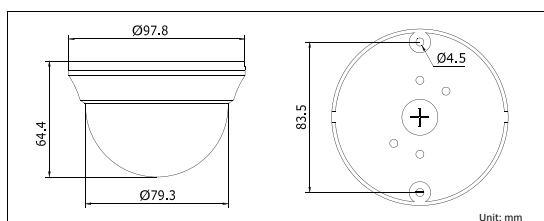

## Specifications

DS-2CC5192P(N)	
<b>Camera</b>	
Image sensor	1/3" Sony EXVIEW HAD CCD II
Signal system	PAL / NTSC
Effective pixels	PAL: 976 (H) × 582 (V) NTSC: 976 (H) × 494 (V)
Min. illumination	0.001 lux@F1.2, AGC on 0.0028 lux@F2.0, AGC on
Shutter time	PAL: 1/50s ~ 1/100,000s NTSC: 1/60s ~ 1/100,000s
Lens	3.6mm @F2.0 (2.8mm, 6mm, 8mm, 12mm, 16mm optional) Angle of view: 78° (3.6mm)
Lens mount	M12
Angle adjustment	Pan: 0 ~ 355°, tilt: 0 ~ 90°, rotation: 0 ~ 355°
Day & night	Electronic
Horizontal resolution	650 TVL
Synchronization	Internal synchronization
Video output	1Vp-p composite output (75 Ω / BNC); Test monitor out [1Vp-p composite output (75 Ω / BNC), device line]
S/N ratio	More than 62 dB
<b>General</b>	
Operating conditions	-10°C ~ 60°C (14°F ~ 140°F) Humidity 90% or less (non-condensing)
Power supply	12 VDC ± 10%
Power consumption	2W max.
Dimensions	Φ 97.8 x 64.4 mm (Φ 3.85" x 2.54")
Weight	300g (0.66 lbs)

## Available models

DS-2CC5192P, DS-2CC5192N

# DS-2CC5102P(N) Dome Camera

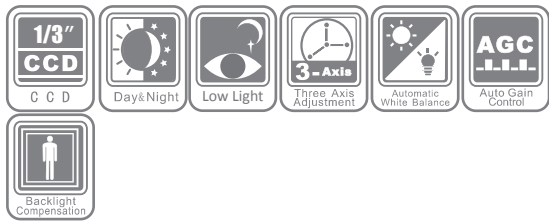

## Key Features

- High performance Sony CCD
- Low illumination
- Day / night auto switch
- 3-axis adjustment
- Compact design

## Dimensions

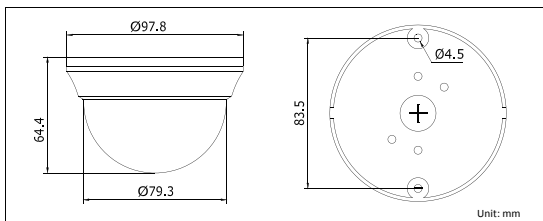

## Specifications

DS-2CC5102P(N)	
<b>Camera</b>	
Image sensor	1/3" Sony Super HAD CCD II
Signal system	PAL / NTSC
Effective pixels	PAL: 500 (H) × 582 (V) NTSC: 510 (H) × 492 (V)
Min. illumination	0.1 lux@F1.2, AGC on 0.28 lux@F2.0, AGC on
Shutter time	1/50s ~ 1/100,000s
Lens	3.6mm @F2.0 (2.8mm, 6mm, 8mm, 12mm, 16mm optional) Angle of view: 78° (3.6mm)
Lens mount	M12
Angle adjustment	Pan: 0 ~ 355°, tilt: 0 ~ 90°, rotation: 0 ~ 355°
Day & night	Electronic
Horizontal resolution	420 TVL
Synchronization	Internal synchronization
Video output	1Vp-p composite output (75 Ω / BNC); Test monitor out [1Vp-p composite output (75 Ω / BNC), device line]
S/N ratio	More than 50dB
<b>General</b>	
Operating conditions	-10°C ~ 60°C (14°F ~ 140°F) Humidity 90% or less (non-condensing)
Power supply	12 VDC ± 10%
Power consumption	2W max.
Dimensions	Φ 97.8 x 64.4 mm (φ 3.85" x 2.54")
Weight	300g (0.66 lbs)

## Available models

DS-2CC5102P, DS-2CC5102N



# DS-2CC5173P(N)-VP(IR)(H) Vandal-proof Dome Camera

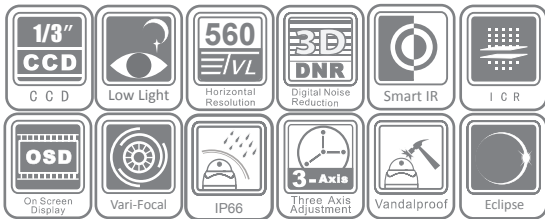

## Key Features

- 1/3" Sony Super HAD CCD II
- 560 TVL resolution
- Low illumination
- True day / night
- 3-axis adjustment
- IP66 rating

## Dimension

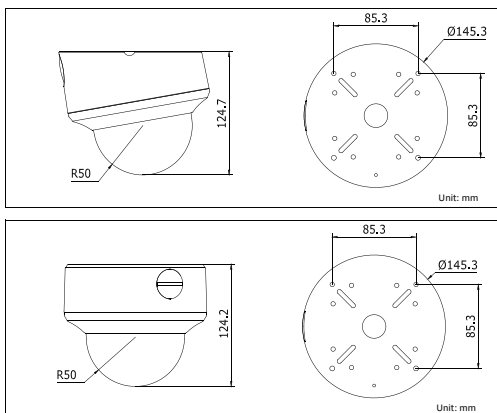

## Accessorie



## Specifications

DS-2CC5173P(N)-VP(IR)(H)	
<b>Camera</b>	
Image sensor	1/3" Sony Super HAD CCD II
Signal system	PAL / NTSC
Effective pixels	PAL: 752 (H) × 582 (V) NTSC: 768 (H) × 494 (V)
Min. illumination	Color: 0.1 lux@F1.2, AGC on, 0.0003 lux@F1.2, AGC on, sens-up × 256 Color: 0.14 lux@F1.4, AGC on, 0.0004 lux@F1.4, AGC on, sens-up × 256 B/W: 0.01 lux@F1.2, AGC on, 0.00003 lux@F1.2, AGC on, sens-up × 256 B/W: 0.014 lux@F1.4, AGC on, 0.00004 lux@F1.4, AGC on, sens-up × 256 -IR: 0.1 lux@F1.2, AGC on, 0.0003 lux@F1.2, AGC on, sens-up × 256, 0 lux with IR 0.14 lux@F1.4, AGC on, 0.0004 lux@F1.4, AGC on, sens-up × 256, 0 lux with IR
Shutter time	PAL: 1/50s ~ 1/100,000s NTSC: 1/60s ~ 1/100,000s
Lens	2.8 ~ 12 mm @F1.4, Angle of view: 92° ~ 27.2°
Lens mount	Φ14
Auto iris	DC drive
Angle adjustment	Pan: 0 ~ 355°, tilt: 0 ~ 80°, rotation: ± 90°
Day & night	IR cut filter with auto switch
Horizontal resolution	Color: 560 TVL, B/W: 600 TVL
Synchronization	Internal / power synchronization
Video output	1Vp-p composite output (75 Ω / BNC); Test monitor out [1Vp-p composite output (75 Ω / BNC), device line]
S/N ratio	More than 52 dB
<b>Menu</b>	
Camera ID	On / off (15 letters, adjusted position)
Auto gain control	Low / middle / high / off
D/N mode	Auto / day / night
White balance	Auto trace WB1 / auto trace WB2 / manual / auto control
Privacy mask	On / off, maximum 8 zones
Motion detection	On / off
BLC	Area / value / off
HLS	On / off
Digital WDR	Indoor / outdoor / off
Anti-flicker	On / off
Language	English / Chinese
Video	SMART IR, digital WDR, excessive highlight compensation, gamma correction, digital zoom, digital noise reduction, POS / NEG, mirror, sharpness, Y, C, blemish detection
<b>General</b>	
Operating conditions	-10°C ~ 60°C (14°F ~ 140°F) Humidity 90% or less (non-condensing) -H: -40°C ~ 60°C (-40°F ~ 140°F) with heater and fan on
Power supply	24 VAC ± 10%, 12 VDC ± 10% -H: 24 VAC ± 10%
Weather-proof rating	IP66
Heater	-H: support
IR range	-IR: approx. 20 ~ 30m
Power consumption	4W max. -IR: 12W max. -H: 16W max. -IRH: 24W max.
Impact protection	IEC60068-2-75 test, Eh, 50J; EN50102, up to IK10.
Dimensions	Φ 145.3 × 124.2 mm (Φ 5.72" × 4.89")
Weight	2000g (4.40 lbs)

## Available models

DS-2CC5173P-VP, DS-2CC5173P-VPIR, DS-2CC5173P-VPH, DS-2CC5173P-VPIRH  
DS-2CC5173N-VP, DS-2CC5173N-VPIR, DS-2CC5173N-VPH, DS-2CC5173N-VPIRH

# DS-2CC5193P-VP(IR)(H) Vandal-proof Dome Camera

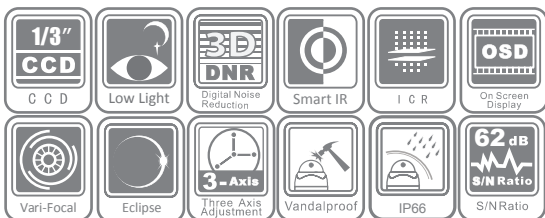

## Key Features

- 1/3" Sony EXVIEW HAD CCD II
- Low illumination
- True day / night
- 3-axis adjustment
- 3D digital noise reduction
- IP66 rating

## Dimensions

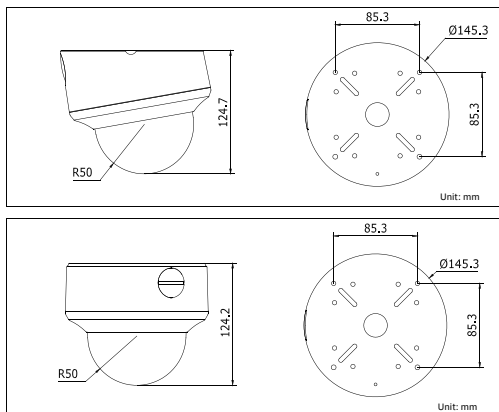

## Accessories



## Specifications

DS-2CC5193P(N)-VP(IR)(H)	
<b>Camera</b>	
Image sensor	1/3" Sony EXVIEW HAD CCD II
Signal system	PAL / NTSC
Effective pixels	PAL: 976 (H) × 582 (V), NTSC: 976 (H) × 494 (V)
Min. illumination	Color: 0.01 lux@F1.2, AGC on, 0.0001 lux@F1.2, AGC on, sens-up × 512 Color: 0.014 lux@F1.4, AGC on, 0.00014 lux@F1.4, AGC on, sens-up × 512 B/W: 0.001 lux@F1.2, AGC on, 0.00001 lux@F1.2, AGC on, sens-up × 512 B/W: 0.0014 lux@F1.4, AGC on, 0.000014 lux@F1.4, AGC on, sens-up × 512 -IR: 0.01 lux@F1.2, AGC on, 0.0001 lux@F1.2, AGC on, sens-up × 512, 0 lux with IR 0.014 lux@F1.4, AGC on, 0.00014 lux@F1.4, AGC on, sens-up × 512, 0 lux with IR
Shutter time	PAL: 1/50s ~ 1/100,000s, NTSC: 1/60s ~ 1/100,000s
Lens	2.8 ~ 12mm @F1.4, Angle of view: 92° ~ 27.2°
Lens mount	Φ 14
Auto iris	DC drive
Angle adjustment	Pan: 0 ~ 355°, tilt: 0 ~ 80°, rotation: ± 90°
Day & night	IR cut filter with auto switch
Horizontal resolution	Color: 650 TVL, B/W: 700 TVL
Synchronization	Internal / power synchronization
Video output	1Vp-p composite output (75 Ω / BNC); Test monitor out [1Vp-p composite output (75 Ω / BNC), device line]
S/N ratio	More than 62dB
<b>Menu</b>	
Camera ID	On / off (16 letters, adjusted position)
Auto gain control	Low / middle / high / off
D/N mode	Auto 1 / auto 2 / day / night
White balance	Auto trace WB1 / auto trace WB2 / manual / auto control
Privacy mask	On / off, maximum 12 zones
Motion detection	On / off
BLC	Area / value / off
HLS	On / off
Digital WDR	On / off
Anti-flicker	On / off
Language	English / Chinese
Video	SMART IR, digital WDR, excessive highlight compensation, gamma correction, digital zoom, digital noise reduction, POS / NEG, mirror, sharpness, Y, C, blemish detection
Scene	Indoor standard, Indoor backlight, outdoor, low illumination, IR standard, customize
<b>General</b>	
Operating conditions	-10°C ~ 60°C (14°F ~ 140°F), Humidity 90% or less (non-condensing) -H: -40°C ~ 60°C (-40°F ~ 140°F) with heater and fan on
Power supply	24 VAC ± 10%, 12 VDC ± 10% (-H: 24 VAC ± 10%)
Weather-proof rating	IP66
Heater	-H: support
IR range	-IR: approx. 20 ~ 30m
Power consumption	5W max. -IR: 13W max. -H: 17W max. -IRH: 25W max.
Impact protection	IEC60068-2-75 test, Eh, 50J; EN50102, up to IK10.
Dimensions	Φ 145.3 × 124.2 mm (Φ 5.72" × 4.89")
Weight	2000g (4.40 lbs)

## Available models

DS-2CC5193P-VP, DS-2CC5193P-VPIR, DS-2CC5193P-VP(H), DS-2CC5193P-VPIRH  
DS-2CC5193N-VP, DS-2CC5193N-VPIR, DS-2CC5193N-VP(H), DS-2CC5193N-VPIRH

# DS-2CC502/512/592P(N)-FB

# Vandal-proof Dome Camera



### Key Features

- Compact design
- 1/3" Sony CCD
- Day / night auto swith
- Low illumination
- Auto white balance,auto gain control,electronic shutter control and backlight compensation
- Internal synchronization

### Dimensions

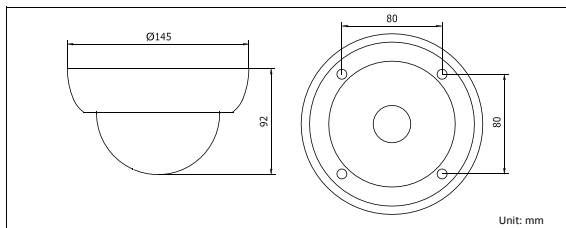

### Specifications

	DS-2CC502P(N)-FB	DS-2CC512P(N)-FB	DS-2CC592P(N)-FB
<b>Camera</b>			
Image sensor	1/3" Sony CCD		
Signal system	PAL / NTSC		
Effective pixels	PAL: 500 (H) × 582 (V) NTSC: 510 (H) × 492 (V)	PAL: 752 (H) × 582 (V) NTSC: 768 (H) × 494 (V)	PAL: 752 (H) × 582 (V) NTSC: 768 (H) × 494 (V)
Min. illumination	0.1 lux@F1.2, AGC on 0.18 lux@F1.6, AGC on		
Shutter time	PAL: 1/50s ~ 1/100,000s NTSC: 1/60s ~ 1/100,000s		
Lens	4 ~ 9 mm @F1.6 Angle of view: 74.6° ~ 32°		
Lens mount	Φ 14		
Angle adjustment	Pan: 0 ~ 355°; tilt: 0 ~ 90°;		
Day & night	Electronic		
Horizontal resolution	420 TVL	480 TVL	540 TVL
Synchronization	Internal synchronization		
Video output	1Vp-p composite output (75 Ω / BNC)		
S/N ratio	More than 48dB		
BLC	On		
<b>General</b>			
Operating conditions	-10°C ~ 60°C (14°F ~ 140°F) Humidity 90% or less (non-condensing)		
Power supply	12 VDC ± 10%		
Power consumption	2W max.		
Impact protection	IEC 60068-2-75 test, Eh, 50J; EN 50102, up to IK10.		
Dimensions	Φ 145 × 92 mm (Φ 5.71" × 3.62")		
Weight	660g (1.46 lbs)		

### Available models

DS-2CC502P-FB, DS-2CC502N-FB, DS-2CC512P-FB, DS-2CC512N-FB, DS-2CC592P-FB, DS-2CC592N-FB

# DS-2CC511/591P(N)-A Vari-focal Dome Camera

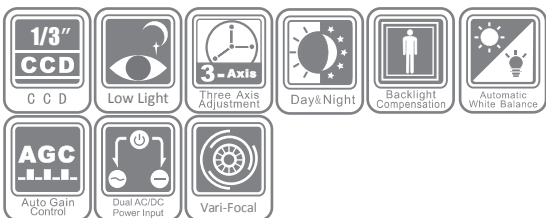

## Key Features

- Compact design
- 1/3" Sony CCD
- Low Illumination
- Day / night with auto switch
- Auto white balance, auto gain control, electronic shutter control and backlight compensation

## Dimensions

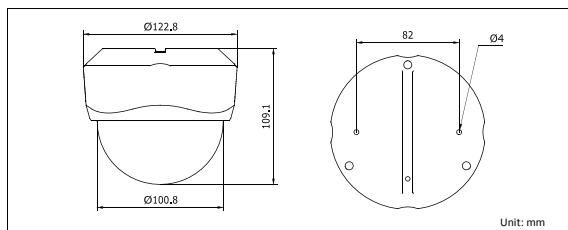

## Specifications

	DS-2CC511P(N)-A	DS-2CC591P(N)-A
<b>Camera</b>		
Image sensor	1/3" Sony CCD	
Signal system	PAL / NTSC	
Effective pixels	PAL: 752 (H) × 582 (V) NTSC: 768 (H) × 494 (V)	
Min. illumination	0.1 lux@F1.2, AGC on	
Shutter time	PAL: 1/50s ~ 1/100,000s NTSC: 1/60s ~ 1/100,000s	
Lens	3.5 ~ 9mm @F1.2 (2.8 ~ 11mm optional) Angle of view: 80° ~ 30° (3.5 ~ 9mm)	
Lens mount	Φ 14	
Auto iris	DC Drive	
Angle adjustment	Pan: 0 ~ 355°; tilt: 0 ~ 80°; rotation: 0 ~ 140°	
Day & night	Electronic	
Horizontal resolution	480 TVL	540 TVL
Synchronization	Internal synchronization	
Video output	1Vp-p composite output (75 Ω / BNC)	
S/N ratio	More than 48dB	
BLC	On / off	
<b>General</b>		
Operating conditions	-10°C ~ 60°C (14°F ~ 140°F) Humidity 90% or less (non-condensing)	
Power supply	24 VAC ± 10%, 12 VDC ± 10%	
Power consumption	3.5W max.	
Dimensions	Φ 122.8 × 109.1 mm (Φ 4.83" × 4.30")	
Weight	400g (0.88 lbs)	

## Available models

DS-2CC511P-A, DS-2CC511N-A, DS-2CC591P-A, DS-2CC591N-A

# DS-2CC102/112/192P(N)-IR IR Bullet Camera



## Key Features

- Compact design
- 1/3" Sony CCD
- Low illumination
- Auto white balance, auto gain control, electronic shutter control and backlight compensation
- Internal synchronization
- IP66 rating

## Dimensions

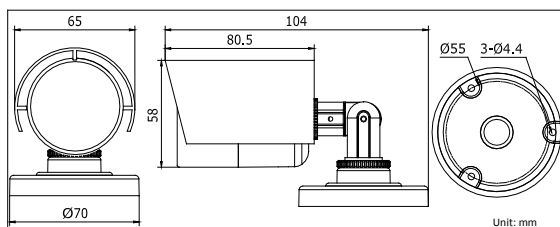

## Specifications

	DS-2CC102P(N)-IR	DS-2CC112P(N)-IR	DS-2CC192P(N)-IR
<b>Camera</b>			
Image sensor	1/3" Sony CCD		
Signal system	PAL / NTSC		
Effective pixels	PAL: 500 (H) × 582 (V) NTSC: 510 (H) × 492 (V)	PAL: 752 (H) × 582 (V) NTSC: 768 (H) × 494 (V)	PAL: 752 (H) × 582 (V) NTSC: 768 (H) × 494 (V)
Min. illumination	0.1 lux@F1.2, AGC on, 0 lux with IR 0.2 lux@F1.8, AGC on, 0 lux with IR		
Shutter time	PAL: 1/50s ~ 1/100,000s NTSC: 1/60s ~ 1/100,000s		
Lens	6 mm @F1.8 (3.6mm, 2.8mm optional) Angle of view: 47° (6mm)		
Lens mount	M12		
Day & night	Electronic		
Horizontal resolution	420 TVL	480 TVL	540 TVL
Synchronization	Internal synchronization		
Video output	1Vp-p composite output (75Ω / BNC)		
S/N ratio	More than 48dB		
BLC	On		
<b>General</b>			
Operating conditions	-10 °C ~ 60 °C (14 °F ~ 140 °F) Humidity 90% or less (non-condensing)		
Power supply	12 VDC ± 10%		
Power consumption	3W max.		
Weather-proof rating	IP66		
IR range	Approx. 10 ~ 20m		
Dimensions	Φ 65 × 104mm (Φ 2.56" × 4.09")		
Weight	250g (0.55 lbs)		

## Available models

DS-2CC102P-IR, DS-2CC102N-IR, DS-2CC112P-IR, DS-2CC112N-IR, DS-2CC192P-IR, DS-2CC192N-IR

# DS-2CC102/112/192P(N)-IR3/IR5 IR Bullet Camera



## Key Features

- Compact design
- 1/3" Sony CCD
- Low illumination
- Auto white balance, auto gain control, electronic shutter control and backlight compensation
- Internal synchronization
- IP66 rating

## Dimensions

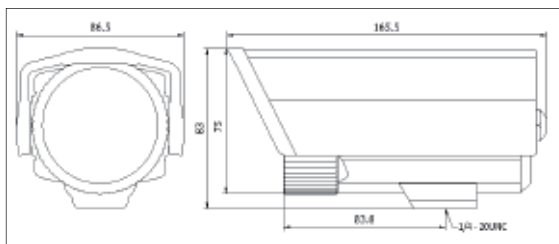

## Accessories



DS-1212ZJ-S  
(Indoor wall mount)



DS-1213ZJ-S  
(Outdoor wall mount)

## Specifications

	DS-2CC102P(N)-IR3(IR5)	DS-2CC112P(N)-IR3(IR5)	DS-2CC192P(N)-IR3(IR5)
<b>Camera</b>			
Image sensor	1/3" Sony CCD		
Signal system	PAL / NTSC		
Effective pixels	PAL: 500 (H) × 582 (V) NTSC: 510 (H) × 492 (V)	PAL: 752 (H) × 582 (V) NTSC: 768 (H) × 494 (V)	PAL: 752 (H) × 582 (V) NTSC: 768 (H) × 494 (V)
Min. illumination	0.1 lux@F1.2, AGC on, 0 lux with IR 0.2 lux@F1.8, AGC on, 0 lux with IR		
Shutter time	PAL: 1/50s ~ 1/100,000s NTSC: 1/60s ~ 1/100,000s		
Lens	"-IR3" series: 12mm @F1.8 (3.6mm, 6mm, 8mm, 16mm optional), Angle of view: 22.72° (12mm) "-IR5" series: 16mm @F1.8 (3.6mm, 6mm, 8mm, 12mm optional), Angle of view: 16.4° (16mm)		
Lens mount	M12		
Day & night	Electronic		
Horizontal resolution	420 TVL	480 TVL	540 TVL
Synchronization	Internal synchronization		
Video output	1Vp-p composite output (75Ω / BNC)		
S/N ratio	More than 48 dB		
BLC	On		
<b>General</b>			
Operating conditions	-10°C ~ 60°C (14°F ~ 140°F) Humidity 90% or less (non-condensing)		
Weather-proof rating	IP66		
IR range	"-IR3" series: approx. 30 ~ 40m "-IR5" series: approx. 50 ~ 60m		
Power supply	12 VDC ± 10%		
Power consumption	IR3: 6W max IR5: 8W max		
Dimensions	Φ 86.5 × 83 × 165.5 mm (Φ 3.41" × 3.27" × 6.52")		
Weight	1000g (2.20 lbs)		

## Available models

DS-2CC102P-IR3, DS-2CC102N-IR3, DS-2CC102P-IR5, DS-2CC102N-IR5, DS-2CC112P-IR3, DS-2CC112N-IR3, DS-2CC112P-IR5, DS-2CC112N-IR5, DS-2CC192P-IR3, DS-2CC192N-IR3, DS-2CC192P-IR5, DS-2CC192N-IR5

# DS-2CC102/112/192P(N)-IRA IR Bullet Camera



## Key Features

- Compact design
- 1/3" Sony CCD
- Low illumination
- Up to 110m IR range
- Auto white balance, auto gain control, electronic shutter control and backlight compensation
- Internal synchronization
- IP66 rating

## Dimensions

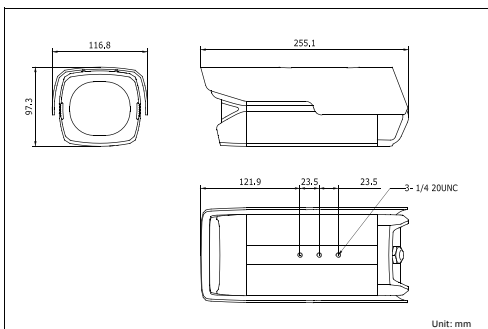

## Accessories



DS-1212ZJ-S  
(Indoor wall mount)

DS-1213ZJ-S  
(Outdoor wall mount)

## Specifications

	DS-2CC102P(N)-IRA	DS-2CC112P(N)-IRA	DS-2CC192P(N)-IRA
<b>Camera</b>			
Image sensor	1/3" Sony CCD		
Signal system	PAL / NTSC		
Effective pixels	PAL: 500 (H) × 582 (V) NTSC: 510 (H) × 492 (V)	PAL: 752 (H) × 582 (V) NTSC: 768 (H) × 494 (V)	PAL: 752 (H) × 582 (V) NTSC: 768 (H) × 494 (V)
Min. illumination	0.1 lux@F1.2, AGC on, 0 lux with IR 0.14 lux@F1.4, AGC on, 0 lux with IR		
Shutter time	PAL: 1/50s ~ 1/100,000s NTSC: 1/60s ~ 1/100,000s		
Lens	25 mm @F1.4 (16mm optional) Angle of view: 13.5° (25mm)		
Lens mount	CS mount		
Day & night	Electronic		
Horizontal resolution	420 TVL	480 TVL	540 TVL
Synchronization	Internal synchronization		
Video output	1Vp-p composite output (75Ω / BNC)		
S/N ratio	More than 48 dB		
BLC	On		
<b>General</b>			
Operating conditions	-10°C ~ 60°C (14°F ~ 140°F) Humidity 90% or less (non-condensing)		
Power supply	24 VAC ± 10% (12 VDC ± 10% optional)		
Power consumption	15W max.		
Weather-proof rating	IP66		
IR range	Approx. 100 ~ 110m		
Dimensions	116.8 × 97.3 × 255.1 mm (4.60" × 3.83" × 10.04")		
Weight	2500g (5.50 lbs)		

## Available models

DS-2CC102P-IRA, DS-2CC102N-IRA, DS-2CC112P-IRA  
DS-2CC112N-IRA, DS-2CC192P-IRA, DS-2CC192N-IRA

# DS-2CC102/112/192P(N)-IRT IR Bullet Camera



## Key Features

- 1/3" Sony CCD
- Vari-focal lens with auto focus. wireless remote with zooming function
- Compact structure design
- Minimum illumination: 0.1lux @ F1.2 (0 lux with IR)

## Dimensions

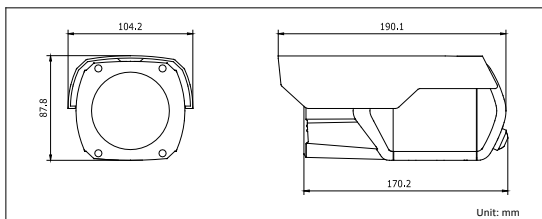

## Accessories



DS-1212ZJ-S  
(Indoor wall mount)



DS-1213ZJ-S  
(Outdoor wall mount)

## Specifications

	DS-2CC102P(N)-IRT	DS-2CC112P(N)-IRT	DS-2CC192P(N)-IRT
<b>Camera</b>			
Image sensor	1/3" Sony CCD		
Signal system	PAL / NTSC		
Effective pixels	PAL: 500 (H) × 582 (V) NTSC: 510 (H) × 492 (V)	PAL: 752 (H) × 582 (V) NTSC: 768 (H) × 494 (V)	PAL: 752 (H) × 582 (V) NTSC: 768 (H) × 494 (V)
Min. Illumination	0.1 lux @ (F1.2, AGC on), 0 lux with IR 0.2 lux @ (F1.8, AGC on), 0 lux with IR		
Shutter Time	PAL: 1/50 s to 1/100,000 s NTSC: 1/60 s to 1/100,000 s		
Lens	4 - 9 mm @ F1.8 (5 ~ 15 mm optional), adjusted by remote control Angle of view: 60° ~ 30° (4 ~ 9 mm)		
Lens Mount	Φ14		
Day & Night	Electronic		
Horizontal Resolution	420 TVL	480 TVL	540 TVL
Synchronization	Internal synchronization		
Video Output	1 Vp-p composite output (75Ω /BNC)		
S/N Ratio	More than 48 dB		
BLC	On		
<b>General</b>			
Operating Conditions	-10 °C ~ 60 °C (14 °F ~ 140 °F) Humidity 90% or less (non-condensing)		
Power Supply	12 VDC ± 10%, 24 VAC ± 10%		
Power Consumption	Max. 1 W		
Weather Proof Rating	IP66		
IR Range	Approx 30 to 40 meters		
Dimensions	104.2 × 87.8 × 190.1 mm (4.10" × 3.46" × 7.48")		
Weight	1000g (2.20 lbs)		

## Available models

DS-2CC102P-IRT, DS-2CC102N-IRT, DS-2CC112P-IRT  
DS-2CC112N-IRT, DS-2CC192P-IRT, DS-2CC192N-IRT



# DS-2CC1132P(N)-IR IR Weather-proof DIS Bullet Camera

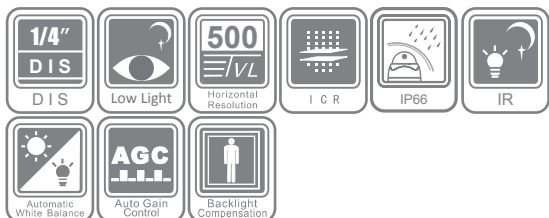

## Key Features

- 1/4" DIS
- 500TVL resolution
- 20m IR range
- Low illumination
- True day / night
- IP66 rating

## Dimensions

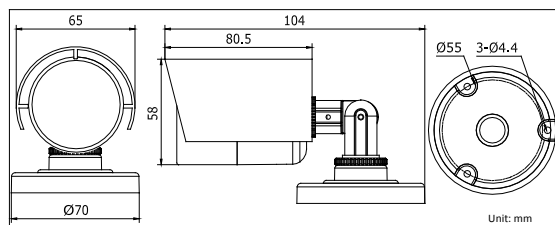

## Specifications

DS-2CC1132P(N)-IR	
<b>Camera</b>	
Image sensor	1/4" DIS
Signal system	PAL / NTSC
Effective pixels	640 (H) × 480 (V)
Min. illumination	0.1 lux @ (F1.2, AGC on), 0 lux with IR 0.2 lux @ (F1.8, AGC on), 0 lux with IR
Shutter time	PAL: 1/25 s to 1/15,000 s NTSC: 1/30 s to 1/15,000 s
Lens	2.8 mm @ F1.8 (3.6 mm, 6 mm optional) Angle of view: 66.2° (2.8 mm)
Lens mount	M12
Day & night	IR cut filter with auto switch
Horizontal resolution	500 TVL
Synchronization	Internal synchronization
Video output	1 Vp-p composite output (75 Ω/BNC)
S/N ratio	More than 52dB
BLC	On
<b>General</b>	
Operating conditions	-40 °C ~ 70 °C (-40°F ~@ 158 °F) Humidity 90% or less (non-condensing)
Power supply	12 VDC ± 10%
Power consumption	1W (Max. 2.5W with IR cut filter on)
Weather-proof rating	IP66
IR range	Approx 10 to 20 meters
Dimensions	Φ 65 × 104 mm (Φ 2.56" × 4.09")
Weight	250g (0.55 lbs)

## Available models

DS-2CC1132P-IR, DS-2CC1132N-IR

# DS-2CC1173P-VF(IR) Weather-proof IR Bullet Camera

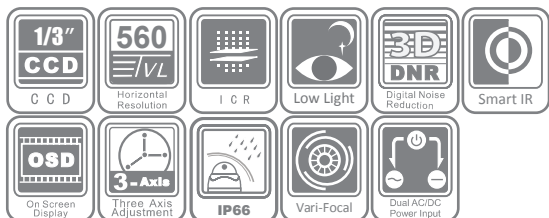

## Key Features

- 1/3" Sony Super HAD CCD II
- Low illumination
- True day / night
- 3-axis adjustment
- 3D digital noise reduction
- IP66 rating

## Dimensions

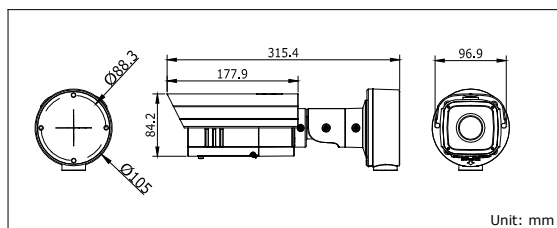

## Specifications

DS-2CC1173P-VF(IR)	
<b>Camera</b>	
Image sensor	1/3" Sony Super HAD CCD II
Signal system	PAL
Effective pixels	752 (H) × 582 (V)
Min. illumination	Color: 0.1 lux@F1.2, AGC on, 0.0003 lux@F1.2, AGC on, sens-up × 256 Color: 0.14 lux@F1.4, AGC on, 0.0004 lux@F1.4, AGC on, sens-up × 256 B/W: 0.01 lux@F1.2, AGC on, 0.00003 lux@F1.2, AGC on, sens-up × 256 B/W: 0.014 lux@F1.4, AGC on, 0.00004 lux@F1.4, AGC on, sens-up × 256 -IR: 0.1 lux@F1.2, AGC on, 0.0003 lux@F1.2, AGC on, sens-up × 256, 0 lux with IR 0.14 lux@F1.4, AGC on, 0.0004 lux@F1.4, AGC on, sens-up × 256, 0 lux with IR
Shutter time	1/50s ~ 1/100,000s
Lens	2.8 ~ 12mm @F1.4 Angle of view: 92 ~ 27.2°
Lens mount	φ 14
Auto iris	DC drive
Angle adjustment	Pan: 0 ~ 360°, tilt: 0 ~ 90°, rotation: 0 ~ 360°
Day & night	IR cut filter with auto switch
Horizontal resolution	Color: 560 TVL, B/W: 600 TVL
Synchronization	Internal / power synchronization
Video output	1Vp-p composite output (75 Ω / BNC) Test monitor out [1Vp-p composite output (75 Ω / BNC), device line]
S/N ratio	More than 52 dB
<b>Menu</b>	
Camera ID	On / off (15 letters, adjusted position)
Auto gain control	Low / middle / high / off
D/N mode	Auto / day / night
Auto white balance	Auto trace WB1 / auto trace WB2 / manual / auto control
Privacy mask	On / off, maximum 8 zones
Motion detection	On / off
BLC	Area / value / off
Eclipse	On / off
Digital WDR	Indoor / outdoor / off
Anti-flicker	On / off
Language	English / Chinese
Video	SMART IR, digital WDR, excessive high light compensation, gamma correction, digital zoom, digital noise reduction, POS / NEG ,mirror, sharpness, Y, C, blemish detection
<b>General</b>	
Operating conditions	-10°C ~ 60°C (14°F ~ 140°F) Humidity 90% or less (non-condensing)
Power supply	24 VAC ± 10%, 12 VDC ± 10%
Weather-proof rating	IP66
IR range	-IR: approx. 20 ~ 30 meters
Power consumption	3.5W max. -IR: 10W max.
Dimensions	97 x 87 x 314mm (3.82" × 3.42" × 12.36")
Weight	2100g (4.62 lbs)

## Available models

DS-2CC1173P-VF, DS-2CC1173P-VFIR

# DS-2CC1192P-IRA Weather-proof Bullet Camera



## Specifications

DS-2CC1192P-IRA	
<b>Camera</b>	
Image sensor	1/3" Sony EXVIEW HAD CCD II
Signal system	PAL
Effective pixels	976 (H) × 582 (V)
Min. illumination	0.001 lux@F1.2, AGC on, 0 lux with IR 0.0014 lux@F1.4, AGC on, 0 lux with IR
Shutter time	1/50s ~ 1/100,000s
Lens	25mm @ F1.4 (16mm optional) Angle of view: 13.5° (25mm)
Lens mount	CS mount
Day & night	Electronic
Horizontal resolution	650 TVL
Synchronization	Internal synchronization
Video output	1Vp-p composite output (75Ω / BNC)
S/N ratio	More than 62 dB
BLC	On
<b>General</b>	
Operating conditions	-30°C ~ 60°C (-22°F ~ 140°F) Humidity 90% or less (non-condensing)
Power supply	24 VAC ± 10% (12 VDC ± 10% Optional)
Power consumption	15W max.
Weather-proof rating	IP66
IR range	Approx. 100 ~ 110m
Dimensions	116.8 × 97.3 × 255.1mm (4.60" × 3.83" × 10.04")
Weight	2500g (5.50 lbs)

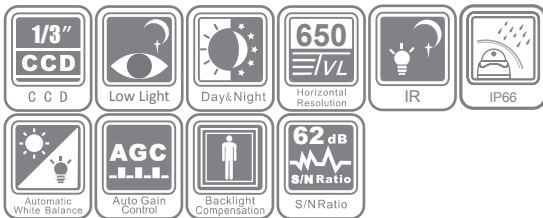

## Key Features

- 1/3" Sony EXVIEW HAD CCD II
- 650 TVL high resolution
- Up to 110m IR range
- Super low illumination
- Day / night auto switch
- IP66 rating

## Dimensions

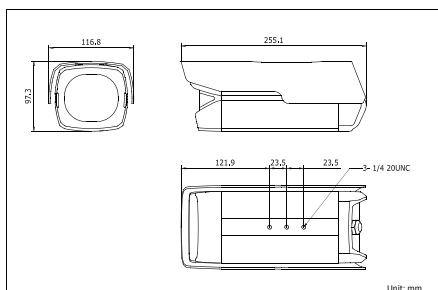

## Accessories



DS-1212ZJ-S  
(Indoor wall mount)

DS-1213ZJ-S  
(Outdoor wall mount)

## Available models

DS-2CC1192P-IRA

# DS-2CC502/572P(N)-IMB Vandal-Proof IR Dome Camera



## Key Features

- Compact structure design
- 1/3" Sony CCD
- Day / night auto switch
- Low illumination
- Rich image enhancements
- IP66 rating

## Dimensions

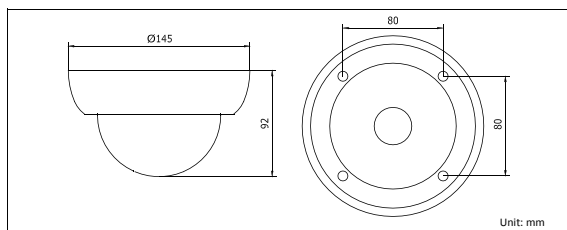

## Specifications

	DS-2CC502P(N)-IMB	DS-2CC572P(N)-IMB
<b>Camera</b>		
Image sensor	1/3" Sony CCD	
Signal system	PAL / NTSC	
Effective pixels	PAL: 500 (H) × 582 (V) NTSC: 510 (H) × 492 (V)	PAL: 752 (H) × 582 (V) NTSC: 768 (H) × 494 (V)
Min. illumination	0.1 lux@F1.2, AGC on, 0 lux with IR	
Shutter time	PAL: 1/50s ~ 1/100,000s NTSC: 1/60s ~ 1/100,000s	
Lens	3.6mm (2.8mm, 6mm optional) Angle of view: 78° (3.6mm)	
Lens mount	M12	
Angle adjustment	Pan: 0 ~ 355°; tilt: 0 ~ 65°;	
Day & night	Electronic	
Horizontal resolution	420 TVL	540 TVL
Synchronization	Internal synchronization	
Video output	1Vp-p composite output (75 Ω / BNC)	
S/N ratio	More than 48 dB	
BLC	On	
<b>General</b>		
Operating conditions	-10°C ~ 60°C (14°F ~ 140°F) Humidity 90% or less (non-condensing)	
Impact protection	IEC 60068-2-75 test, Eh, 50J; EN 50102, up to IK10.	
Weather-proof rating	IP66	
IR range	Approx 10 ~ 20 meters	
Power supply	12 VDC ± 10%	
Power consumption	3W max.	
Dimensions	Φ 108 × 70 mm (Φ 4.25" × 2.76")	
Weight	450g (0.99 lbs)	

## Available models

DS-2CC502P-IMB, DS-2CC572P-IMB  
DS-2CC502N-IMB, DS-2CC572N-IMB

# DS-502/512/592P(N)-IR/IR3 IR Dome Camera



## Key Features

- Compact design
- 1/3" Sony CCD
- Low illumination
- Day / night auto switch
- Rich image enhancements
- IP66 rating

## Dimensions

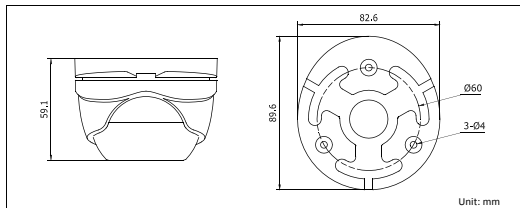

DS-502/512/592P(N)-IR

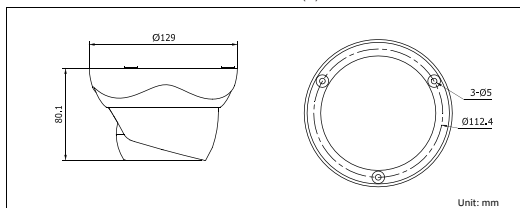

DS-502/512/592P(N)-IR3

## Specifications

	DS-2CC502P(N)-IR(IR3)	DS-2CC512P(N)-IR(IR3)	DS-2CC592P(N)-IR(IR3)
<b>Camera</b>			
Image sensor	1/3" Sony CCD		
Signal system	PAL / NTSC		
Effective pixels	PAL: 500 (H) × 582 (V) NTSC: 510 (H) × 492 (V)	PAL: 752 (H) × 582 (V) NTSC: 768 (H) × 494 (V)	PAL: 752 (H) × 582 (V) NTSC: 768 (H) × 494 (V)
Min. illumination	0.1 lux@F1.2, AGC on, 0 lux with IR 0.2 lux@F1.8, AGC on, 0 lux with IR		
Shutter time	PAL: 1/50s ~ 1/100,000s NTSC: 1/60s ~ 1/100,000s		
Lens	6mm @ F1.8 (3.6mm, 2.8mm optional) Angle of view: 47° (6mm)		
Lens mount	M12		
Angle adjustment	Pan: 0 ~ 355°; tilt: 0 ~ 75°;		
Day & night	Electronic		
Horizontal resolution	420 TVL	480 TVL	540 TVL
Synchronization	Internal synchronization		
Video output	1Vp-p composite output (75Ω / BNC)		
S/N ratio	More than 48 dB		
BLC	On		
<b>General</b>			
Operating conditions	-10°C ~ 60°C (14°F ~ 140°F) Humidity 90% or less (non-condensing)		
Power supply	12 VDC ± 10%		
Power consumption	3W max		
Weather-proof rating	IP66		
IR range	"-IR" series: approx 10 ~ 20 meters "-IR3" series: approx 30 ~ 40 meters		
Dimensions	"-IR" series: Φ 89.6 × 59.1mm (Φ 3.53" × 2.33") "-IR3" series: Φ 129 × 80.1mm (Φ 5.08" × 3.15")		
Weight	"-IR" series: 400g (0.88 lbs) "-IR3" series: 700g (1.54 lbs)		

## Available models

DS-2CC502P-IR1, DS-2CC502N-IR, DS-2CC512P-IR, DS-2CC512N-IR, DS-2CC592P-IR, DS-2CC592N-IR  
DS-2CC502P-IR3, DS-2CC502N-IR3, DS-2CC512P-IR3, DS-2CC512N-IR3, DS-2CC592P-IR3, DS-2CC592N-IR3

# DS-2CC5192P-IR1/IR3 IR Weather-proof Dome Camera

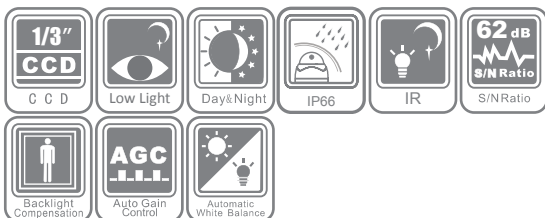

## Key Features

- High performance Sony CCD
- 650 TVL high resolution
- Up to 40m IR range
- Super low illumination
- Day / night auto switch
- IP66 rating

## Dimensions

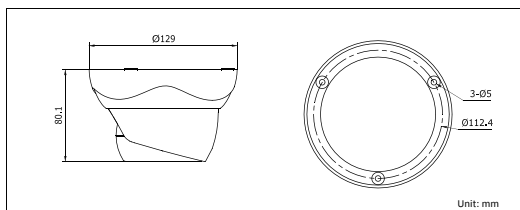

## Specifications

DS-2CC5192P-IR1/IR3	
<b>Camera</b>	
Image sensor	1/3" Sony EXVIEW HAD CCD II
Signal system	PAL / NTSC
Effective pixels	PAL: 976 (H) × 582 (V) NTSC: 976 (H) × 494 (V)
Min. illumination	0.001 lux@F1.2, AGC on, 0 lux with IR 0.002 lux@F1.8, AGC on, 0 lux with IR
Shutter time	PAL: 1/50s ~ 1/100,000s NTSC: 1/60s ~ 1/100,000s
Lens	6mm @F1.8 (3.6mm, 2.8mm optional) Angle of view: 47° (6mm)
Lens mount	M12
Angle adjustment	Pan: 0 ~ 355°; Tilt: 0 ~ 75°;
Day / night	Electronic
Horizontal resolution	650 TVL
Synchronization	Internal synchronization
Video output	1Vp-p composite output (75Ω / BNC)
S/N ratio	More than 62 dB
BLC	On
<b>General</b>	
Operating conditions	-30°C ~ 60°C (-22°F ~ 140°F) Humidity 90% or less (non-condensing)
Power supply	12 VDC ± 10%
Power consumption	3W max.
Weather-proof rating	IP66
IR range	"-IR1" series: approx 10 ~ 20 meters "-IR3" series: approx 30 ~ 40 meters
Dimensions	Φ 129 × 80.1 mm (Φ 5.08" × 3.15")
Weight	700g (1.54 lbs)

## Available models

DS-2CC5192P-IR1, DS-2CC5192P-IR3

# DS-2CC5132P(N)-IR IR Weather-proof DIS Dome Camera

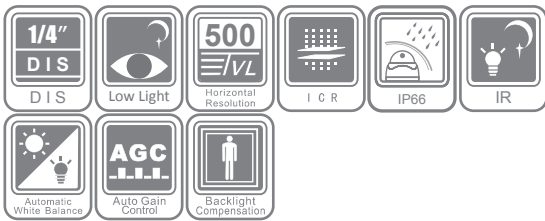

### Key Features

- 1/4" DIS
- 500 TVL resolution
- 20m IR range
- Low illumination
- True day / night
- IP66 rating

### Dimensions

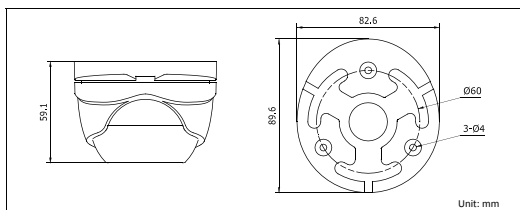

### Specifications

DS-2CC5132P(N)-IR	
<b>Camera</b>	
Image sensor	1/4" DIS
Signal system	PAL / NTSC
Effective pixels	640(H) × 480(V)
Min. illumination	0.1 Lux @ (F1.2, AGC ON) 0.28 Lux @ (F2.0, AGC ON)
Shutter time	PAL: 1/25s ~ 1/15,000s NTSC: 1/30s ~ 1/15,000s
Lens	2.8mm @ F1.8 (3.6mm, 6mm optional) Angle of view: 66.2° (2.8mm)
Lens mount	M12
Angle adjustment	Pan: 0 ~ 355°; Tilt: 0 ~ 75°
Day & night	IR cut filter with auto switch
Horizontal resolution	500 TVL
Synchronization	Internal synchronization
Video output	1Vp-p composite output (75 Ω / BNC)
S/N ratio	More than 52dB
<b>General</b>	
Operating conditions	-40°C ~ 70°C (-40°F ~ 158°F) Humidity 90% or less (non-condensing)
Power supply	12 VDC ± 10%
Power consumption	1W (2.5W max with IR cut filter on)
Weather-proof rating	IP66
Dimensions	Φ 89.6 × 59.1mm (Φ 3.53" × 2.33")
Weight	400g (0.88 lbs)

### Available models

DS-2CC5132P-IR, DS-2CC5132N-IR

# DS-2CC5132P(N)-IRP IR DIS Dome Camera



## Specifications

DS-2CC5132P(N)-IRP	
<b>Camera</b>	
Image sensor	1/4" DIS
Signal system	PAL / NTSC
Effective pixels	640(H) × 480(V)
Min. illumination	0.1 lux @ F1.2, AGC on, 0 lux with IR 0.2 lux @ F1.8, AGC on, 0 lux with IR
Shutter time	1/25 (1/30)s ~ 1/15,000s
Lens	2.8mm @ F1.8 (6mm, 3.6mm optional) Angle of view: 66.2° (2.8mm)
Lens mount	M12
Day / night	IR cut filter with auto switch
Horizontal resolution	500 TVL
Synchronization	Internal synchronization
Video output	1Vp-p composite output (75 Ω / BNC)
S/N ratio	More than 52 dB
BLC	On
<b>General</b>	
Operating conditions	-40°C ~ 70°C (40°F ~ 158°F) Humidity 90% or less (non-condensing)
Power supply	12 VDC ± 10%
Power consumption	1W (2.5W max with IR cut filter on)
IR range	approx 10 ~ 20 meters
Dimensions	Φ 89.5 × 69.8mm (Φ 3.52" × 2.75")
Weight	200g (0.44 lbs)

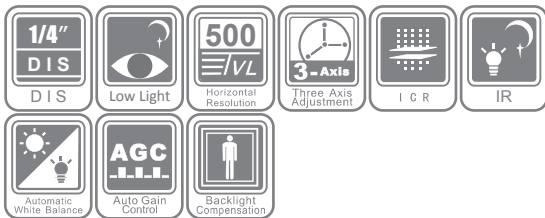

## Key Features

- 1/4" DIS
- 500 TVL resolution
- 20m IR range
- Low illumination
- True day / night
- 3-axis adjustment

## Dimensions

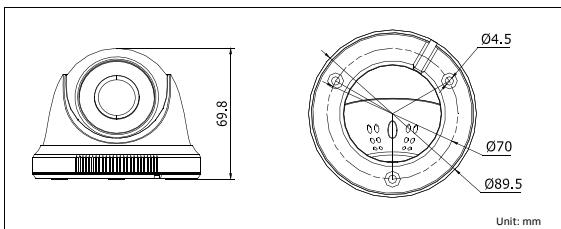

## Available models

DS-2CC5132P-IRP, DS-2CC5132N-IRP



# DS-2CZ2132P Zoom Camera

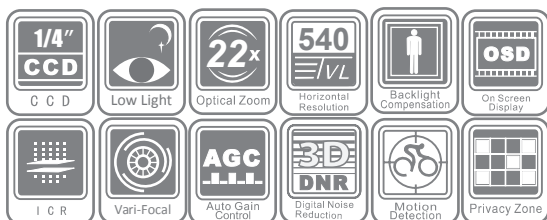

## Key Features

- 1/4" Sony Interline Transfer Super HAD-II CCD
- 22x optical zoom
- 540 TVL high resolution
- Low illumination
- OSD menu
- Day / night auto switch
- 3D digital noise reduction
- Electronic image stabilization

## Dimensions

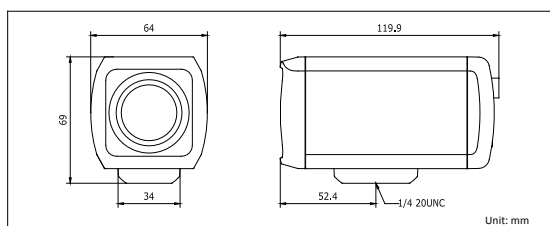

## Accessories



## Specifications

DS-2CZ2132P	
<b>Camera</b>	
Image sensor	1/4" Sony Interline Transfer Super HAD-II CCD
Signal system	PAL
Effective pixels	PAL: 752(H) × 582(V)
Min. illumination	Color: 0.2 lux@F1.6, AGC on, 0.0002 lux@F1.6, AGC on, sens-up × 512
Shutter time	1/50 (1/60)s ~ 1/100, 000s
Day & night	Electronic
Horizontal resolution	540 TVL
Synchronize mode	Internal
Video output	1 Vp-p Composite Output (75 Ω / BNC)
S/N ratio	>50 dB
<b>Lens</b>	
Focal length	3.9 ~ 85.8mm, 22x
Zoom speed	Approx. 3s (optical, wide-tele)
Horizontal viewing angle	49.6 ~ 2.40° (wide-tele)
Min. working distance	10 ~ 1500mm (wide-tele)
Aperture range	F1.6 ~ F3.7
<b>Menu</b>	
Camera ID	Off / on (0 ~ 254)
Iris mode	Auto / manual / electronic
Shutter	1/50 (1/60)s ~ 1/100, 000s
Auto gain control	Off / low / high
White balance	ATW 1 / ATW 2 / auto / manual
Focus	Auto / once / manual
Day & night	Auto / B/W / external trigger
Slow shutter	×512 max.
Privacy mask	Off / on, Up to 8 zones
Motion detection	Off / mode 1 / mode 2
Gamma correction	0.45 / 1
Video settings	3D-DNR, mirror, definition, flickerless, exposure-compensation, BLC, image freezing, electronic image stabilization
Zoom speed	Level 1 ~ 5 adjustable
Digital zoom	Off, ×2, ×4, ×6, ×8, ×10, ×12, ×14, ×16
Zoom ratio display	On / off
ZCF control mode	Mode 1 / mode 2
RS-485	Communication protocol / baud rate / address
Preset	254
Dead pixel detection	Yes
<b>General</b>	
Working temperature & humidity	-10°C ~ 60°C, Humidity: ≤ 90% (no condensation)
Power supply	12 VDC ± 10%
Power consumption	4W max.
Dimensions	64 × 69 × 120 mm
Weight	450g

## Available models

DS-2CZ2132P

# DS-2CZ2152P Zoom Camera

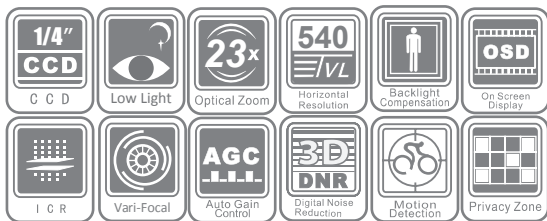

## Key Features

- 1/4" Sony Interline Transfer Super HAD-II CCD
- 23x optical zoom
- 540 TVL high resolution
- Low illumination
- OSD menu
- 3D digital noise reduction
- Electronic image stabilization
- Auto iris with DC / video drive

## Dimensions

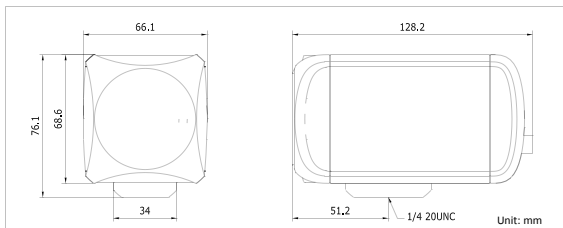

## Accessories

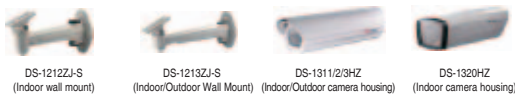

## Specifications

DS-2CZ2152P	
<b>Camera</b>	
Image sensor	1/4" Sony Interline Transfer Super HAD-II CCD
Signal system	PAL
Effective pixels	PAL: 752 (H) × 582 (V)
Min. illumination	Color: 0.2 lux@F1.6,AGC on, 0.0002 lux@F1.6, AGC on, sens-up × 512 B/W: 0.02 lux@F1.6,AGC on, 0.00002 lux@F1.6, AGC on, sens-up × 512
Shutter time	1/50 (1/60)s ~ 1/100, 000s
Day & night	IR cut filter with auto switch
Horizontal resolution	Color: 540 TVL, B/W: 600 TVL
Synchronize mode	Internal
Video output	1Vp-p composite output (75Ω / BNC)
S/N ratio	> 50 dB
<b>Lens</b>	
Focal length	3.84 ~ 88.4 mm, 23x
Zoom speed	Approx. 3s (optical, wide-tele)
Horizontal viewing angle	50.2 ~ 2.36° (wide-tele)
Min. working distance	10 ~ 1500mm (wide-tele)
Aperture range	F1.6 ~ F4.5
<b>Menu</b>	
Camera ID	Off / on (0 ~ 254)
Iris mode	Auto / manual / electronic
Shutter	1/50 (1/60)s ~ 1/100, 000s
AGC	Off / low / high
White balance	ATW 1 / ATW 2 / auto / manual
Focus	Auto / once / manual
Day & night	Auto / B/W / external trigger
Slow shutter	×512 max
Privacy mask	Off / on, up to 8 zones
Motion detection	Off / mode 1 / mode 2
Gamma correction	0.45 / 1
Video settings	3D-DNR, mirror, definition, flickerless, exposure-compensation, BLC, image freezing, electronic image stabilization
Zoom speed	Level 1-5 adjustable
Digital zoom	Off, ×2, ×4, ×6, ×8, ×10, ×12, ×14, ×16
Zoom ratio display	On / off
ZCF control mode	Mode 1 / Mode 2
RS-485	Communication protocol / baud rate / address
Preset	254
Dead pixel detection	Yes
<b>General</b>	
Working temperature & humidity	-10°C ~ 60°C, Humidity: ≤ 90% (no condensation)
Power supply	12 VDC ± 10%
Power consumption	4.5W max.
Dimensions	66× 76 × 128 mm
Weight	550g

## Available models

DS-2CZ2152P

# DS-2CZ282P(N) Zoom Camera

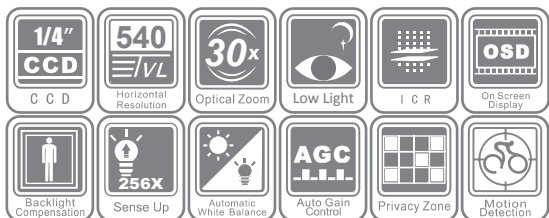

## Key Features

- 1/4" Sony Interline Transfer Super HAD-II CCD
- 30x optical zoom
- 540 TVL high resolution
- Low illumination
- OSD menu
- True day / night

## Dimensions

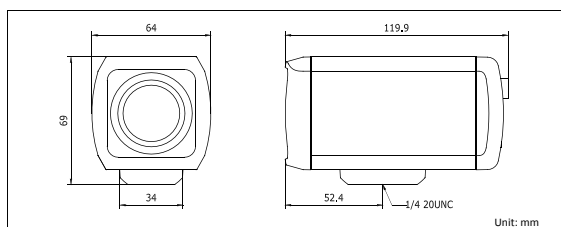

## Accessories



## Specifications

DS-2CZ282P(N)	
<b>Camera</b>	
Image sensor	1/4" SONY Interline Transfer Super HAD-II CCD
Signal system	PAL / NTSC
Effective pixels	PAL: 752 (H) × 582 (V) NTSC: 768 (H) × 494 (V)
Min. illumination	Color: 0.2 lux@F1.4, AGC on, 0.0008 lux@F1.4, AGC on, sens-up × 256 B/W: 0.02 lux@F1.4, AGC on, 0.0008 lux@F1.4, AGC on, sens-up × 256
Shutter time	1/50 (1/60)s ~ 1/100,000s
Day & night	IR cut filter with auto switch
Horizontal resolution	Color: 540 TVL, B/W: 600 TVL
Synchronize mode	Internal synchronization
Video output	1 Vp-p composite output (75Ω / BNC)
S/N ratio	> 50 dB
<b>Lens</b>	
Focal length	3.5 ~ 105.5 mm, 30x
Zoom speed	Approx. 5s (optical, wide-tele)
Horizontal viewing angle	56.4 ~ 2.0° (wide-tele)
Min. working distance	10 ~ 1500mm (wide-tele)
Aperture range	F1.4 ~ F3.7
<b>Menu</b>	
Camera ID	Off / on (0 ~ 254)
Iris mode	Auto / manual / electronic
Shutter	1/50 (1/60)s ~ 1/100,000s
Auto gain control	Off / low / high
White balance	ATW1 / ATW2 / AC / manual
Focus	Auto / once / manual
Day & night	Auto / color / B/W / external trigger
Privacy mask	Off / On, up to 8 zones
Motion detection	Off / mode 1 / mode 2
Gamma correction	0.45 / 1
Video settings	DNR, mirror, definition, Y-value, C-value, POS / NEG, flickerless
Zoom speed	1 ~ 5
Digital zoom	Off, ×2, ×4, ×6, ×8, ×10, ×12, ×14, ×16
Zoom ratio display	On / Off
ZCF control mode	Mode 1 / mode 2
RS-485	Protocol / baud Rate / address
Preset	254
Dead pixel detection	Yes
<b>General</b>	
Working temperature & humidity	-10 °C ~ 60 °C, Humidity: ≤ 90% (no condensation)
Power supply	12 VDC ± 10%
Power consumption	4.5W max.
Dimensions	66 × 76 × 128 mm
Weight	550g

## Available models

DS-2CZ282P, DS-2CZ282N

# DS-2CZ292P(N) Zoom Camera



## Specifications

DS-2CZ292P(N)	
<b>Camera</b>	
Image sensor	1/4" SONY Interline Transfer Super HAD-II CCD
Signal system	PAL / NTSC
Effective pixels	PAL: 752 (H) × 582 (V) NTSC: 768 (H) × 494 (V)
Min. illumination	Color: 0.2 lux@F1.6, AGC on, 0.0008 lux@F1.6, AGC on, sens-up × 256 B/W: 0.02 lux@F1.6, AGC on, 0.00008 lux@F1.6, AGC on, sens-up × 256
Shutter time	1/50 (1/60)s ~ 1/100,000s
Day & night	IR cut filter with auto switch
Horizontal resolution	Color: 540 TVL, B/W: 600 TVL
Synchronize mode	Internal synchronization
Video output	1 Vp-p composite output (75Ω / BNC)
S/N ratio	> 52dB
<b>Lens</b>	
Focal length	3.4 ~ 122.4 mm, 36x
Zoom speed	Approx. 6s (optical, wide-tele)
Horizontal viewing angle	57.8 ~ 1.7° (wide-tele)
Min. working distance	10 ~ 1500mm (wide-tele)
Aperture range	F1.6 ~ F4.5
<b>Menu</b>	
Camera ID	Off / on (0 ~ 254)
Iris mode	Auto / manual / electronic
Shutter	1/50 (1/60)s ~ 1/100,000s
Auto gain control	Off / low / high
White balance	ATW1 / ATW2 / AC / manual
Focus	Auto / once / manual
Day & night	Auto / color / B/W / external trigger
Privacy mask	Off / on, up to 8 zones
Motion detection	Off / mode 1 / mode 2
Gamma correction	0.45 / 1
Video settings	DNR, mirror, definition, Y-value, C-value, POS/NEG, flickerless
Zoom speed	Level 1~5 adjustable
Digital zoom	Off, ×2, ×4, ×6, ×8, ×10, ×12, ×14, ×16
Zoom ratio display	On / off
ZCF control mode	Mode 1 / mode 2
RS-485	Protocol / baud rate / address
Preset	254
Dead pixel detection	Yes
<b>General</b>	
Working temperature & humidity	-10°C ~ 60°C , Humidity: ≤ 90% (no condensation)
Power supply	12 VDC ± 10%
Power consumption	4.5W max.
Dimensions	66 × 76 × 128 mm
Weight	450g

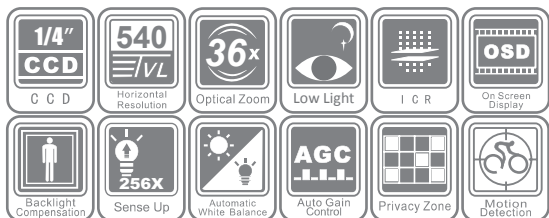

## Key Features

- 1/4" SONY Interline Transfer Super HAD-II CCD
- 36x optical zoom
- 540 TVL high resolution
- Low illumination
- OSD menu
- True day / night

## Dimensions

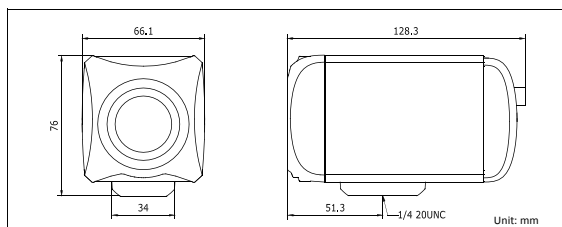

## Accessories



## Available models

DS-2CZ292P, DS-2CZ292N

# DVR/NVR





## Key Features

- H.264 video compression
- Third-party network cameras supported
- HDMI output at 1920×1080 resolution
- 4/8/16-ch synchronous playback
- HDD group management

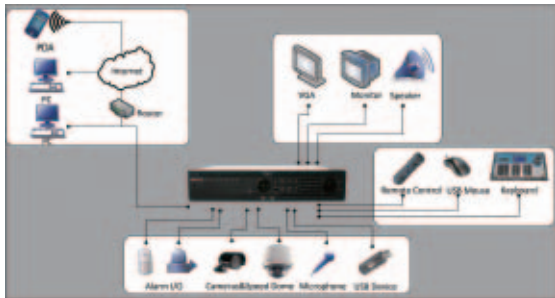

Rear Panel of DS-9016HFI-SH

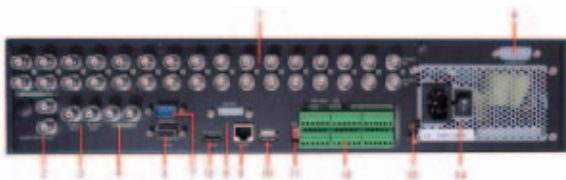

- |  |  |
|--|--|
| 1. Video in, audio in                                      | 9. LAN network interface   |
| 2. Video spot out (for video preview only), audio spot out | 10. USB interface  |
| 3. Video out, audio out                                    | 11. RS-485 matched resistance switch   |
| 4. Line in   | 12. RS-485 serial interface, keyboard Interface (support cascade), alarm in, alarm out |
| 5. VGA interface   | 13. GND  |
| 6. Loop out (optional)                                     | 14. 100~240 VAC power input  |
| 7. RS-232 serial interface                                 | 15. HDMI interface   |
| 8. eSATA backup/extended storage Interface (optional)      |  |

## Specifications

	DS-9004HFI-SH	DS-9008HFI-SH	DS-9016HFI-SH
<b>Video/Audio input</b>			
Video compression	H.264		
Analog Video input	4-ch, BNC (1.0Vp-p, 75Ω), PAL/NTSC self-adaptive	8-ch, BNC (1.0Vp-p, 75Ω), PAL/NTSC self-adaptive	16-ch, BNC (1.0Vp-p, 75Ω), PAL/NTSC self-adaptive
IP Video input	4-ch 4CIF / 2-ch 720P / 1-ch UXGA / 1080P real time	8-ch 4CIF / 4-ch 720P / 2-ch UXGA / 1080P real time	16-ch 4CIF / 8-ch 720P / 4-ch UXGA / 1080P real time
Composited video input	8-ch (4-ch analog video + 4-ch IP video)	16-ch (8-ch analog video + 8-ch IP video)	24-ch (16-ch analog video + 8-ch IP video)
Audio compression	OggVorbis		
Audio input	4-ch, BNC (2.0 Vp-p, 1 kΩ)	8-ch, BNC (2.0 Vp-p, 1 kΩ)	16-ch, BNC (2.0 Vp-p, 1 kΩ)
Voice talk input	2-ch, BNC (2.0 Vp-p, 1 kΩ)		
<b>Video/Audio output</b>			
Preview resolution	PAL:704×576 NTSC:704×480		
HDMI output	1-ch, resolution: 1920×1080 /60 Hz, 1280×1024 /60 Hz, 1024×768 /60 Hz		
VGA output	1-ch, resolution: 1280×1024 /60 Hz, 1024×768 /70 Hz, 1024×768 /60 Hz		
Encoding resolution	4CIF / DCIF / 2CIF / CIF / QCIF		
Video output	2-ch, BNC (1.0 Vp-p, 75 Ω)		
Video loop out	Optional		
Frame rate	25fps (P) / 30fps (N)		
Video bit rate	32 Kbps~2048 Kbps, or user defined (max. 6144 Kbps)		
Audio output	2-ch, BNC (linear electrical level, 600 Ω)		
Audio bit rate	16 Kbps		
Dual-stream	Support		
Stream type	Video, Video & Audio		
Synchronous playback	4-ch	8-ch	16-ch
<b>Hard disk</b>			
SATA	8 SATA interfaces		
Capacity	Up to 2TB capacity for each disk		
<b>External interface</b>			
Network interface	1, RJ45 10M / 100M / 1000M self-adaptive ethernet interface		
Serial interface	1 RS-232 interface (for parameters configuration, maintenance , transparent channel); 1 RS-485 interface (for PTZ control); 1 RS-485 keyboard interface (for special keyboard control)		
USB interface	3, USB 2.0		
Alarm in	16		
Alarm out	4		
<b>General</b>			
Power supply	100~240 VAC, 6.3A, 50~60Hz		
Consumption	≤ 70W (without hard disk or DVD-R/W)		
Working temperature	-10 °C ~ +55 °C		
Working humidity	10% ~ 90%		
Dimensions (W × D × H)	450 × 470 × 90 mm		
Weight	≤ 8kg (without hard disk or DVD-R/W)		

# DS-9004/9008/9016HFI-RH Embedded Hybrid DVR



## Key Features

- H.264 video compression
- Third-party network cameras supported
- HDMI output at 1920×1080 resolution
- 4/8/16-ch synchronous playback
- RAID 0, RAID 1, RAID 10 & RAID 5 supported
- Easy HDD assembly & replacement



Rear Panel of DS-9016HFI-RH

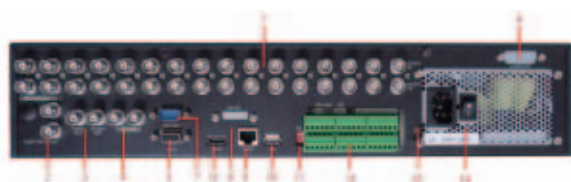

- |  |  |
|--|--|
| 1. Video in, audio in                                      | 9. LAN network interface   |
| 2. Video spot out (for video preview only), Audio spot out | 10. USB interface  |
| 3. Video out, audio out                                    | 11. RS-485 matched resistance switch   |
| 4. Line in   | 12. RS-485 serial interface, keyboard interface (support cascade), alarm in, alarm out |
| 5. VGA interface   | 13. GND  |
| 6. Loop out (optional)                                     | 14. 100~240 VAC power input  |
| 7. RS-232 serial interface                                 | 15. HDMI interface   |
| 8. eSATA backup / extended storage interface (optional)    |  |

## Specifications

	DS-9004HFI-RH	DS-9008HFI-RH	DS-9016HFI-RH
<b>Video/Audio input</b>			
Video compression	H.264		
Analog video input	4-ch, BNC (1.0 Vp-p, 75 Ω), PAL/NTSC self-adaptive	8-ch, BNC (1.0 Vp-p, 75 Ω), PAL/NTSC self-adaptive	16-ch, BNC (1.0 Vp-p, 75 Ω), PAL/NTSC self-adaptive
IP video input	4-ch 4CIF / 2-ch 720P / 1-ch UXGA real time	8-ch 4CIF / 4-ch 720P / 2-ch UXGA real time	16-ch 4CIF / 8-ch 720P / 4-ch UXGA real time
Composited video input	8-ch (4-ch analog video + 4-ch IP video)	16-ch (8-ch analog video + 8-ch IP video)	24-ch (16-ch analog video + 8-ch IP video)
Audio compression	OggVorbis		
Audio input	4-ch, BNC (2.0 Vp-p, 1 kΩ)	8-ch, BNC (2.0 Vp-p, 1 kΩ)	16-ch, BNC(2.0 Vp-p, 1 kΩ)
Voice talk input	2-ch, BNC (2.0 Vp-p, 1 kΩ)		
<b>Video/Audio output</b>			
Preview resolution	PAL: 704×576, NTSC: 704×480		
HDMI output	1-ch, Resolution: 1024 × 768 /60 Hz, 1280 × 1024 /60 Hz, 1920 × 1080 /60 Hz		
VGA output	1-ch, Resolution: 1024 × 768 /60 Hz, 1024 × 768 /70 Hz, 1280 × 1024 /60 Hz		
Encoding resolution	4CIF / DCIF / 2CIF / CIF / QCIF		
Video output	2-ch, BNC (1.0 Vp-p, 75 Ω)		
Video loop out	Optional		
Frame rate	25 fps(P)/30 fps(N)		
Video bit rate	32 Kbps-2048 Kbps, or user defined (Max. 6144 Kbps)		
Audio output	2-ch, BNC (Linear Electrical Level, 600 Ω)		
Audio bit rate	16 Kbps		
Dual-stream	Support		
Stream type	Video, Video & Audio		
Synchronous playback	4-ch	8-ch	16-ch
<b>Hard disk</b>			
SATA	8 SATA interfaces		
Capacity	Up to 2TB capacity for each disk		
Array type	RAID 0, RAID 1, RAID 5, RAID 10		
Array number	4		
Virtual disk	8		
<b>External interface</b>			
Network interface	1, RJ45 10 M / 100M / 1000M self-adaptive ethernet interface		
Serial interface	1 RS-232 interface (for parameters configuration, maintenance, transparent channel); 1 RS-485 interface (for PTZ control); 1 RS-485 keyboard interface (for special keyboard control)		
USB interface	3, USB 2.0		
Alarm in	16		
Alarm out	4		
<b>General</b>			
Power supply	100 ~ 240 VAC, 6.3A, 50~60Hz		
Consumption	≤ 70W (without hard disk or DVD-R/W)		
Working temperature	-10 °C ~ +55 °C		
Working humidity	10% ~ 90%		
Dimensions (W × D × H)	445 × 470 × 90 mm		
Weight	≤ 8kg (without hard disk or DVD-R/W)		

# DS-7604HI-S Embedded Hybrid DVR



## Key Features

- H.264 video compression
- Up to 5 Megapixels (2560×1920) resolution recording
- VGA output at 1024×768 resolution
- Dual-stream
- 4-ch synchronous playback

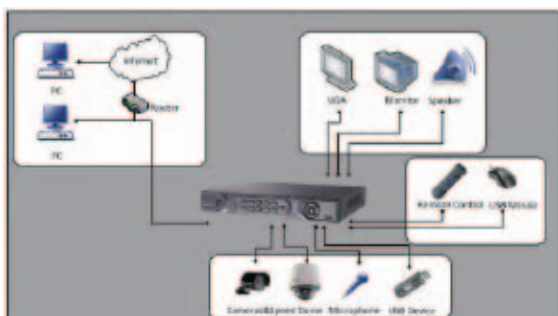

Rear Panel of DS-7604HI-S



- |                  |  |
|------------------|--|
| 1. USB Interface | 7. VGA interface                         |
| 2. Video in      | 8. RS-485 Interface, alarm in, alarm out |
| 3. Video out     | 9. Power switch                          |
| 4. Audio in      | 10. 12 VDC power supply                  |
| 5. Audio out     | 11. GND                                  |
| 6. LAN           |  |

## Specifications

DS-7604HI-S	
<b>Video/Audio input</b>	
Video compression	H.264
Analog video input	4-ch, BNC (1.0 Vp-p, 75 Ω), PAL / NTSC self-adaptive
IP video input	2-ch 4CIF real time or 1-ch 720P / UXGA / 1080P real time ; 3-ch 4CIF real time or 1-ch 720P / UXGA / 1080P real time ; 4-ch 4CIF real time/2-ch 720P / UXGA / 1080P real time or 1-ch 2560×1920 not real time ;
Composite video input	6-ch (4-ch analog video+ 2-ch IP video)
Audio compression	OggVorbis
Audio input	1-ch, RCA (2.0 Vp-p, 1 kΩ)
<b>Video/Audio output</b>	
Live view resolution	PAL:704×576, NTSC:704×480
VGA output	1-ch, resolution: 1024×768 / 60Hz
Playback resolution	2560×1920 / UXGA / 1080P / 720P / 4CIF / VGA / DCIF / 2CIF / CIF / QCIF
Video output	1-ch, BNC (PAL: 704×576, NTSC: 704×480)
Frame rate	25 fps (P) / 30fps (N)
Video bit rate	32 Kbps~2048 Kbps, or user defined (Max. 16384 Kbps)
Audio output	1-ch, RCA(2.0 Vp-p, 1 kΩ)
Audio bit rate	16kbps
Synchronous playback	4-ch
<b>Hard disk</b>	
SATA	1 SATA interface
Capacity	Up to 2TB capacity for each disk
<b>External interface</b>	
Network interface	1, RJ45 10M / 100M self-adaptive ethernet interface
Serial interface	1 RS-485 interface
USB interface	2, USB2.0
Alarm in	4
Alarm out	1
<b>General</b>	
Power supply	12 VDC
Consumption	≤ 12W (without hard disk or DVD-R/W)
Working temperature	-10°C ~ 55°C (14°F ~ 131°F)
Working humidity	10%~90%
Dimensions (W x D x H)	315 × 230 × 45 mm
Weight	≤ 2.5kg (without HDD or DVD-R/W)



# DS-9104/9108/9116HFI-ST Standalone DVR



## Key Features

- H.264 video compression
- HDMI and VGA output at 1920×1080P resolution
- HDD quota and group management
- Dual-stream
- Dual gigabit network interfaces
- 4/8/16-ch synchronous playback

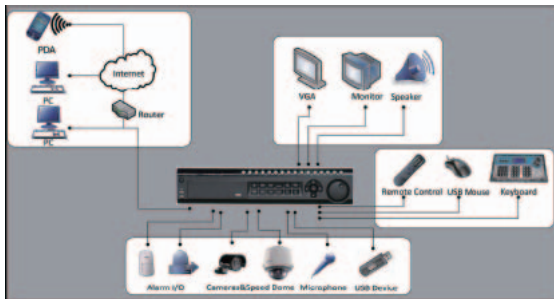

Rear Panel of DS-9116HFI-ST



1. Video in
2. Video loop out
3. Video spot out
4. Video out
5. CVBS audio out, VGA audio out
6. Line in
7. Audio in, RCA connector
8. Audio in, DB26 connector
9. RS-232 serial interface
10. VGA interface
11. HDMI interface
12. eSATA interface
13. LAN1, LAN2 network interface
14. Termination switch
15. RS-485 serial interface, keyboard Interface, alarm in, alarm out
16. GND
17. 100~240VAC power input
18. Power switch

## Specifications

	DS-9104HFI-ST	DS-9108HFI-ST	DS-9116HFI-ST
<b>Video/Audio input</b>			
Video compression	H.264		
video input	4-ch, BNC(1.0 Vp-p, 75 Ω), PAL / NTSC self-adaptive	8-ch, BNC(1.0 Vp-p, 75 Ω), PAL / NTSC self-adaptive	16-ch, BNC(1.0 Vp-p, 75 Ω), PAL / NTSC self-adaptive
Video input interface	BNC (1.0 Vp-p, 75 Ω), PAL/TSC self-adaptive		
Audio compression	OggVorbis		
Audio input	4-ch, RCA (2.0 Vp-p, 1 kΩ)	8-ch, Audio 1-4: RCA (2.0 Vp-p, 1 kΩ) Audio 5-8: DB26 connector	16-ch, Audio 1-4: RCA (2.0 Vp-p, 1 kΩ) Audio 5-16: DB26 connector
Voice talk input	1-ch, RCA (2.0 Vp-p, 1 kΩ)		
<b>Video/Audio output</b>			
HDMI output	1-ch, resolution:1024×768 /60 Hz, 1280×720 /60 Hz, 1280×1024 /60 Hz, 1600×1200 /60 Hz, 1920×1080P /50 Hz, 1920×1080P /60 Hz		
VGA output	1-ch, resolution:1024×768 /60 Hz, 1280×720 /60 Hz, 1280×1024 /60 Hz, 1600×1200 /60 Hz, 1920×1080P /60 Hz		
CVBS output	1-ch, BNC (1.0 Vp-p, 75 Ω), resolution: PAL: 704×576, NTSC: 704×480		
Video spot output	1-ch, BNC (1.0 Vp-p, 75 Ω), resolution: PAL: 704×576, NTSC: 704×480	4-ch, BNC (1.0 Vp-p, 75 Ω), resolution: PAL: 704×576, NTSC: 704×480	4-ch, BNC (1.0 Vp-p, 75 Ω), resolution: PAL: 704×576, NTSC: 704×480
Video loop out	4-ch	8-ch	16-ch
Encoding resolution	4CIF / 2CIF / CIF / QCIF		
Frame rate	25fps(P) / 30fps(N)		
Video bit rate	32Kbps - 2048Kbps, or user defined (Max. 8192 Kbps)		
Audio output	2-ch, RCA (2.0 Vp-p, 1 kΩ)		
Audio bit rate	16kbps		
Dual-stream	Support		
Stream type	Video, Video & Audio		
Playback resolution	4CIF / 2CIF / CIF / QCIF		
Synchronous playback	4-ch	8-ch	16-ch
<b>Hard disk</b>			
SATA	8 SATA interfaces		
eSATA	1 eSATA interface		
Capacity	Up to 4TB capacity for each disk		
<b>External interface</b>			
Network interface	2, RJ45 10M / 100M / 1000M self-adaptive ethernet interface		
Serial interfaces	1 RS-232 interface (for parameters configuration, maintenance, transparent channel); 1 RS-485 interface (for PTZ control); 1 RS-485 keyboard interface (for special keyboard control)		
USB interface	2, USB2.0		
Alarm in	4	16	16
Alarm out	2	4	4
<b>General</b>			
Power supply	100~240 VAC, 6.3A, 50~60Hz		
Consumption	≤ 70W (without hard disk or DVD-R/W)		
Working temperature	-10°C ~ +55°C		
Working humidity	10% ~ 90%		
Chassis	19-inch rack-mounted 2U chassis		
Dimensions (W x D x H)	445 × 470 × 90 mm		
Weight	≤ 8kg (without hard disk or DVD-R/W)		

# DS-9104/9108/9116HWI-ST Standalone DVR

## Specifications

	DS-9104HWI-ST	DS-9108HWI-ST	DS-9116HWI-ST
<b>Video/Audio input</b>			
Video compression	H.264		
Analog video input	4-ch, BNC(1.0 Vp-p, 75 Ω), PAL / NTSC self-adaptive	8-ch, BNC(1.0 Vp-p, 75 Ω), PAL / NTSC self-adaptive	16-ch, BNC(1.0 Vp-p, 75 Ω), PAL / NTSC self-adaptive
Audio compression	OggVorbis		
Audio input	4-ch, RCA (2.0 Vp-p, 1 kΩ)	8-ch, Audio 1-4: RCA (2.0 Vp-p, 1 kΩ) Audio 5-8: DB26 connector	16-ch, Audio 1-4: RCA (2.0 Vp-p, 1 kΩ) Audio 5-16: DB26 connector
Voice talk input	1-ch, BNC (2.0 Vp-p, 1 kΩ)		
<b>Video/Audio output</b>			
HDMI / VGA output	1-ch, resolution: 1024×768 /60 Hz, 1280×720 /60 Hz, 1280×1024 /60 Hz, 1600×1200 /60 Hz, 1920×1080 /60 Hz(1080P)		
CVBS output	1-ch, BNC (1.0 Vp-p, 75 Ω), resolution: PAL: 704×576, NTSC: 704×480		
Video spot output	1-ch, BNC (1.0 Vp-p, 75 Ω), resolution: PAL: 704×576, NTSC: 704×480	4-ch, BNC (1.0 Vp-p, 75 Ω), resolution: PAL: 704×576, NTSC: 704×480	4-ch, BNC (1.0 Vp-p, 75 Ω), resolution: PAL: 704×576, NTSC: 704×480
Video loop out	4-ch	8-ch	16-ch
Encoding resolution	WD1 / 2CIF / CIF / QCIF		
Frame rate	25fps (P) / 30fps (N)		
Video bit rate	32 Kbps-2048 Kbps, or user defined (Max. 8196 Kbps)		
Audio output	2-ch, RCA (2.0 Vp-p, 1 kΩ)		
Audio bit rate	16kbps		
Dual-stream	Support		
Stream type	Video, Video & Audio		
Playback resolution	WD1/ 2CIF / CIF / QCIF		
Synchronous playback	4-ch	8-ch	16-ch
<b>Hard disk</b>			
SATA	8 SATA interfaces		
eSATA	1 eSATA interface		
Capacity	Up to 4TB capacity for each disk		
<b>External interface</b>			
Network interface	2, RJ45 10M / 100M / 1000M self-adaptive ethernet interface		
Serial interface	1 RS-232 interface (for parameters configuration, maintenance, transparent channel); 1 RS-485 interface (for PTZ control); 1 RS-485 keyboard interface (for special keyboard control)		
USB interface	2, USB2.0		
Alarm in	4	16	16
Alarm out	2	4	4
<b>General</b>			
Power supply	100~240 VAC, 6.3A, 50~60Hz		
Consumption	≤ 70W (without hard disk or DVD-R/W)		
Working temperature	-10°C ~ +55°C (14°F ~ 131°F)		
Working humidity	10% ~ 90%		
Chassis	19-inch rack-mounted 2U chassis		
Dimensions (W x D x H)	445 × 470 × 90 mm		
Weight	≤ 8kg (without hard disk or DVD-R/W)		



## Key Features

- H.264 video compression
- HDMI and VGA output at 1920×1080P resolution
- HDD quota and group management
- WD1(PAL: 960×576, NTSC: 960×480 ) resolution real time recording
- Dual gigabit network interfaces
- 4/8/16-ch synchronous playback



Rear Panel of DS-9116HWI-ST



1. Video in
2. Video loop out
3. Video spot out
4. Video out
5. CVBS audio out, VGA audio out
6. Line in
7. Audio in, RCA connector
8. Audio in, DB26 connector
9. RS-232 serial interface
10. VGA interface
11. HDMI interface
12. eSATA interface
13. LAN1, LAN2 network interface
14. Termination switch
15. RS-485 serial interface, keyboard Interface, alarm in, alarm out
16. GND
17. 100-240 VAC power input
18. Power switch

# DS-8104/8108/8116HCI-ST Standalone DVR



## Key Features

- H.264 video compression
- Up to 4CIF resolution recording
- VGA output at 1280 ×1024 resolution
- Simultaneous VGA, main CVBS and spot video outputs
- Dual-stream
- 4/8/16-ch synchronous playback
- SADP(IP Finder), NTP ,NDP , DHCP protocols



Rear Panel of DS-8116HCI-ST

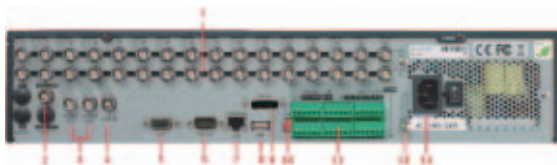

- |                         |  |
|-------------------------|--|
| 1. Video in, audio in   | 8. USB interface   |
| 2. Video spot out       | 9. eSATA interface   |
| 3. Video out, audio out | 10. Termination switch                                     |
| 4. Line in              | 11. RS-485 interface, controller port, alarm in, alarm out |
| 5. VGA                  | 12. GND  |
| 6. RS-232               | 13. 100-240 VAC power supply                               |
| 7. LAN interface        |  |

## Specifications

	DS-8104HCI-ST	DS-8108HCI-ST	DS-8116HCI-ST
<b>Video/Audio input</b>			
Analog video input	4-ch BNC connector (1.0 Vp-p, 75 Ω); PAL / NTSC self-adaptive	8-ch	16-ch
Audio input	4-ch BNC connector (2.0 Vp-p, 1 kΩ)	8-ch	16-ch
Voice talk input	1-ch, BNC connector (2.0 Vp-p, 1 kΩ)		
<b>Video/Audio output</b>			
CVBS output	1-ch, BNC connector (1.0 Vp-p, 75 Ω); Resolution: PAL: 704×576, NTSC:704×480		
VGA output	1-ch, resolution: 1280×1024 /60 Hz , 1024×768 /60 Hz		
Audio output	1-ch, BNC connector (2.0 Vp-p, 600 Ω)		
<b>Video/Audio encoding</b>			
Video compression	H.264		
Encoding resolution	4CIF / 2CIF / CIF		
Frame rate	25fps (P) / 30fps (N)		
Video bit rate	32 kbps~2048 kbps, or user defined (Max. 3072 kbps)		
Stream type	Video, Video & Audio		
Dual-stream	Support		
Audio compression	G.711		
Audio bit rate	64kbps		
Synchronous playback	4-ch	8-ch	16-ch
<b>Hard disk</b>			
SATA	4 SATA interfaces	8 SATA interfaces	8 SATA interfaces
eSATA	1 eSATA interface		
Capacity	Up to 2TB capacity for each disk		
<b>External interface</b>			
Network interface	1, RJ45 10M / 100M self-adaptive ethernet interface		
Serial interface	1 RS-485 serial interface, 1 RS-485 keyboard interface, 1 RS-232 serial interface		
USB interface	3, USB2.0		
Alarm in	4	16	16
Alarm out	2	4	4
<b>General</b>			
Power supply	100 ~ 240 VAC, 6.3A, 50 ~ 60Hz		
Consumption	≤ 50W (without hard disk or DVD-R/W)		
Working temperature	-10 °C ~ +55 °C		
Working humidity	10% ~ 90%		
Chassis	19-inch rack mounted 2U chassis		
Dimensions (W × D × H)	450 × 450 × 95 mm		
Weight	≤8kg (without hard disk or DVD-R/W)		

# DS-8104/8108/8116HDI-ST Standalone DVR



## Key Features

- H.264 video compression
- Up to 4CIF resolution recording
- HDMI and VGA output at 1920×1080P resolution
- eSATA interface
- 4/8/16-ch synchronous playback
- SADP(IP Finder), FTP, NTP, DHCP protocols



Rear Panel of DS-8116HDI-ST



- |                            |  |
|----------------------------|--|
| 1. Video in                | 10. eSATA interface  |
| 2. Audio in                | 11. LAN interface  |
| 3. Video spot out          | 12. Termination switch                                       |
| 4. Video out               | 13. RS-485 serial interface, seyboard                        |
| 5. Audio out               | 14. RS-485 keyboard interface (for special keyboard control) |
| 6. Line in                 | 15. Interface, alarm in, alarm out                           |
| 7. RS-232 serial interface | 16. GND  |
| 8. VGA interface           | 17. 100-240 VAC power input                                  |
| 9. HDMI interface          | 18. Power switch   |

## Specifications

	DS-8104HDI-ST	DS-8108HDI-ST	DS-8116HDI-ST
<b>Video/Audio input</b>			
Video compression	H.264		
Analog video input	4-ch, BNC (1.0 Vp-p, 75 Ω), PAL/NTSC self-adaptive	8-ch, BNC (1.0 Vp-p, 75 Ω), PAL/NTSC self-adaptive	16-ch, BNC (1.0 Vp-p, 75 Ω), PAL/NTSC self-adaptive
Audio compression	G.711		
Audio input	4-ch, BNC (2.0 Vp-p, 1 kΩ)	8-ch, BNC (2.0 Vp-p, 1 kΩ)	16-ch, BNC (2.0 Vp-p, 1 kΩ)
Voice talk input	1-ch, BNC (2.0 Vp-p, 1 kΩ)		
<b>Video/Audio output</b>			
HDMI output	1-ch, resolution: 1080P:1920×1080 /60 Hz; UXGA: 1600×1200 /60 Hz; SXGA: 1280×1024 /60 Hz; 720P:1280×720 /60 Hz; XGA: 1024×768 /60 Hz.		
VGA output	1-ch, resolution: 1080P:1920×1080 /60 Hz; UXGA: 1600×1200 /60 Hz; SXGA: 1280×1024 /60 Hz; 720P:1280×720 /60 Hz; XGA: 1024×768 /60 Hz.		
CVBS output	2-ch (1 Main Video Out+1 Spot Video Out), BNC (1.0 Vp-p, 75 Ω), resolution: PAL: 704×576, NTSC: 704×480		
Video loop out (optional)	4-ch	8-ch	16-ch
Encoding resolution	4CIF / 2CIF / CIF / QCIF		
Frame rate	Mode1: 4-ch: 4CIF @ 15 fps or 2CIF / CIF / QCIF @ 25 fps (P) / 30 fps (N) Mode2: 1-ch: 4CIF / 2CIF / CIF / QCIF @ 25 fps (P) / 30 fps (N), 3-ch: CIF / QCIF @ 25 fps (P) / 30 fps (N)	Mode1: 8-ch:4CIF @ 12 fps or 2CIF / CIF / QCIF @ 25 fps (P) / 30 fps (N) Mode2: 2-ch: 4CIF / 2CIF / CIF / QCIF @ 25 fps (P) / 30 fps (N), 6-ch: CIF / QCIF @ 25 fps (P) / 30 fps (N)	Mode1: 16-ch: 4CIF @ 12 fps or 2CIF / CIF / QCIF @ 25 fps (P) / 30 fps (N) Mode2: 4-ch: 4CIF / 2CIF / CIF / QCIF @ 25 fps (P) / 30 fps (N), 12-ch: CIF / QCIF @ 25 fps (P) / 30 fps (N)
Video bit rate	32 Kbps ~ 2048 Kbps, or user defined (Max. 3072 Kbps)		
Audio output	2-ch, BNC (Linear, 600Ω)		
Audio bit rate	64 Kbps		
Dual-stream	Support, Sub stream: CIF / QCIF		
Stream type	Video , Video & Audio		
Playback resolution	4CIF / 2CIF / CIF / QCIF		
Synchronous playback	4-ch	8-ch	16-ch
<b>Hard disk</b>			
SATA	4 SATA interfaces	8 SATA interfaces	8 SATA interfaces
eSATA	1 eSATA interface		
Capacity	Up to 4TB capacity for each disk		
<b>External interface</b>			
Network interface	1 RJ45 10M / 100M self-adaptive ethernet interface		
Serial interface	1 RS-232 interface (for parameters configuration, maintenance, transparent channel);1 RS-485 interface (for PTZ control);1 RS-485 keyboard interface (for special keyboard control)		
USB interface	3, USB2.0		
Alarm in	8	8	16
Alarm out	4		
<b>General</b>			
Power supply	100 ~ 240 VAC, 6.3A, 50~60Hz		
Consumption	≤ 25W (without hard disk or DVD-R/W)	≤ 30W (without hard disk or DVD-R/W)	≤ 35W (without hard disk or DVD-R/W)
Working temperature	-10 °C ~ + 55 °C		
Working humidity	10% ~ 90%		
Chassis	19-inch rack-mounted 2 U chassis		
Dimensions (W × D × H)	440 × 450 × 90 mm		
Weight	≤ 8kg (without hard disk or DVD-R/W)		

# DS-8104/8108/8116HFI-ST Standalone DVR



## Key Features

- H.264 video compression
- 4CIF resolution real time recording
- HDMI and VGA output at 1920×1080P resolution
- Dual-stream
- 4/8/16-ch synchronous playback
- SADP(IP Finder), FTP, NTP, DHCP protocols

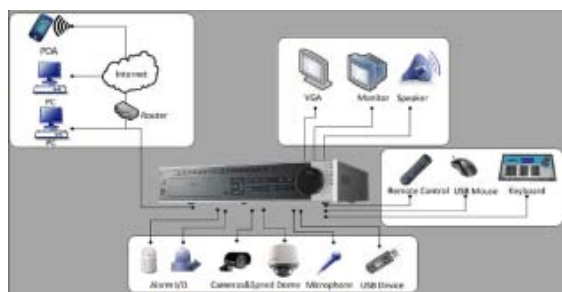

Rear Panel of DS-8116HFI-ST



- |                            |  |
|----------------------------|--|
| 1. Video in                | 10. eSATA interface  |
| 2. Audio in                | 11. LAN interface  |
| 3. Video spot out          | 12. Termination switch   |
| 4. Video out               | 13. RS-485 serial interface, keyboard interface, alarm in, alarm out |
| 5. Audio out               | 14. GND  |
| 6. Line in                 | 15. 100-240 VAC power input  |
| 7. RS-232 serial interface | 16. Power switch   |
| 8. VGA interface           |  |
| 9. HDMI interface          |  |

## Specifications

	DS-8104HFI-ST	DS-8108HFI-ST	DS-8116HFI-ST
<b>Video/Audio input</b>			
Video compression	H.264		
Analog video input	4-ch, BNC(1.0Vp-p, 75 Ω), PAL / NTSC self-adaptive	8-ch, BNC(1.0Vp-p, 75 Ω), PAL / NTSC self-adaptive	16-ch, BNC(1.0Vp-p, 75 Ω), PAL / NTSC self-adaptive
Audio compression	OggVorbis		
Audio input	4-ch, BNC (2.0 Vp-p, 1 kΩ)	8-ch, BNC (2.0 Vp-p, 1 kΩ)	16-ch, BNC (2.0 Vp-p, 1 kΩ)
Voice talk input	1-ch, BNC (2.0 Vp-p, 1 kΩ)		
<b>Video/Audio output</b>			
HDMI output	1-ch, resolution: 1920×1080P /60 Hz, 1920×1080P /50 Hz, 1600×1200 /60 Hz, 1280×1024 /60 Hz, 1280×720 /60 Hz, 1024×768 /60 Hz,		
VGA output	1-ch, resolution: 1920×1080P /60 Hz, 1600×1200 /60 Hz, 1280×1024 /60 Hz, 1280×720 /60 Hz, 1024×768 /60 Hz,		
CVBS output	1-ch, BNC (1.0 Vp-p, 75 Ω), resolution: PAL: 704×576, NTSC: 704×480		
Video spot output	1-ch, BNC (1.0 Vp-p, 75 Ω), resolution: PAL: 704×576, NTSC: 704×480		
Video loop out	Optional		
Encoding resolution	4CIF/ 2CIF / CIF / QCIF		
Frame rate	25 fps (P) /30 fps (N)		
Video bit rate	32 Kbps-2048 Kbps, or user defined (Max. 8192 Kbps)		
Audio output	2-ch, BNC (Linear, 600Ω)		
Audio bit rate	16 Kbps		
Dual-stream	Support		
Stream type	Video, Video & Audio		
Playback resolution	4CIF / 2CIF / CIF / QCIF		
Synchronous playback	4-ch	8-ch	16-ch
<b>Hard disk</b>			
SATA	8 SATA interfaces		
eSATA	1 eSATA interface		
Capacity	Up to 4TB capacity for each disk		
<b>External interface</b>			
Network interface	1 RJ45 10M / 100M / 1000M self-adaptive ethernet interface		
Serial interface	1 RS-232 interface (for parameters configuration, maintenance, transparent channel); 1 RS-485 interface (for PTZ control); 1 RS-485 keyboard interface (for special keyboard control)		
USB interface	2, USB2.0		
Alarm in	4	16	16
Alarm out	2	4	4
<b>General</b>			
Power supply	100-240 VAC, 6.3A, 50-60Hz		
Consumption	≤ 70W (without hard disk or DVD-R/W)		
Working temperature	-10 °C ~ +55 °C		
Working humidity	10%-90%		
Chassis	19-inch rack-mounted 2U chassis		
Dimensions (W × D × H)	445 × 470 × 90 mm		
Weight	≤ 8kg (without hard disk or DVD-R/W)		

# DS-8104/8108/8116HWI-ST Standalone DVR



## Key Features

- H.264 video compression
- WD1(PAL: 960×576, NTSC: 960×480 ) resolution real time recording
- VGA and HDMI output at 1920×1080P resolution
- eSATA interface
- Dual-stream
- 4/8/16-ch synchronous playback

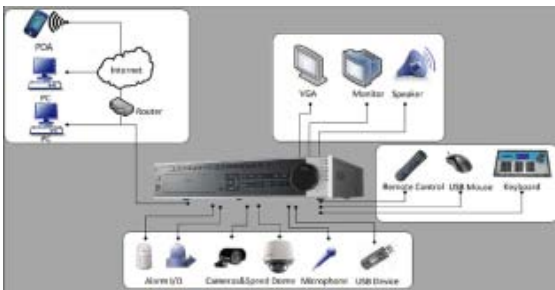

Rear Panel of DS-8116HWI-ST



- |                            |  |
|----------------------------|--|
| 1. Video in                | 10. eSATA interface  |
| 2. Audio in                | 11. LAN interface  |
| 3. Video spot out          | 12. Termination switch   |
| 4. Video out               | 13. RS-485 serial interface, keyboard interface, alarm in, alarm out |
| 5. Audio out               | 14. GND  |
| 6. Line in                 | 15. 100-240 VAC power input  |
| 7. RS-232 serial interface | 16. Power switch   |
| 8. VGA interface           |  |
| 9. HDMI interface          |  |

## Specifications

	DS-8104HWI-ST	DS-8108HWI-ST	DS-8116HWI-ST
<b>Video/Audio input</b>			
Video compression	H.264		
Analog video input	4-ch, BNC(1.0Vp-p, 75 Ω), PAL/NTSC self-adaptive	8-ch, BNC(1.0Vp-p, 75 Ω), PAL/NTSC self-adaptive	16-ch, BNC(1.0Vp-p, 75 Ω), PAL/NTSC self-adaptive
Audio compression	OggVorbis		
Audio input	4-ch, BNC (2.0 Vp-p, 1 kΩ)	8-ch, BNC (2.0 Vp-p, 1 kΩ)	16-ch, BNC (2.0 Vp-p, 1 kΩ)
Voice talk input	1-ch, BNC (2.0 Vp-p, 1 kΩ)		
<b>Video/Audio output</b>			
HDMI/ VGA output	1-ch, resolution: 1024×768 /60 Hz, 1280×720 /60 Hz, 1280×1024 /60 Hz, 1600×1200 /60 Hz, 1920×1080P /60 Hz		
CVBS output	1-ch, BNC (1.0 Vp-p, 75 Ω), resolution: PAL: 704×576, NTSC: 704×480		
Video spot output	1-ch, BNC (1.0 Vp-p, 75 Ω), resolution: PAL: 704×576, NTSC: 704×480		
Video loop out	Optional		
Encoding resolution	WD1 / 2CIF / CIF / QCIF		
Frame rate	25fps (P) / 30fps (N)		
Video bit rate	32 Kbps ~ 2048 Kbps, or user defined (max. 8196 Kbps)		
Audio output	2-ch, BNC (Linear, 600 Ω)		
Audio bit rate	16 Kbps		
Dual-stream	Support		
Stream type	Video, Video & Audio		
Playback resolution	WD1 / 2CIF / CIF / QCIF		
Synchronous playback	4-ch	8-ch	16-ch
<b>Hard disk</b>			
SATA	8 SATA interfaces		
eSATA	1 eSATA interface		
Capacity	Up to 4TB capacity for each disk		
<b>External interface</b>			
Network interface	1 RJ45 10M / 100M / 1000M self-adaptive ethernet interface		
Serial interface	1 RS-232 interface (for parameters configuration, maintenance, transparent channel); 1 RS-485 interface (for PTZ control); 1 RS-485 keyboard interface (for special keyboard control)		
USB interface	2, USB2.0		
Alarm in	4	16	16
Alarm out	2	4	4
<b>General</b>			
Power supply	220 VAC, 6.3A, 47-63Hz		
Consumption	≤ 70W (without hard disk or DVD-R/W)		
Working temperature	-10 °C ~ +55 °C		
Working humidity	10% ~ 90%		
Chassis	19-inch rack-mounted 2U chassis		
Dimensions (W × D × H)	445 × 470 × 90 mm		
Weight	≤ 8Kg (without hard disk or DVD-R/W)		

# DS-7304/7308/7316HI-ST Standalone DVR

## Specifications

	DS-7304HI-ST	DS-7308HI-ST	DS-7316HI-ST
<b>Video/Audio input</b>			
Video compression	H.264		
Analog video input	4-ch, BNC (1.0 Vp-p, 75 Ω), PAL / NTSC self-adaptive	8-ch, BNC (1.0 Vp-p, 75 Ω), PAL / NTSC self-adaptive	16-ch, BNC (1.0 Vp-p, 75 Ω), PAL / NTSC self-adaptive
Audio compression	G.711		
Audio input	4-ch, RCA (2.0 Vp-p, 1 kΩ)		
Voice talk input	1-ch, RCA (2.0 Vp-p, 1 kΩ)		
<b>Video/Audio output</b>			
HDMI output (with HDMI audio output)	1-ch, resolution: 1080P:1920×1080 /60 Hz; UXGA: 1600×1200 /60 Hz; SXGA: 1280×1024 /60 Hz; 720P:1280×720 /60 Hz; XGA: 1024×768 /60 Hz.		
VGA output	1-ch, resolution: 1080P:1920×1080 /60 Hz; UXGA: 1600×1200/60Hz; SXGA: 1280×1024 /60 Hz; 720P:1280×720 /60 Hz; XGA: 1024×768 /60 Hz.		
CVBS output	2-ch (1 Main Video Out+1 Spot Video Out), BNC (1.0 Vp-p, 75 Ω), resolution: PAL: 704×576, NTSC: 704×480		
Video loop out (optional)	4-ch	8-ch	16-ch
Encoding resolution	4CIF / 2CIF / CIF / QCIF		
Frame rate	Mode1: 4CIF @ 15 fps or 2CIF / CIF / QCIF @ 25 fps (P) / 30 fps (N) Mode2: 1-ch: 4CIF / 2CIF / CIF / QCIF @ 25 fps (P) / 30 fps (N), 3-ch: CIF / QCIF @ 25 fps (P) / 30 fps (N)	Mode1: 4CIF @ 12 fps or 2CIF / CIF / QCIF @ 25 fps (P) / 30 fps (N) Mode2: 2-ch: 4CIF / 2CIF / CIF / QCIF @ 25 fps (P) / 30 fps (N), 6-ch: CIF / QCIF @ 25 fps (P) / 30 fps (N)	Mode1: 4CIF @ 12 fps or 2CIF / CIF / QCIF @ 25 fps (P) / 30 fps (N) Mode2: 4-ch: 4CIF / 2CIF / CIF / QCIF @ 25 fps (P) / 30 fps (N), 12-ch: CIF / QCIF @ 25 fps (P) / 30 fps (N)
Video bit rate	32 Kbps ~ 2048 Kbps, or user defined (Max. 3072 Kbps)		
Audio output	2-ch, RCA (Linear, 600 Ω)		
Audio bit rate	64 Kbps		
Dual-stream	Support Sub stream: CIF / QCIF		
Stream type	Video, Video & Audio		
Playback resolution	4CIF / 2CIF / CIF / QCIF		
Synchronous playback	4-ch	8-ch	16-ch
<b>Hard disk</b>			
SATA	4 SATA interfaces		
eSATA	1 eSATA interface		
Capacity	Up to 4TB capacity for each disk		
<b>External interface</b>			
Network interface	1, RJ45 10M / 100M self-adaptive ethernet interface		
Serial interface	1 RS-232 interface (for parameters configuration, maintenance, transparent channel);1 RS-485 interface (for PTZ control);1 RS-485 keyboard interface (for special keyboard control)		
USB interface	3, USB2.0		
Alarm in	8	8	16
Alarm out	4	4	4
<b>General</b>			
Power supply	100 ~ 240 VAC, 5A, 50~60Hz		
Consumption	≤ 25W (without hard disk or DVD-R/W)	≤ 30W (without hard disk or DVD-R/W)	≤ 35W (without hard disk or DVD-R/W)
Working temperature	-10 °C ~ +55 °C		
Working humidity	10% ~ 90%		
Chassis	19-inch rack-mounted 1.5 U chassis		
Dimensions (W x D x H)	440 × 390 × 70 mm		
Weight	≤ 8kg (without hard disk or DVD-R/W)		



## Key Features

- H.264 video compression
- HDMI and VGA output at 1920×1080P resolution
- Smart searching for motion event
- eSATA interface
- 4/8/16-ch synchronous playback
- SADP(IP Finder), SMTP, IPv6, SNMP, FTP, NFS, NDP , iSCSI protocols



Rear Panel of DS-7316HI-ST

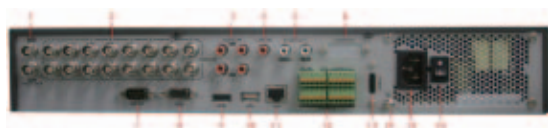

1. Main video out, spot video out
2. Video in
3. Audio in
4. Line in
5. CVBS audio out, vga audio out
6. Loop out
7. RS-232 interface
8. VGA
9. HDMI
10. USB
11. LAN interface
12. RS-485 serial interface, keyboard interface, alarm in, alarm out
13. eSATA interface
14. GND
15. 100-240 VAC power input
16. Power switch

# DS-7304/7308/7316HFI-ST Standalone DVR

## Specifications

	DS-7304HFI-ST	DS-7308HFI-ST	DS-7316HFI-ST
<b>Video/Audio input</b>			
Video compression	H.264		
Analog video input	4-ch, BNC (1.0 Vp-p, 75 Ω), PAL / NTSC self-adaptive	8-ch, BNC (1.0 Vp-p, 75 Ω), PAL / NTSC self-adaptive	16-ch, BNC (1.0 Vp-p, 75 Ω), PAL / NTSC self-adaptive
Audio compression	G.711		
Audio input	4-ch, RCA (2.0 Vp-p, 1 kΩ)		
Voice talk input	1-ch, RCA (2.0 Vp-p, 1 kΩ)		
<b>Video/Audio output</b>			
HDMI output (with HDMI audio output)	1-ch, resolution: 1080P:1920×1080 /60 Hz; UXGA: 1600×1200 /60 Hz; SXGA: 1280×1024 /60 Hz; 720P:1280×720 /60 Hz; XGA: 1024×768 /60 Hz.		
VGA output	1-ch, resolution: 1080P:1920×1080 /60 Hz; UXGA: 1600×1200 /60Hz; SXGA: 1280×1024 /60 Hz; 720P:1280×720 /60 Hz; XGA: 1024×768 /60 Hz.		
CVBS output	2-ch (1 Main Video Out+1 Spot Video Out), BNC (1.0 Vp-p, 75 Ω), resolution: PAL: 704×576, NTSC: 704×480		
Video loop out (optional)	4-ch	8-ch	16-ch
Encoding resolution	4CIF / 2CIF / CIF / QCIF		
Frame rate	25 fps (P) / 30 fps (N)		
Video bit rate	32 Kbps ~ 2048 Kbps, or user defined (max. 3072 Kbps)		
Audio output	2-ch, RCA (linear, 600Ω)		
Audio bit rate	64 Kbps		
Dual-stream	Support, Sub stream: CIF / QCIF		
Stream type	Video, Video & Audio		
Playback resolution	4CIF / 2CIF / CIF / QCIF		
Synchronous playback	4-ch	8-ch	16-ch
<b>Hard disk</b>			
SATA	4 SATA interfaces		
eSATA	1 eSATA interface		
Capacity	Up to 4TB capacity for each disk		
<b>External interface</b>			
Network interface	1 ,RJ45 10M / 100M self-adaptive ethernet interface		
Serial interface	1 RS-232 interface (for parameters configuration, maintenance, transparent channel); 1 RS-485 interface (for PTZ control); 1 RS-485 keyboard interface (for special keyboard control)		
USB interface	3, USB2.0		
Alarm in	8	8	16
Alarm out	4		
<b>General</b>			
Power supply	100 ~ 240 VAC, 5A, 50-60Hz		
Consumption	≤ 25W (without hard disk or DVD-R/W)	≤ 30W (without hard disk or DVD-R/W)	≤ 35W (without hard disk or DVD-R/W)
Working temperature	-10 °C ~ + 55 °C		
Working humidity	10% ~ 90%		
Chassis	19-inch rack-mounted 1.5 U chassis		
Dimensions(W x D x H)	440 × 390 × 70 mm		
Weight	≤ 8kg (without hard disk or DVD-R/W)		



## Key Features

- H.264 video compression
- 4CIF resolution real time recording
- HDMI and VGA output at 1920×1080P resolution
- eSATA interface
- 4/8/16-ch synchronous playback
- SADP(IP Finder), SMTP, SNMP, FTP, NFS, NDP protocols



Rear Panel of DS-7304HFI-ST

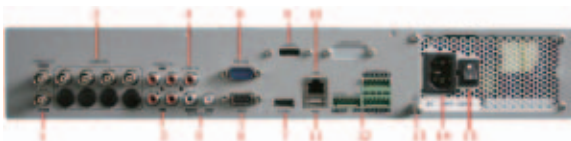

1. Main video out, Spot video out
2. Video in
3. Audio in
4. LINE in
5. CVBS audio out, VGA audio out
6. VGA
7. HDMI
8. RS-232 interface
9. eSATA
10. LAN interface
11. USB
12. RS-485 interface, controller port  
alarm in, alarm out
13. GND
14. 100~240 VAC power input
15. Power switch



# DS-7204/7208/7216HVI-ST Standalone DVR



DS-7216HVI-ST



DS-7204HVI-ST



DS-7208HVI-ST

## Key Features

- H.264 video compression
- Up to 4CIF resolution recording
- VGA output at 1280 × 1024 resolution
- 4/8/16-ch synchronous playback
- Dual-stream
- SADP(IP Finder), NTP, DHCP, SMTP protocols



Rear Panel of DS-7216HVI-ST

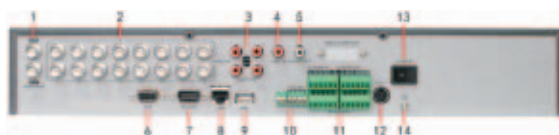

- |                            |                                   |
|----------------------------|-----------------------------------|
| 1. Main / spot video out   | 8. LAN                            |
| 2. Video in                | 9. USB interface                  |
| 3. Audio in                | 10. RS-485 interface              |
| 4. Line in                 | 11. Alarm in, alarm out           |
| 5. Audio out               | 12. 12 VDC power supply interface |
| 6. VGA interface           | 13. Power switch                  |
| 7. RS-232 serial interface | 14. GND                           |

## Specifications

	DS-7204HVI-ST	DS-7208HVI-ST	DS-7216HVI-ST
<b>Video/Audio input</b>			
Video compression	H.264		
Analog video input	4-ch	8-ch	16-ch
Video interface	BNC connector (1.0 Vp-p, 75 Ω); PAL / NTSC self-adaptive		
Audio compression	G.711		
Audio input	4-ch, RCA connector (2.0 Vp-p, 1 kΩ)		
Voice talk input	1-ch, RCA (2.0 Vp-p, 1 kΩ)		
VGA output	1-ch, resolution: 1280 × 1024 /60 Hz, 1024 × 768 /60 Hz		
CVBS output	2-ch, BNC connector (1.0 Vp-p, 75 Ω); Resolution: PAL: 704 × 576, NTSC: 704 × 480		
Audio output	1-ch, RCA connector (linear, 1 kΩ)		
<b>Video/Audio output</b>			
Recording resolution	4CIF / 2CIF / CIF		
Frame rate	Main stream: 4CIF / 2CIF: 12 fps	Main stream: 4CIF / 2CIF: 8 fps	Main stream: 4CIF / 2CIF: 6 fps
	Sub stream: CIF / QCIF		
Video bit rate	32 kbps ~ 2048 kbps, or user defined (max. 3072 kbps)		
Stream type	Video, Video & Audio		
Audio bit rate	64 kbps		
Dual-stream	Support		
Synchronous playback	4-ch	8-ch	16-ch
<b>Hard disk</b>			
SATA	1 SATA interface	2 SATA interfaces	2 SATA interfaces
Capacity	Up to 2TB capacity for each disk		
<b>External interface</b>			
Network interface	1 ,RJ45 10M / 100M self-adaptive ethernet interface		
Serial interface	1 RS-485 interface, 1 RS-232 interface		
USB interface	2, USB 2.0		
Alarm in	4	8	16
Alarm out	1	4	4
<b>General</b>			
Power supply	12 VDC		
Consumption	≤ 10W (without hard disk or DVD-R/W)	≤ 10W (without hard disk or DVD-R/W)	≤ 15W (without hard disk or DVD-R/W)
Working temperature	-10°C ~ +55°C		
Working humidity	10% ~ 90%		
Chassis	Stand-alone 1U chassis	19-inch standard rack-mounted 1U chassis	19-inch standard rack-mounted 1.5U chassis
Dimensions (W x D x H)	315 × 230 × 45 mm	445 × 290 × 45 mm	445 × 390 × 70 mm
Weight	≤ 2kg (without hard disk or DVD-R/W)	≤ 4kg (without hard disk or DVD-R/W)	≤ 8kg (without hard disk or DVD-R/W)

# DS-7204/7208/7216HVI-ST/SE Standalone DVR



DS-7216HVI-ST/SE



DS-7204HVI-ST/SE



DS-7208HVI-ST/SE

## Key Features

- H.264 video compression
- Up to 4CIF resolution recording
- VGA output at 1280 × 1024 resolution
- Dual-stream
- 4/8/16-ch synchronous playback
- SADP(IP Finder), NTP, DHCP, SMTP protocols



Rear Panel of DS-7216HVI-ST/SE



- |                        |                                  |
|------------------------|----------------------------------|
| 1. USB interface       | 6. LAN                           |
| 2. Video out           | 7. RS-485 interface              |
| 3. Video in            | 8. 12 VDC power supply interface |
| 4. Audio in, audio out | 9. Power switch                  |
| 5. VGA interface       | 10. GND                          |

## Specifications

	DS-7204HVI-ST/SE	DS-7208HVI-ST/SE	DS-7216HVI-ST/SE
<b>Video/Audio input</b>			
Video compression	H.264		
Analog video input	4-ch	8-ch	16-ch
Video interface	BNC connector (1.0 Vp-p, 75 Ω); PAL / NTSC self-adaptive		
Audio compression	G.711		
Audio input	1-ch, RCA connector (2 Vp-p, 1 kΩ)		
Voice talk input	1-ch, RCA (2.0 Vp-p, 1 kΩ)		
<b>Video/Audio output</b>			
Recording resolution	4CIF / 2CIF / CIF		
VGA output	1-ch, resolution: 1280 × 1024 /60 Hz, 1024 × 768 /60 Hz		
CVBS output	1-ch, BNC connector (1.0 Vp-p, 75 Ω); Resolution: PAL: 704 × 576, NTSC: 704 × 480		
Audio output	1-ch, RCA connector (linear, 1 kΩ)		
Frame rate	Main stream: 4CIF / 2CIF@ 12 fps, CIF@25 fps (P) / 30 fps (N)	Main stream: 4CIF / 2CIF@ 8 fps, CIF@25 fps (P) / 30 fps (N)	Main stream: 4CIF / 2CIF@6 fps, CIF@25 fps (P) / 30 fps (N)
	Sub stream: CIF / QCIF		
Video bit rate	32 kbps ~ 2048 kbps, or user defined (max. 3072 kbps)		
Stream type	Video, Video & Audio		
Audio bit rate	64 kbps		
Dual-stream	Support		
Synchronous playback	4-ch	8-ch	16-ch
<b>Hard disk</b>			
SATA	1 SATA interface	1 SATA interface	2 SATA interfaces
Capacity	Up to 2TB capacity for each disk		
<b>External interface</b>			
Network interface	1, RJ45 10 M / 100 M adaptive ethernet interface		
Serial interface	1 RS-485 interface, 1 RS-232 interface		
USB interface	2, USB 2.0		
<b>General</b>			
Power supply	12 VDC		
Consumption	≤ 10W (without hard disk or DVD-R/W)	≤ 10W (without hard disk or DVD-R/W)	≤ 15W (without hard disk or DVD-R/W)
Working temperature	-10 °C ~ +55 °C		
Working humidity	10% ~ 90%		
Chassis	Stand-alone 1U chassis	19-inch standard rack-mounted 1U chassis	19-inch standard rack-mounted 1.5U chassis
Dimensions (W x D x H)	315 × 230 × 45 mm	445 × 290 × 45 mm	445 × 390 × 70 mm
Weight	≤ 2kg (without hard disk or DVD-R/W)	≤ 4kg (without hard disk or DVD-R/W)	≤ 8kg (without hard disk or DVD-R/W)

# DS-7204/7208/7216HVI-ST/SN Standalone DVR



## Key Features

- H.264 video compression
- Up to 4CIF resolution recording
- VGA output at 1280 × 1024 resolution
- Dual-stream
- 4/8/16-ch synchronous playback
- SADP(IP Finder), NTP, DHCP, SMTP protocols

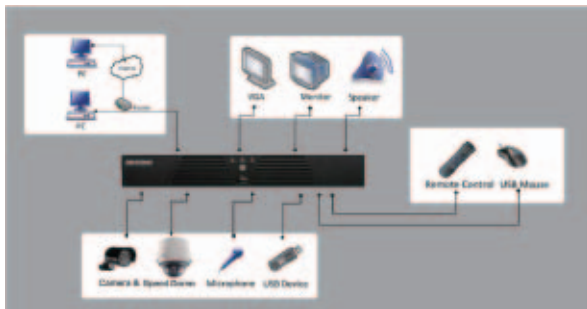

Rear Panel of DS-7216HVI-ST/SN



- |                  |                                  |
|------------------|----------------------------------|
| 1. USB interface | 7. LAN                           |
| 2. Video out     | 8. RS-485 interface              |
| 3. Video in      | 9. 12 VDC power supply interface |
| 4. Audio in      | 10. Power switch                 |
| 5. Audio out     | 11. GND                          |
| 6. VGA interface |                                  |

## Specifications

	DS-7204HVI-ST/SN	DS-7208HVI-ST/SN	DS-7216HVI-ST/SN
<b>Video/Audio input</b>			
Video compression	H.264		
Analog video input	4-ch	8-ch	16-ch
Video input interface	BNC connector (1.0 Vp-p, 75 Ω); PAL / NTSC self-adaptive		
Audio compression	G.711		
Audio input	1-ch, RCA connector (2.0 Vp-p, 1 kΩ)		
Voice talk input	1-ch, RCA (2.0 Vp-p, 1 kΩ) , (Using audio in)		
<b>Video/Audio output</b>			
Recording resolution	4CIF / 2CIF / CIF		
VGA output	1-ch, resolution: 1280 × 1024 /60 Hz, 1024 × 768 /60 Hz		
CVBS output	1-ch, BNC connector (1.0 Vp-p, 75 Ω); Resolution: PAL: 704 × 576, NTSC: 704 × 480		
Audio output	1-ch, RCA connector (linear, 1 kΩ)		
Frame rate	Main stream: 4CIF / 2CIF: 12 fps Sub stream: CIF / QCIF	Main stream: 4CIF / 2CIF: 8 fps	Main stream: 4CIF / 2CIF: 6 fps
Video bit rate	32 kbps ~ 2048 kbps, or user defined (max. 3072 kbps)		
Stream type	Video, Video & Audio		
Audio bit rate	64 kbps		
Dual-stream	Support		
Synchronous playback	4-ch	8-ch	16-ch
<b>Hard disk</b>			
SATA	1 SATA interface		
Capacity	Up to 2TB capacity for each disk		
<b>External interface</b>			
Network interface	1, RJ45 10M / 100M adaptive Ethernet interface		
Serial interface	1 RS-485 interface, 1 RS-232 interface		
USB interface	2, USB 2.0		
<b>General</b>			
Power supply	12 VDC		
Consumption	≤ 10W (without hard disk or DVD-R/W)	≤ 10W (without hard disk or DVD-R/W)	≤ 15W (without hard disk or DVD-R/W)
Working temperature	-10 °C ~ +55 °C		
Working humidity	10% ~ 90%		
Dimensions (W x D x H)	315 × 230 × 45 mm		
Weight	≤ 2kg (without hard disk or DVD-R/W)		

# DS-7204/7208/7216HFI-ST Standalone DVR

## Specifications

	DS-7204HFI-ST	DS-7208HFI-ST	DS-7216HFI-ST
<b>Video/Audio input</b>			
Video compression	H.264		
Analog video input	4-ch	8-ch	16-ch
Video input interface	BNC connector (1.0 Vp-p, 75 Ω); PAL / NTSC self-adaptive		
Audio compression	G.711		
Audio input	4-ch, RCA connector (2.0 Vp-p, 1 kΩ)		
Voice talk input	1-ch, RCA (2.0 Vp-p, 1 kΩ)		
VGA output	1-ch, resolution: 1280 × 1024 /60 Hz, 1024 × 768 /60 Hz		
CVBS output	2-ch, BNC connector (1.0 Vp-p, 75 Ω); Resolution: PAL: 704 × 576, NTSC: 704 × 480		
Audio output	1-ch, RCA connector (linear, 1 kΩ)		
<b>Video/Audio output</b>			
Recording resolution	4CIF / 2CIF / CIF		
Frame rate	Main stream: 4CIF / 2CIF / CIF@25 fps (P) / 30 fps (N) Sub stream: CIF / QCIF		
Video bit rate	32 kbps ~ 2048 kbps, or user defined (max. 3072 kbps)		
Stream type	Video, Video & Audio		
Audio bit rate	64 kbps		
Dual-stream	Support		
Synchronous playback	4-ch	8-ch	16-ch
<b>Hard disk</b>			
SATA	1 SATA interface	2 SATA interfaces	2 SATA interfaces
Capacity	Up to 2TB capacity for each disk		
<b>External interface</b>			
Network interface	1, RJ45 10M / 100M self-adaptive ethernet interface		
Serial interface	1 RS-485 full-duplex interface, 1 RS-232 interface		
USB interface	2, USB 2.0		
Alarm in	4	8	16
Alarm out	1	4	4
<b>General</b>			
Power supply	12 VDC		
Consumption	≤ 10W (without hard disk or DVD-R/W)	≤ 10W (without hard disk or DVD-R/W)	≤ 15W (without hard disk or DVD-R/W)
Working temperature	-10 °C ~ +55 °C		
Working humidity	10% ~ 90%		
Chassis	Stand-alone 1U chassis	19-inch standard rack-mounted 1U chassis	19-inch standard rack-mounted 1U chassis
Dimensions (W x D x H)	315 × 230 × 45 mm	445 × 290 × 45 mm	445 × 290 × 45 mm
Weight	≤ 2kg (without hard disk or DVD-R/W)	≤ 4kg (without hard disk or DVD-R/W)	≤ 4kg (without hard disk or DVD-R/W)



DS-7208/7216HFI-ST



DS-7204HFI-ST

## Key Features

- H.264 video compression
- 4CIF resolution real time recording
- VGA output at 1280 × 1024 resolution
- Dual-stream
- 4/8/16-ch synchronous playback
- SADP(IP Finder),NTP, DHCP,SMTP protocols

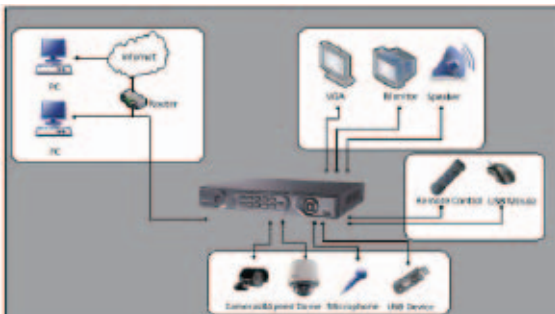

Rear Panel of DS-7216HFI-ST



- |                            |                                   |
|----------------------------|-----------------------------------|
| 1. Main/spot video out     | 8. LAN                            |
| 2. Video in                | 9. USB interface                  |
| 3. Audio in                | 10. RS-485 interface              |
| 4. Line in                 | 11. Alarm in, alarm out           |
| 5. Audio out               | 12. 12 VDC power supply interface |
| 6. VGA interface           | 13. Power switch                  |
| 7. RS-232 serial interface | 14. GND                           |

# DS-7204/7208/7216HFI-ST/SE Standalone DVR



DS-7208/7216HFI-ST/SE



DS-7204HFI-ST/SE

## Key Features

- H.264 video compression
- Up to 4CIF resolution recording
- VGA output at 1280 × 1024 resolution
- Dual-stream
- 4/8/16-ch synchronous playback
- SADP(IP Finder), NTP, DHCP,SMTP protocols

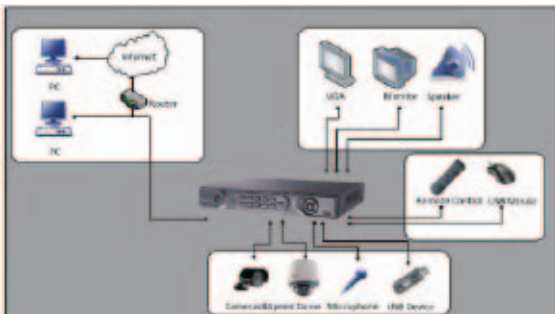

Rear Panel of DS-7216HFI-ST/SE



- |                        |                                  |
|------------------------|----------------------------------|
| 1. USB Interface       | 6. LAN                           |
| 2. Video out           | 7. RS-485 interface              |
| 3. Video in            | 8. 12 VDC power supply interface |
| 4. Audio in, audio out | 9. Power switch                  |
| 5. VGA interface       | 10. GND                          |

## Specifications

	DS-7204HFI-ST/SE	DS-7208HFI-ST/SE	DS-7216HFI-ST/SE
<b>Video/Audio input</b>			
Video compression	H.264		
Analog video input	4-ch	8-ch	16-ch
Video interface	BNC connector (1.0 Vp-p, 75 Ω); PAL / NTSC self-adaptive		
Audio compression	G.711		
Audio input	1-ch,RCA connector (2.0 Vp-p, 1 kΩ)		
Voice talk input	1-ch, RCA (2.0 Vp-p, 1 kΩ)		
<b>Video/Audio output</b>			
Recording resolution	4CIF / 2CIF / CIF		
VGA output	1-ch, resolution: 1280 × 1024 /60 Hz, 1024 × 768 /60 Hz		
CVBS output	1-ch, BNC connector (1.0 Vp-p, 75 Ω); Resolution: PAL: 704 × 576, NTSC: 704 × 480		
Audio output	1-ch, RCA connector (linear, 1 kΩ)		
Frame rate	25 fps (P) / 30 fps (N)		
Video bit rate	32 kbps ~ 2048 kbps, or user defined (max. 3072 kbps)		
Stream type	Video, Video & Audio		
Audio bit rate	64 kbps		
Dual-stream	Support (sub stream at CIF / QCIF)		
Synchronous playback	4-ch	8-ch	16-ch
<b>Hard disk</b>			
SATA	1 SATA interface	2 SATA interfaces	2 SATA interfaces
Capacity	Up to 2TB capacity for each disk		
<b>External interface</b>			
Network interface	1, RJ45 10M / 100M self-adaptive ethernet interface		
Serial interface	1 RS-485 full-duplex interface		
USB interface	2, USB 2.0		
<b>General</b>			
Power supply	12 VDC		
Consumption	≤ 10W (without hard disk or DVD-R/W)	≤ 10W (without hard disk or DVD-R/W)	≤ 15W (without hard disk or DVD-R/W)
Working temperature	-10 °C ~ +55 °C		
Working humidity	10% ~ 90%		
Chassis	Stand-alone 1U chassis	19-inch rack-mounted 1U chassis	19-inch rack-mounted 1U chassis
Dimensions (W x D x H)	315 × 230 × 45 mm	445 × 290 × 45 mm	445 × 290 × 45 mm
Weight	≤ 2kg (without hard disk or DVD-R/W)	≤ 4kg (without hard disk or DVD-R/W)	≤ 4kg (without hard disk or DVD-R/W)

# DS-7204/7208/7216HFI-ST/SN Standalone DVR



DS-7204/7208HFI-ST/SN



DS-7216HFI-ST/SN

## Key Features

- H.264 video compression
- 4CIF resolution real time recording
- VGA output at 1280 × 1024 resolution
- Dual-stream
- 4/8/16-ch synchronous playback
- SADP (IP Finder), NTP, DHCP, SMTP protocols

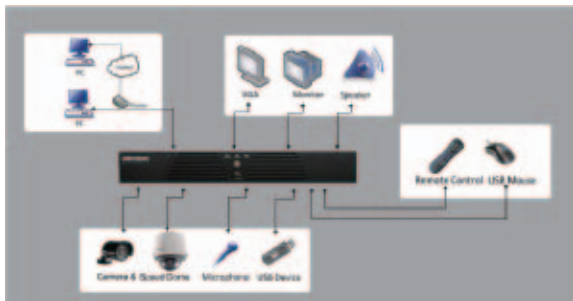

Rear Panel of DS-7208HFI-ST/SN



- |                  |                                  |
|------------------|----------------------------------|
| 1. USB interface | 7. LAN                           |
| 2. Video out     | 8. RS-485 interface              |
| 3. Video in      | 9. 12 VDC power supply interface |
| 4. Audio in      | 10. Power switch                 |
| 5. Audio out     | 11. GND                          |
| 6. VGA interface |                                  |

## Specifications

	DS-7204HFI-ST/SN	DS-7208HFI-ST/SN	DS-7216HFI-ST/SN
<b>Video/Audio input</b>			
Video compression	H.264		
Analog video input	4-ch	8-ch	16-ch
Video input interface	BNC connector (1.0 Vp-p, 75 Ω); PAL / NTSC self-adaptive		
Audio compression	G.711		
Audio input	1-ch, RCA connector (2.0 Vp-p, 1 kΩ)		
Voice talk input	1-ch, RCA (2.0 Vp-p, 1 kΩ), (using audio in)		
VGA output	1-ch, resolution: 1280 × 1024 /60 Hz, 1024 × 768 /60 Hz		
CVBS output	1-ch, BNC connector (1.0 Vp-p, 75 Ω); Resolution: PAL: 704 × 576, NTSC: 704 × 480		
Audio output	1-ch, RCA connector (linear, 1 kΩ)		
<b>Video/Audio output</b>			
Recording resolution	4CIF / 2CIF / CIF		
Frame rate	25 fps (P) / 30 fps (N)		
Video bit rate	32 kbps ~ 2048 kbps, or user defined (max. 3072 kbps)		
Stream type	Video, Video & Audio		
Audio bit rate	64 kbps		
Dual-stream	Support		
Synchronous playback	4-ch	8-ch	16-ch
<b>Hard disk</b>			
SATA	1 SATA interface	1 SATA interface	2 SATA interfaces
Capacity	Up to 2TB capacity for each disk		
<b>External interface</b>			
Network interface	1, RJ45 10M / 100M self-adaptive ethernet interface		
Serial interface	1 RS-485 half-duplex interface		
USB interface	2, USB 2.0		
<b>General</b>			
Power supply	12 VDC		
Consumption	≤ 10W (without hard disk or DVD-R/W)	≤ 10W (without hard disk or DVD-R/W)	≤ 15W (without hard disk or DVD-R/W)
Working temperature	-10 °C ~ +55 °C		
Working humidity	10% ~ 90%		
Chassis	Stand-alone 1U chassis	Stand-alone 1U chassis	19-inch rack-mounted 1U chassis
Dimensions (W x D x H)	315 × 230 × 45 mm	315 × 230 × 45 mm	445 × 290 × 45 mm
Weight	≤ 2kg (without hard disk or DVD-R/W)	≤ 2kg (without hard disk or DVD-R/W)	≤ 4kg (without hard disk or DVD-R/W)

# DS-7204HVI-ST/L Standalone DVR



## Key Features

- H.264 video compression
- Up to 4CIF resolution recording
- VGA output at 1280 × 1024 resolution
- 5 inch LCD display
- 4-ch synchronous playback
- Dual-stream
- SADP(IP Finder), NTP, DHCP, SMTP protocols



Rear Panel of DS-7204HVI-ST/L



- |                        |   |
|------------------------|---|
| 01, Video in           | 07, RS-485 interface, alarm in, alarm out |
| 02, Video out          | 08, VGA interface                         |
| 03, Audio in           | 09, RS-232 serial interface               |
| 04, Line in, audio out | 10, 12 VDC power supply interface         |
| 05, LAN                | 11, Power switch                          |
| 06, USB interface      |   |

## Specifications

DS-7204HVI-ST/L	
<b>Video/Audio input</b>	
Video compression	H.264
Analog video input	4-ch, BNC connector (1.0 Vp-p, 75 Ω); PAL / NTSC self-adaptive
Audio compression	G.711
Audio input	4-ch, RCA connector (2.0 Vp-p, 1 kΩ)
<b>Video/Audio output</b>	
VGA output	1-ch, resolution: 1280 × 1024 /60 Hz
CVBS output	2-ch, BNC connector (1.0 Vp-p,75 Ω); Resolution: PAL: 704 × 576, NTSC: 704 × 480
Audio output	1-ch, RCA connector (linear, 1 kΩ)
Recording resolution	4CIF / 2CIF / CIF
Frame rate	Main stream: 4CIF / 2CIF@ 12 fps, CIF@25 fps (P) / 30 fps (N) Sub stream: CIF / QCIF
Video bit rate	32 kbps ~ 2048 kbps, or user defined (max. 3072 kbps)
Stream type	Video , Video & Audio
Audio bit rate	64 kbps
Dual-stream	Support
Synchronous playback	4-ch
Voice talk input	1-ch RCA (2.0 Vp-p, 1 kΩ)
<b>Hard disk</b>	
SATA	1 SATA interface
Capacity	Up to 2TB capacity
<b>External interface</b>	
Network interface	1, RJ45 10 M / 100 M self-adaptive ethernet interface
Serial interface	1 RS-485 interface, 1 RS-232 interface
USB interface	2, USB 2.0
Alarm in	4
Alarm out	1
<b>General</b>	
Power supply	12 VDC
Consumption	≤ 10W (without hard disk or DVD-R/W)
Working temperature	-10 °C ~ +55 °C
Working humidity	10% ~ 90%
Chassis	Chassis for ATM DVR
Dimensions (W x D x H)	180 × 280 ×180 mm
Weight	≤5kg (without hard disk or DVD-R/W)

# DS-9604/9608/9612/9616NI-SH Embedded NVR



## Specifications

	DS-9604NI-SH	DS-9608NI-SH	DS-9612NI-SH	DS-9616NI-SH
<b>Video/Audio input</b>				
IP Video input	4-ch 4CIF/ 2-ch 720P/ 1-ch UXGA/1080P Real Time, or 2-ch UXGA/1080P not Real Time	8-ch 4CIF/ 4-ch 720P/ 2-ch UXGA/1080P Real Time, or 4-ch UXGA/1080P not Real Time	12-ch 4CIF/ 6-ch 720P/ 3-ch UXGA/1080P Real Time, or 6-ch UXGA/1080P not Real Time	16-ch 4CIF/ 8-ch 720P/ 4-ch UXGA/1080P Real Time, or 8-ch UXGA/1080P not Real Time
Audio input	2-ch, BNC(2.0 Vp-p, 1 kΩ)			
<b>Video/Audio output</b>				
CVBS output	2-ch, BNC(1.0 Vp-p, 75 Ω), Resolution: 704×576(PAL); 704×480(NTSC)			
HDMI output	1-ch, resolution: 1024×768 /60 Hz, 1280×1024 /60 Hz, 1920×1080 /60 Hz			
VGA output	1-ch, resolution: 1024×768 /60 Hz, 1024×768 /70 Hz, 1280×1024 /60 Hz			
Audio output	2-ch, BNC(linear electrical level, 600 Ω)			
Synchronous playback	4-ch	8-ch	12-ch	16-ch
<b>Hard disk</b>				
SATA	8 SATA interfaces			
Capacity	Up to 2TB capacity for each disk			
<b>External interface</b>				
Voice talk	2-ch, BNC(2.0 Vp-p, 1 kΩ)			
Network interface	1, RJ-45, 10/100/1000Mbps self-adaptive ethernet interface			
Serial interface	1 RS-232 interface (for parameters configuration, maintenance , transparent channel);1 RS-485 interface (for PTZ control);1 RS-485 keyboard interface (for special keyboard control)			
USB interface	3, USB2.0			
Alarm in	16			
Alarm out	4			
<b>General</b>				
Power supply	100~240 VAC, 6.3A, 50~60Hz			
Consumption	≤ 70W (without hard disk or DVD-R/W)			
Working temperature	-10 °C ~ +55 °C			
Working humidity	10%~90%			
Dimensions (W x D x H)	450 x 450 x 95mm			
Weight	≤ 8kg ( without hard disk or DVD-R/W )			

## Key Features

- Third-party network cameras supported
- HDMI output at 1920×1080 resolution
- 4/8/12/16-ch synchronous playback
- 8 SATA interfaces
- HDD group management

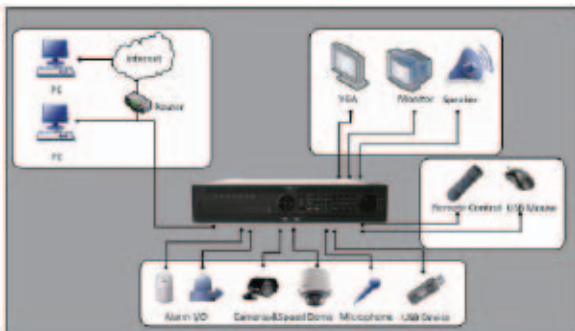

Rear Panel of DS-9600NI-SH



1. Video out (spot), audio out (spot)
2. Video out, audio out
3. Line in
4. VGA output
5. RS-232 serial interface
6. HDMI output
7. eSATA backup / extended storage interface (optional)
8. LAN (10/100/1000Mbps Self-adaptive UTP ethernet interface)
9. USB interface
10. RS-485 matched resistance switch
11. RS-485 serial interface, rs485 keyboard port, alarm in, alarm out
12. GND
13. 100~240 VAC power input



# DS-9508/9516NI-S Embedded NVR

## Specifications

	DS-9508NI-S	DS-9516NI-S
<b>Video/Audio input</b>		
IP Video input	8-ch 4CIF/4-ch 720P/2-ch UXGA realtime, or 4-ch UXGA/2-ch 5 Megapixels not real time	16-ch 4CIF/8-ch 720P/4-ch UXGA real time, or 8-ch UXGA/4-ch 5 Megapixels not real time
<b>Hard disk</b>		
Type	8 SATA interfaces	
Capacity	Up to 2TB capacity for each disk	
<b>External interface</b>		
Network interface	1,RJ-45, 10/100/1000Mbps self-adaptive Ethernet interface	
Serial interface	1 RS-232 interface (for parameters configuration, maintenance , transparent channel);1 RS-485 interface (for PTZ control);1 RS-485 keyboard interface (for special keyboard control)	
USB interface	2, USB2.0	
Alarm in	16	
Alarm out	4	
<b>General</b>		
Power supply	100~240 VAC, 6.3A, 50~60Hz	
Consumption	≤20W (without hard disk or DVD-R/W)	
Working temperature	-10 °C ~ +55 °C	
Working humidity	10%~90%	
Chassis	19-inch rack-mounted 2U chassis	
Dimensions (W x D x H)	450 × 470 ×90 mm	
Weight	≤ 8kg ( without hard disk or DVD-R/W )	



## Key Features

- Third-party network cameras supported
- Up to 5 Megapixels (2560×1920) recording resolution.
- 8 SATA interfaces
- One button archive
- HDD group management



Rear Panel of DS-9516NI-S

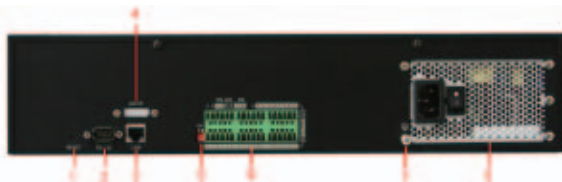

1. Reset
2. RS-232 serial interface
3. LAN (10/100/1000Mbps self-adaptive utp ethernet interface)
4. eSATA backup/extended Storage interface(optional)
5. RS-485 matched resistance switch
6. RS-485 serial interface, alarm in, alarm out
7. GND
8. 100~240 VAC power input

# DS-7604NI-S Embedded NVR



## Key Features

- H.264/MPEG-4 video stream input
- Up to 5 Megapixels (2560×1920) resolution recording
- VGA output at 1024×768 resolution
- 4x digital zoom capability
- 4-ch synchronous playback

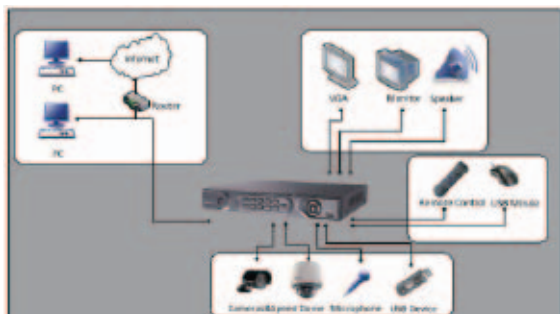

Rear Panel of DS-7604 NI-S

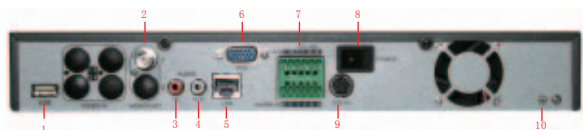

- |                  |  |
|------------------|--|
| 1. USB interface | 7. RS-485 interface, alarm in, alarm out |
| 2. Video out     | 8. Power switch                          |
| 3. Audio in      | 9. 12 VDC power supply                   |
| 4. Audio out     | 10. GND                                  |
| 5. LAN           |  |
| 6. VGA interface |  |

## Specifications

DS-7604NI-S	
<b>Video/Audio input</b>	
IP Video input	4-ch 4CIF real time or 2-ch 720P / UXGA / 1080P real time or 1-ch 2560×1920 not real time
Audio input	1-ch, RCA(2.0 Vp-p, 1 kΩ), for voice talk input
<b>Video/Audio output</b>	
Live view resolution	PAL:704×576, NTSC:704×480
VGA output	1-ch, resolution:1024×768 /60 Hz
Playback resolution	2560×1920/ UXGA / 1080P / 720P / 4CIF / VGA / DCIF / 2CIF/ CIF / QCIF
Video output	1-ch, BNC (PAL: 704×576, NTSC: 704×480)
Frame rate	25fps (P) / 30fps (N)
Video bit rate	32 Kbps~2048 Kbps, or user defined (max. 16384 Kbps)
Audio output	1-ch, RCA(2.0 Vp-p, 1 kΩ), for voice talk output
Audio bit rate	16kbps
Synchronous playback	4-ch
<b>Hard disk</b>	
SATA	1 SATA interface
Capacity	Up to 2TB capacity for each disk
<b>External interface</b>	
Network interface	1, RJ45 10M / 100M self-adaptive ethernet interface
Serial interface	1 RS-485 interface
USB interface	2, USB2.0
Alarm in	4
Alarm out	1
<b>General</b>	
Power supply	12 VDC
Consumption	≤ 12W (without hard disk or DVD-R/W)
Working temperature	-10 °C ~ +55 °C
Working humidity	10%~90%
Dimensions (W x D x H)	315 × 230 ×45 mm
Weight	≤ 2.5kg (without HDD or DVD-R/W)

# DS-7608NI-S Embedded NVR



## Key Features

- H.264/MPEG-4 video stream input
- Up to 5 Megapixels (2560×1920) resolution
- VGA output at 1024×768 resolution
- 4-ch synchronous playback
- HDD group management
- 2 SATA interfaces

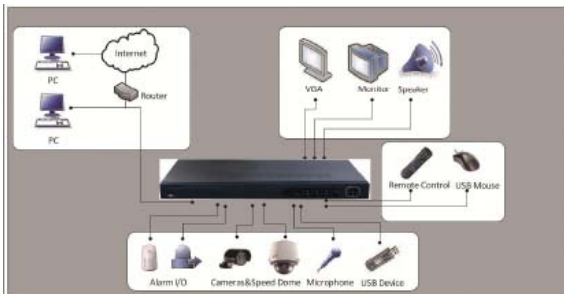

## Specifications

DS-7608NI-S	
<b>Video/Audio input</b>	
IP Video input	8-ch 4CIF real time or 4-ch 720P / UXGA / 1080P real time or 2-ch 2560×1920 not real time
Audio input	1-ch, RCA(2.0 Vp-p, 1 kΩ), for voice talk input
<b>Video/Audio output</b>	
VGA output	1-ch, resolution: 1024×768 /60 Hz
Playback resolution	2560×1920 / UXGA / 1080P / 720P / 4CIF / VGA / DCIF / 2CIF / CIF / QCIF
Video output	1-ch, BNC (PAL: 704×576, NTSC: 704×480)
Frame rate	25fps (P) / 30fps (N)
Video bit rate	32Kbps~2048Kbps, or user defined (max. 16384 Kbps)
Audio output	1-ch, RCA(2.0 Vp-p, 1 kΩ), for voice talk output
Audio bit rate	16kbps
Synchronous playback	4-ch
<b>Hard disk</b>	
SATA	2 SATA interfaces
Capacity	Up to 2TB capacity for each disk
<b>External interface</b>	
Network interface	1, RJ45 10M / 100M self-adaptive ethernet interface
Serial interface	1 RS-485 interface
USB interface	2, USB2.0
Alarm in	4
Alarm out	1
<b>General</b>	
Power supply	12 VDC
Consumption	≤ 12W (without hard disk or DVD-R/W)
Working temperature	-10 °C ~ +55 °C
Working humidity	10%~90%
Dimensions (W x D x H)	445 × 290 × 44 mm
Weight	≤ 8kg (without HDD or DVD-R/W)

Rear Panel of DS-7608NI-S



- |                  |  |
|------------------|--|
| 1. USB interface | 6. VGA interface                         |
| 2. Video out     | 7. RS-485 interface, alarm in, alarm out |
| 3. Audio in      | 8. 12 VDC power supply                   |
| 4. Audio out     | 9. GND                                   |
| 5. LAN           | 10. Power switch                         |

# DS-8104/8108AH(L)I-ST ATM DVR



## Key Features

- H.264 video compression
- VGA output at 1280×1024 resolution
- Up to 4CIF resolution recording
- Dual-stream
- 4 SATA interfaces
- HDD group management

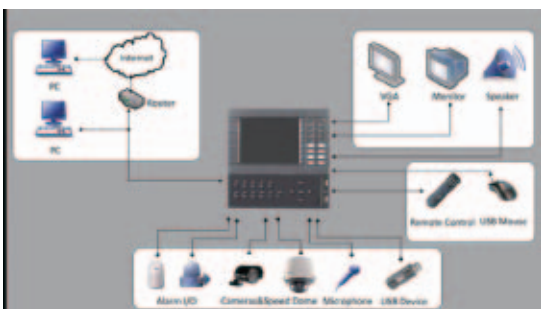

Rear Panel of DS-8108AH(L)I-ST



1. Video in
2. Audio in
3. Video out, audio out, line in
4. RS-232 interface
5. VGA
6. LAN interface
7. eSATA interface
8. RS-485 interface
9. Alarm in, alarm out
10. 12 VDC power output for camera
11. Power switch
12. GND

## Specifications

	DS-8104AH(L)I-ST	DS-8108AH(L)I-ST
<b>Video/Audio input</b>		
Video compression	H.264	
Analog video input	4-ch, BNC (1.0 Vp-p, 75 Ω) PAL / NTSC self-adaptive	8-ch, BNC (1.0 Vp-p, 75 Ω) PAL / NTSC self-adaptive
Audio compression	OggVorbis	
Audio input	4-ch, BNC (2.0 Vp-p, 1 kΩ)	8-ch, BNC (2.0 Vp-p, 1 kΩ)
Voice talk input	1-ch, BNC (2.0 Vp-p, 1 kΩ)	
<b>Video/Audio output</b>		
Preview resolution	PAL: 704 × 576, NTSC: 704 × 480	
CVBS output	1, BNC (1.0 Vp-p, 75 Ω), Resolution: PAL: 704 × 576, NTSC: 704 × 480	
VGA output	1, Resolution: 1024 × 768 /60 Hz	
LCD display	Available on DS-8104AHLI-ST and DS-8108AHLI-ST models	
Encoding resolution	Channel 1: 4CIF / 2CIF / CIF / QCIF Channel 2-4: CIF / QCIF	Channel 1: 4CIF / 2CIF / CIF / QCIF Channel 2-8: CIF / QCIF
Frame rate	25 fps (P) / 30 fps (N)	
Video bit rate	32 Kbps - 2048 Kbps, or user defined (max. 3072 Kbps)	
Audio output	1-ch, BNC (linear electrical level, 600 Ω)	
Audio bit rate	64 Kbps	
Dual stream	Support	
Stream type	Video, Video & Audio	
Synchronous playback	4-ch	
<b>Hard disk</b>		
SATA	4 SATA interfaces	
eSATA	1 eSATA interface (optional)	
Capacity	Up to 2 TB capacity for each disk	
<b>External interface</b>		
Network interface	1, RJ45 10M / 100M self-adaptive ethernet interface	
Serial interface	1 RS-232 interface, 1 RS-485 interface	
USB interface	2, USB 2.0	
Alarm in	9	
Alarm out	4	
<b>General</b>		
Power supply	100 - 240 VAC, 6.3A, 50 - 60Hz	
Consumption	≤ 40W (without hard disk or DVD-R/W)	≤ 45W (without hard disk or DVD-R/W)
Working temperature	-10 °C ~ +55 °C	
Working humidity	10% - 90%	
Dimensions (W × D × H)	180 × 280 × 180 mm	
Weight	≤ 5kg (without hard disk or DVD-R/W)	

# DS-8104/8108AHF(L)I-ST ATM DVR



## Key Features

- H.264 video compression
- 4CIF resolution real time recording
- Dual-stream
- 4 SATA interfaces
- HDD group management



Rear Panel of DS-8108AHF(L)I-ST



- |                                  |                                    |
|----------------------------------|------------------------------------|
| 1. Video in                      | 7. eSATA interface                 |
| 2. Audio in                      | 8. RS-485 interface                |
| 3. Video out, audio out, line in | 9. Alarm in, alarm out             |
| 4. RS-232 interface              | 10. 12 VDC power output for camera |
| 5. VGA                           | 11. Power switch                   |
| 6. LAN interface                 | 12. GND                            |

## Specifications

	DS-8104AHF(L)I-ST	DS-8108AHF(L)I-ST
<b>Video/Audio input</b>		
Analog video input	4-ch BNC connector (1.0 Vp-p, 75 Ω); PAL/NTSC self-adaptive	8-ch
Audio input	4-ch BNC connector (2.0 Vp-p, 1 kΩ)	8-ch
Voice talk input	1-ch, BNC connector (2.0 Vp-p, 1 kΩ)	
<b>Video/Audio output</b>		
CVBS output	1-ch, BNC connector (1.0 Vp-p, 75 Ω); Resolution: PAL: 704×576, NTSC: 704×480	
VGA output	1-ch, resolution: 1280×1024 / 60 Hz , 1024×768 / 60 Hz	
LCD Display	Available on DS-8104AHFLI-ST and DS-8108AHFLI-ST models	
Audio output	1-ch, BNC connector (linear, 600 Ω)	
<b>Video/Audio encoding</b>		
Video compression	H.264	
Recording resolution	4CIF/ DCIF / 2CIF / CIF / QCIF	
Frame rate	25 fps(P) /30 fps(N)	
Video bit rate	32 Kbps~2048 Kbps, or user defined (max. 3072 Kbps)	
Stream type	Video, Video & Audio	
Dual stream	Support	
Audio compression	OggVorbis	
Audio bit rate	16kbps	
Synchronous playback	2-ch	4-ch
<b>Hard disk</b>		
SATA	4 SATA interfaces	
eSATA	1 eSATA interface (optional)	
Capacity	Up to 2TB capacity for each disk	
<b>External interface</b>		
Network interface	1, RJ45 10M/100M/1000M self-adaptive ethernet interface	
Serial interface	1 RS-485 interface, 1 RS-232 interface	
USB interface	2, USB2.0	
Alarm in	9	
Alarm out	4	
<b>General</b>		
Power supply	100 ~ 240 VAC, 6.3A, 50-60 Hz	
Consumption	≤ 40W (without hard disk or DVD-R/W)	≤ 45W (without hard disk or DVD-R/W)
Working temperature	-10 °C ~+55 °C	
Working humidity	10%~90%	
Chassis	Chassis for ATM DVR	
Dimensions (W × D × H)	180 × 280 × 180 mm	
Weight	≤ 5kg (without hard disk or DVD-R/W)	

# DS-8104HMI-A Mobile DVR



## Key Features

- H.264 video compression
- Up to 4CIF resolution recording
- 2x2.5-inch SATA interfaces
- Patented hard disk vibration-proof and bracing technology
- Built-in 3G (WCDMA/cdma2000) module (optional)
- Built-in GPS module

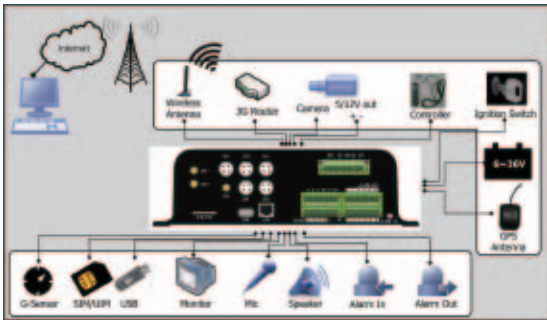

## Specifications

DS-8104HMI-A	
<b>Video/Audio input</b>	
Video compression	H.264
Video input	4-ch, aviation interface (PAL / NTSC self-adaptive; 1.0 Vp-p, 75 Ω)
Audio compression	OggVorbis, 16Kbps
Audio input	4-ch, aviation interface (linear level, 1 kΩ)
<b>Video/Audio output</b>	
Preview resolution	PAL:704×576, NTSC:704×480
Encoding resolution	4CIF/ DCIF / 2CIF / CIF / QCIF
Video output	1-ch, aviation interface (PAL / NTSC self-adaptive; 1.0 Vp-p, 75 Ω)
Frame rate	4CIF:6fps DCIF:12fps 2CIF:15fps CIF/QCIF:25fps (P) /30fps (N)
Video bit rate	32 Kbps-2048 Kbps, or user defined (max. 8 Mbps)
Audio output	1-ch, aviation interface (linear level, 600 Ω)
Stream type	Video, Video & Audio
<b>Hard disk</b>	
SATA	2 SATA interfaces
Size	2.5-inch
<b>External interface</b>	
Network interface	1, RJ45 10M / 100M self-adaptive ethernet interface
3G antenna interface	2 antennas, SMA interface
Serial interface	1, RS-485 interface
USB interface	1, USB 2.0
Alarm in	7-ch input, the 8th channel is reserved
Alarm out	2-ch
Remote control	IR remote controller
GPS	Built-in GPS module, 1 antenna, SMA interface
<b>General</b>	
Power input	6-36 VDC
Power output	12V/2A DC, 5V/2A DC output, built-in resettable fuse
Power-off delay	Shut down delay after ignition off (from 5minutes to 6hours)
Schedule On/Off:	Daily scheduled power on/off (00:00-24:00)
Consumption	≤ 10W (without SD cards)
Working temperature	-15 °C ~ +55 °C
Working humidity	10%~95%
Dimensions (W × D × H)	210 × 236 × 73 mm
Weight	≤ 3kg (without SD cards)

Rear Panel of DS-8104HMI-A



1. DC in power input & key startup control interface
2. Aviation plug for video/audio input, power output
3. Video / audio output
4. Main / Aux antenna interface for wireless network
5. SIM / UIM card interface
6. GPS antenna interface
7. USB interface
8. LAN network interface
9. DC out power output (+5V/+12V)
10. RS485 interface
11. Wired-remote control
12. Alarm input
13. Alarm output

# DS-8104HMI-B Mobile DVR



## Key Features

- H.264 video compression
- Up to 4CIF resolution recording
- 2 x 2.5-inch SATA interfaces
- Patented hard disk vibration-proof and bracing technology
- Built-in 3G (WCDMA/cdma2000) module (optional)

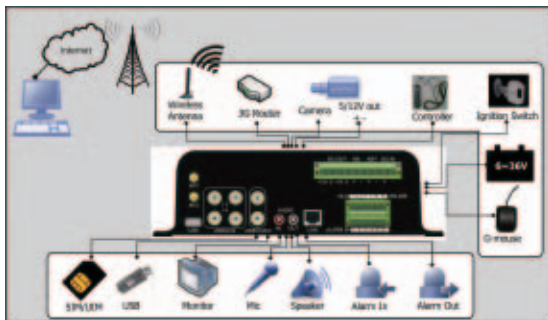

Rear Panel of DS-8104HMI-B

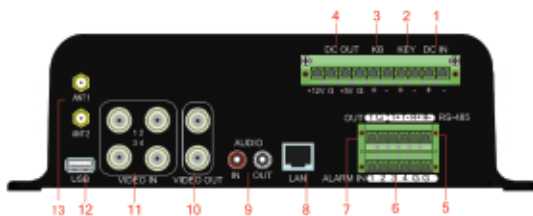

- |                                  |   |
|----------------------------------|---|
| 1. DC in power input             | 8. LAN network interface                              |
| 2. Key startup control interface | 9. Audio input/output                                 |
| 3. Wired-remote control          | 10. Video output, 1-Main, 2-Aux                       |
| 4. DC out power output           | 11. Video input, 4-ch                                 |
| 5. RS485 interface               | 12. USB interface                                     |
| 6. Alarm input                   | 13. Main / Aux antenna interface for wireless network |
| 7. Alarm output                  |   |

## Specifications

DS-8104HMI-B	
<b>Video/Audio input</b>	
Video compression	H.264
Video input	4-ch, BNC (1.0 Vp-p, 75Ω), PAL / NTSC self-adaptive
Audio compression	OggVorbis, 16Kbps
Audio input	1-ch, RCA (2.0~2.4 Vp-p, 1 kΩ)
<b>Video/Audio output</b>	
Preview resolution	PAL:704×576, NTSC:704×480
Encoding resolution	4CIF/ DCIF / 2CIF / CIF / QCIF
Video output	2-ch, BNC(1.0 Vp-p, 75 Ω), PAL/NTSC self-adaptive
Frame rate	4CIF:6fps DCIF:12fps 2CIF:15fps CIF/QCIF:25fps (P) /30fps (N)
Video bit rate	32 Kbps~2048 Kbps, or user defined (max. 8 Mbps)
Audio output	1-ch, RCA(2.0~2.4 Vp-p, 600 Ω)
Stream type	Video, Video & Audio
<b>Hard disk</b>	
SATA	2 SATA interfaces
Size	2.5-inch
<b>External interface</b>	
Network interface	1, RJ45 10M / 100M self-adaptive ethernet interface
3G antenna interface	2 antennas, SMA interface
Serial interface	1, RS-485 interface
USB interface	1, USB 2.0
Alarm in	4-ch
Alarm out	1-ch
Remote control	IR remote controller
GPS	connect external GPS module via RS-485 port
<b>General</b>	
Power input	6-36 VDC
Power output	12V/2A DC, 5V/2A DC output, built-in resettable fuse
Power-off delay	Shut down delay after ignition off (from 5min to 6 hours)
Schedule On/Off:	Daily scheduled power on/off (00:00~24:00)
Consumption	≤ 10W (without SD cards)
Working temperature	-15 °C ~ +55 °C
Working humidity	10% ~ 95%
Dimensions (W × D × H)	210 × 236 × 73 mm
Weight	≤ 3kg (without SD cards)

# DS-8104HMI-M Mobile DVR



## Key Features

- H.264 video compression
- Up to 4CIF resolution recording
- SD card slot for on-board storage
- Patented hard disk vibration-proof and bracing technology
- Built-in 3G (WCDMA/cdma2000) module (optional)

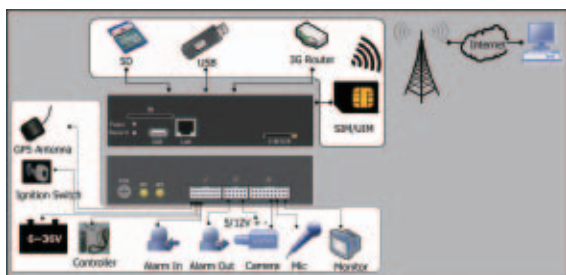

Panel of DS-8104HMI-M



1. Safety fuse
2. Antenna interface for wireless network
3. GPS antenna interface
4. Power Input, driving signal input, wired-remote control & KEY startup control interface
5. RS485, power output and alarm out interface
6. Video input/output & camera power interface



1. SD card interface
2. SIM/UM card interface
3. UTP network interface
4. USB interface
5. Indicators

DS-8104HMI-M	
<b>Video/Audio input</b>	
Video compression	H.264
Video input	4-ch, Aviation Connector(1.0 Vp-p, 75 Ω)
Audio compression	OggVorbis, 16 Kbps
Audio input	2-ch, Aviation Interface (linear electrical level, 1 kΩ)
<b>Video/Audio output</b>	
Preview resolution	PAL: 704 × 576, NTSC: 704 × 480
Encoding resolution	4CIF/DCIF/2CIF/CIF/QCIF
Video output	1-ch, (PAL/NTSC self-adaptive; 1.0 Vp-p, 75 Ω)
Frame rate	4CIF:6 fps DCIF:12 fps 2CIF:15 fps CIF/QCIF:25 fps(P) /30 fps(N)
Video bit rate	32 Kbps~2048 Kbps, or user defined (Max. 8 Mbps)
Audio output	1-ch, BNC(2.0~2.4 Vp-p, 600 Ω)
Stream Type	Video, Video & Audio
<b>External interface</b>	
Network interface	1, RJ45 10M/100M self-adaptive ethernet interface
3G antenna interface	2 antennas, SMA interface
USB interface	1, USB 2.0
SD Card Interface	Support 1 SD/SDHC card for recording
Serial interface	1, RS-485 interface
Alarm in	7-ch input, the 8th channel is reserved
Alarm out	2-ch
GPS	Built-in module, 1 antenna, SMA interface (optional)
<b>General</b>	
Power input	6~36 VDC
Power output	12 VDC /5 VDC, built-in resettable fuse
Power-off Delay	Shut down delay after ignition off (from 5min to 6h)
Schedule On/Off:	Daily scheduled power on/off (00:00~24:00)
Consumption	≤ 5 W (without SD cards)
Working temperature	-15 °C ~ +55 °C
Working humidity	10%~95%
Dimensions (W × D × H)	105 × 155 × 45 mm
Weight	≤ 1 kg (without SD card)



# DS-8104/8108/8112/8116HMF1-T Mobile DVR



## Key Features

- H.264 video compression
- 2x2.5" pluggable SATA HDD/SSD
- Power-off protection and redundant power supply
- Built-in 3G (WCDMA/cdma2000) module
- Built-in high-sensitivity GPS module
- Various interfaces

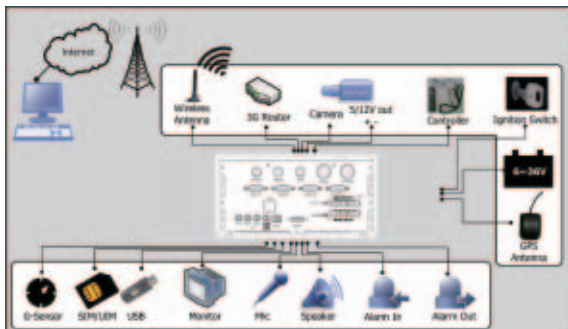

## Specifications

	DS-8104HMF1-T	DS-8108HMF1-T	DS-8112HMF1-T	DS-8116HMF1-T
<b>Video/Audio input</b>				
Analog Video Input	4-ch	8-ch	12-ch	16-ch
	Aviation plug (1.0 Vp-p, 75 Ω), PAL/NTSC self-adaptive			
Audio Input	4-ch	8-ch	12-ch	16-ch
	Aviation plug (linear electrical level, 1 kΩ)			
<b>Video/Audio output</b>				
Video Output	2-ch CVBS video output, aviation plug (1.0 Vp-p, 75 Ω) Resolution: PAL: 704×576, NTSC: 704×480			
Audio Output	2-ch, aviation plug (linear electrical level, 600 Ω)			
<b>Video/Audio Compression</b>				
Video Compression	H.264			
Encoding resolution	4CIF/ DCIF / 2CIF / CIF / QCIF			
Video Frame Rate	25 fps(P) /30 fps(N)			
Video Bit Rate	32 Kbps-2048 Kbps, or user defined (Max. 8 Mbps)			
Stream Type	Video, Video & Audio			
Audio Compression	G.711			
Audio Bit Rate	16 Kbps			
<b>HDD Disk</b>				
HDD Type	2 2.5-inch SATA interfaces for Pluggable HDD /SSD disks			
HDD Patent	Patented hard disk vibration reduction technology			
Data Backup	Backup by pluggable HDD /eSATA /USB devices			
<b>Wireless Transmission</b>				
3G	Built-in cdma2000, WCDMA module (optional)			
<b>GPS</b>				
GPS	Built-in high-sensitivity GPS chip			
<b>External Interfaces</b>				
Driving Information Collection	4-ch high/low-level signal input, 1-ch pulse signal input (reserved)			
Alarm In	3-ch high/low-level signal input			
Alarm Out	2-ch relay output			
LAN	1 RJ-45 network interface			
Antenna interface	SMA interfaces for 2 3G antennas, 1 WIFI antenna and 1 GPS antenna			
USB/eSATA Interface	1 USB/eSATA Interface			
Serial Interface	1 RS-232 interface;1 RS-422 interface			
SIM	1 standard SIM slot			
SD/SDHC	1 standard SD/SDHC slot			
<b>General</b>				
Operating System	Embedded Linux Operating System			
Power Supply	Input: +6 ~ +36 VDC; Output: +12 VDC /2 A, +5 VDC /2 A			
Operating Mode	IR Remote Control			
Power Consumption	≤ 25 W			
Working Temperature	-15 °C ~ +55 °C			
Working Humidity	10% ~ 95%			
Dimensions (W×D×H)	205 × 251 × 102.3 mm			
Weight	≤ 4.5 kg			

# DS-1004HMI Mobile DVR Backup Device



## Key Features

- Suitable for DS-8100HMI, DS-8008HMI/HMFI, DS-8012HMI/HMFI, DS-8104/8108/8112/8116HMFI-T
- Simple and convenient
- 2 SATA and 1 eSATA interface

Rear Panel of DS-1004HMI



1. USB interface
2. USB status Indicator
3. Power status Indicator
4. eSATA interface
5. DC IN interface

## Specifications

	DS-1004HMI
<b>Hard disk</b>	
SATA	2 SATA interface
Capacity	support 2.5" SATA HDD /SSD
<b>External interface</b>	
e-SATA interface	1 eSATA interface
USB interface	1 USB2.0 interface
<b>General</b>	
Power supply	+12 VDC
Power consumption	2 W (without HDD)
Working temperature	-15 °C~+55 °C
Working humidity	10%~90%
Dimensions (W × D × H)	203 x 146 x 79 mm
Weight	≤ 1.5 kg (without HDD)

# DIGITAL VIDEO SERVER



# DS-6601/6602/6604HFI Digital Video Server



## Key Features

- H.264 video compression
- 4CIF resolution recording
- Dual-stream
- SADP (IP finder), UDP, RTP and RTSP network protocols

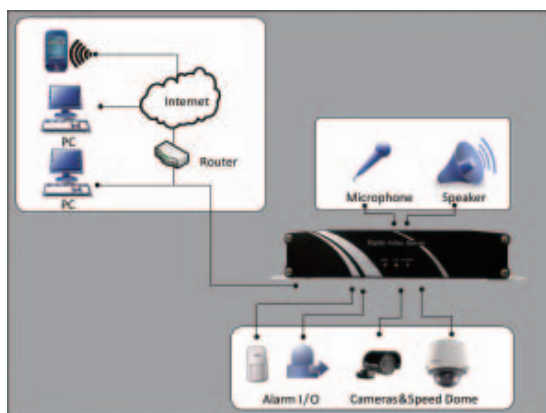

## Specifications

	DS-6601HFI	DS-6602HFI	DS-6604HFI
<b>Video/Audio input</b>			
Video Compression	H.264		
Video input	1-ch, BNC (1.0 Vp-p, 75 Ω)	2-ch, BNC (1.0 Vp-p, 75 Ω)	4-ch, BNC (1.0 Vp-p, 75 Ω)
Audio Compression	OggVorbis		
Audio input	1-ch, BNC (2.0 Vp-p, 1 kΩ)	2-ch, BNC (2.0 Vp-p, 1 kΩ)	4-ch, BNC (2.0 Vp-p, 1 kΩ)
Voice talk input	1-ch, 3.5 mm audio interface (2.0 Vp-p, 1 kΩ)		
<b>Video/ Audio output</b>			
Audio output	1-ch, 3.5 mm audio interface (2.0 Vp-p, 600 Ω)		
Encoding resolution	4CIF / 2CIF / CIF / QCIF		
Frame rate	4CIF: 25 fps (P) /30 fps (N)		
Video bit rate	32 Kbps ~ 2048 Kbps, or user defined (Max. 3 Mbps)		
Audio bit rate	64 Kbps		
Dual-stream	Support		
Stream type	Video, Video & Audio		
<b>External interface</b>			
Network interface	1RJ-45 10 M /100 Mbps self-adaptive UTP ethernet interface		
Serial interface	1 RS-485 interface (PTZ control), 1 RS-232 interface		
Alarm in	4		
Alarm out	2		
<b>General</b>			
Power supply	12 VDC		
Consumption	≤ 8 W (without HDD or DVD-R/W)		
Working temperature	-10 °C ~ +55 °C		
Working humidity	10% ~ 90%		
Dimensions (W × D × H)	200.5 × 136 × 42 mm		
Weight	≤ 2 kg		

Rear Panel of DS-6604HFI



1. GND
2. DC12V
3. RS-485 serial interface
4. Alarm out
5. Alarm in
6. Reset
7. LAN (10M/100Mbps self-adaptive UTP Ethernet interface)
8. RS-232 Serial Interface
9. Video in
10. Audio in
11. Line in
12. Audio out

# DS-6601/6602/6604HFI-SATA Digital Video Server

## Specifications

	DS-6601HFI-SATA	DS-6602HFI-SATA	DS-6604HFI-SATA
<b>Video/Audio input</b>			
Video Compression	H.264		
Video input	1-ch, BNC (1.0 Vp-p, 75 Ω)	2-ch, BNC (1.0 Vp-p, 75 Ω)	4-ch, BNC (1.0 Vp-p, 75 Ω)
Audio Compression	OggVorbis		
Audio input	1-ch, BNC (2.0 Vp-p, 1 kΩ)	2-ch, BNC (2.0 Vp-p, 1 kΩ)	4-ch, BNC (2.0 Vp-p, 1 kΩ)
Voice talk input	1-ch, 3.5 mm audio interface (2.0 Vp-p, 1 kΩ)		
<b>Video/ Audio output</b>			
Audio output	1-ch, 3.5 mm audio interface (2.0 Vp-p, 600 Ω)		
Encoding resolution	4CIF / 2CIF / CIF / QCIF		
Frame rate	4CIF: 25 fps (P) / 30 fps (N)		
Video bit rate	32 Kbps ~ 2048 Kbps, or user defined (Max. 3 Mbps)		
Audio bit rate	64 Kbps		
Dual-stream	Support		
Stream type	Video, Video & Audio		
<b>Hard disk</b>			
SATA	1 SATA interface		
Capacity	Up to 2 TB capacity		
<b>External interface</b>			
Network interface	1RJ-45 10 M /100 Mbps self-adaptive UTP ethernet interface		
Serial interface	1 RS-485 interface (PTZ control), 1 RS-232 interface		
Alarm in	4		
Alarm out	2		
<b>General</b>			
Power supply	12 VDC		
Consumption	≤ 8 W (without HDD or DVD-R/W)		
Working temperature	-10 °C ~ +55 °C		
Working humidity	10% ~ 90%		
Dimensions (W ×D × H)	315 × 201 × 45 mm		
Weight	≤ 2 kg (without HDD)		



## Key Features

- H.264 video compression
- 4CIF resolution recording
- Dual-stream
- SADP(IP finder), UDP, RTP and RTSP network protocols

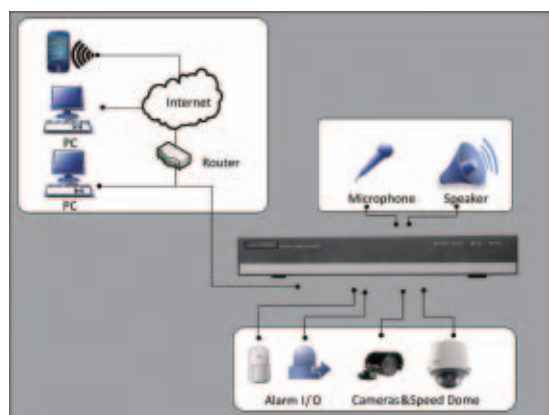

Rear Panel of DS-6604HFI-SATA



- |   |               |
|---|---------------|
| 1. DC12V  | 9. Audio in   |
| 2. RS-485 serial interface                                | 10. Line in   |
| 3. Alarm out  | 11. Audio out |
| 4. Alarm in   | 12. G         |
| 5. Reset  |               |
| 6. LAN (10M/100Mbps self-adaptive UTP Ethernet interface) |               |
| 7. RS-232 serial interface                                |               |
| 8. Video in   |               |

# DS-6508/6516HCI Digital Video Server



## Key Features

- High performance DSP hardware compression
- H.264 video compression
- Dual-stream
- Variable bit rate and frame rate
- Multi-zone motion detection and private masking
- Multi-level user access management

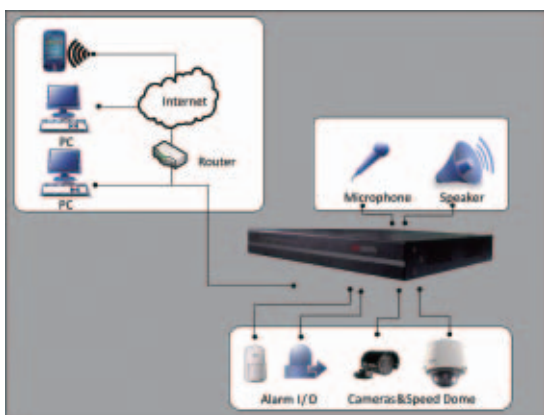

Rear Panel of DS-6508HCI



1. Video in, audio in
2. Loop out (optional)
3. Line in
4. Audio out
5. RS-232 serial interface
6. Power On/Off
7. LAN (10/100/1000Mbps self-adaptive UTP Ethernet interface)
8. Reset
9. RS-485 serial interface
10. Alarm out
11. Alarm in
12. AC220V power input
13. GND

## Specifications

	DS-6508HCI	DS-6516HCI
<b>Video/Audio input</b>		
Video Compression	H.264	
Video input	8-ch, BNC (1.0 Vp-p, 75 Ω)	16-ch, BNC (1.0 Vp-p, 75 Ω)
Audio compression	OggVorbis	
Audio input	8-ch, BNC (2.0 Vp-p, 1 kΩ)	16-ch, BNC (2.0 Vp-p, 1 kΩ)
Voice talk input	1-ch, 3.5 mm audio interface (2.0 Vp-p, 1 kΩ)	
<b>Video/Audio output</b>		
Video loop out	DB26 connector (Optional)	
Audio output	1-ch, 3.5 mm audio interface (2.0 Vp-p, 600 Ω)	
Encoding resolution	4CIF / 2CIF / CIF / QCIF	
Frame rate	4CIF: 8 fps 2CIF: 16 fps, CIF: 25 (P) /30 (N) fps	4CIF: 2 fps 2CIF: 12 fps, CIF: 25 (P) /30(N) fps
Video bit rate	32 Kbps ~ 1024 Kbps, or user defined (Max. 1 Mbps)	
Dual-stream	Support	
Stream type	Video, Video & Audio	
<b>External interface</b>		
Network interface	1RJ45 10 /100 /1000Mbps self-adaptive UTP Ethernet interface	
Serial interface	1 RS485, 1 RS232 (DB9 Port)	
Alarm in	16	
Alarm out	4	
<b>General</b>		
Power supply	100 ~ 240 VAC, 6.3 A, 50-60 Hz	
Consumption	≤ 40 W (without HDD)	
Working temperature	-10 °C ~ +55 °C (14 °F ~ 131 °F)	
Working humidity	10% ~ 90%	
Dimensions (W × D × H)	440 × 300 × 45 mm	
Chassis	1U, 19-inch	
Weight (without HDD)	≤ 5 kg	

# DS-6508/6516HCI-SATA Digital Video Server



## Key Features

- High performance DSP hardware compression
- H.264 video compression
- Dual-stream
- Variable bit rate and frame rate
- Multi-zone motion detection and private masking
- Multi-level user access management
- 1 SATA interface for local storage

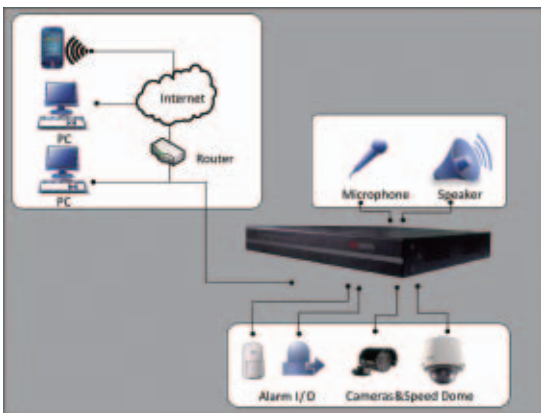

Rear Panel of DS-6508HCI-SATA



1. Video in, audio in
2. Loop out (optional)
3. Line in
4. Audio out
5. RS-232 serial interface
6. Power On/Off
7. LAN (10/100/1000Mbps self-adaptive UTP Ethernet interface)
8. Reset
9. RS-485 Serial Interface
10. Alarm out
11. Alarm in
12. AC220V power input
13. GND

## Specifications

	DS-6508HCI-SATA	DS-6516HCI-SATA
<b>Video/Audio input</b>		
Video Compression	H.264	
Video input	8-ch, BNC (1.0 Vp-p, 75 Ω)	16-ch, BNC (1.0 Vp-p, 75 Ω)
Audio compression		
Audio input	8-ch, BNC (2.0 Vp-p, 1 kΩ)	16-ch, BNC (2.0 Vp-p, 1 kΩ)
Voice talk input	1-ch, 3.5 mm audio interface (2.0 Vp-p, 1 kΩ)	
<b>Video/Audio output</b>		
Video loop out	DB26 connector (Optional)	
Audio output	1-ch, 3.5 mm audio interface (2.0 Vp-p, 600 Ω)	
Encoding resolution	4CIF / 2CIF / CIF / QCIF	
Frame rate	4CIF: 8 fps 2CIF: 16 fps, CIF: 25 (P) /30 (N) fps	4CIF: 2 fps 2CIF: 12 fps, CIF: 25 (P) /30 (N) fps
Video bit rate	32 Kps ~ 1024 Kbps, or user defined (Max. 1 Mbps)	
Dual-stream	Support	
Stream type	Video, Video & Audio	
<b>Hard disk</b>		
SATA	1 SATA interface	
Capacity	Up to 2TB	
<b>External interface</b>		
Network interface	1 RJ45 10 /100 /1000Mbps self-adaptive UTP Ethernet interface	
Serial interface	1 RS485, 1 RS232 (DB9 Port)	
Alarm in	16	
Alarm out	4	
<b>General</b>		
Power supply	100~240 VAC, 6.3 A, 50 ~ 60 Hz	
Consumption	≤ 40 W (without HDD)	
Working temperature	-10 °C ~ +55 °C (14 °F ~ 131 °F)	
Working humidity	10% ~ 90%	
Dimensions (W × D × H)	440 × 300 × 45 mm	
Chassis	1U, 19-inch	
Weight (without HDD)	≤ 5 kg	

# DS-6508/6516HFI Digital Video Server



## Key Features

- High performance DSP hardware compression
- H.264 video compression
- Dual-stream
- Variable bit rate and frame rate
- Multi-zone motion detection and private masking
- Multi-level user access management

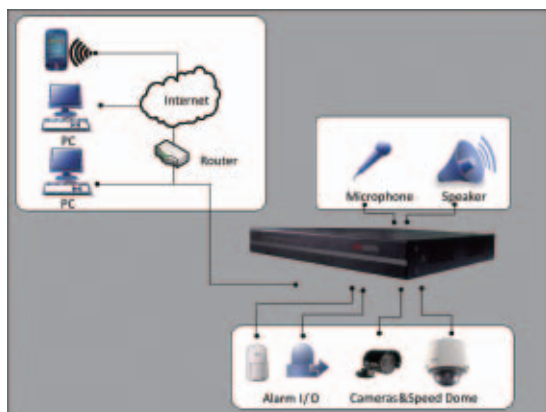

Rear Panel of DS-6508HFI



1. Video in, audio in
2. Loop out (optional)
3. Line in
4. Audio out
5. RS-232 serial interface
6. Power On/Off
7. LAN (10/100/1000Mbps self-adaptive UTP Ethernet interface)
8. Reset
9. RS-485 serial interface
10. Alarm out
11. Alarm in
12. AC220V power input
13. GND

## Specifications

	DS-6508HFI	DS-6516HFI
<b>Video/Audio input</b>		
Video Compression	H.264	
Video input	8-ch, BNC (1.0 Vp-p, 75 Ω)	16-ch, BNC(1.0 Vp-p, 75 Ω)
Audio compression	OggVorbis	
Audio input	8-ch, BNC (2.0 Vp-p, 1 kΩ)	16-ch, BNC(2.0 Vp-p, 1 kΩ)
Voice talk input	1-ch, 3.5 mm audio interface (2.0 Vp-p, 1 kΩ)	
<b>Video/Audio output</b>		
Video loop out	DB26 connector (Optional)	
Audio output	1-ch, 3.5 mm audio interface (2.0 Vp-p, 600 Ω)	
Encoding resolution	4CIF / 2CIF / CIF / QCIF	
Frame rate	4CIF: 25 fps (P) / 30 fps(N)	
Video bit rate	32 Kbps ~ 2048 Kbps, or user defined (Max. 3 Mbps)	
Dual-stream	Support	
Stream type	Video, Video & Audio	
<b>External interface</b>		
Network interface	1RJ45 10/100/1000Mbps self-adaptive UTP Ethernet interface	
Serial interface	1 RS485, 1 RS232 (DB9 Port)	
Alarm in	16	
Alarm out	4	
<b>General</b>		
Power supply	100 ~ 240 VAC, 6.3 A, 50-60 Hz	
Consumption	≤ 40 W (without HDD)	
Working temperature	-10 °C ~ +55 °C (14 °F ~ 131 °F)	
Working humidity	10% ~ 90%	
Dimensions (W × D × H)	440 × 300 × 45 mm	
Chassis	1U, 19-inch	
Weight (without HDD)	≤ 5 kg	



# DS-6508/6516HFI-SATA Digital Video Server



## Key Features

- High performance DSP hardware compression
- H.264 video compression
- Dual-stream
- Variable bit rate and frame rate
- Multi-zone motion detection and private masking
- Multi-level user access management
- 1 SATA interface for local storage

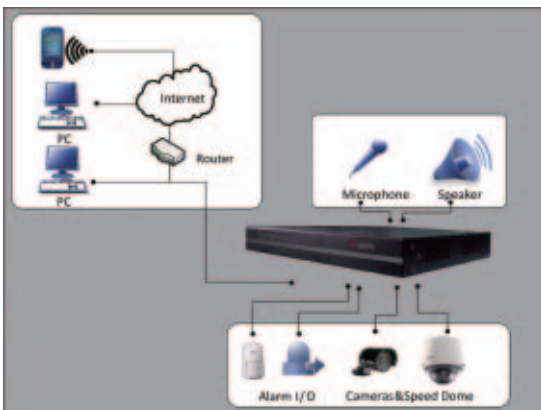

## Specifications

	DS-6508HFI-SATA	DS-6516HFI-SATA
<b>Video/Audio input</b>		
Video Compression	H.264	
Video input	8-ch, BNC (1.0 Vp-p, 75 Ω)	16-ch, BNC (1.0 Vp-p, 75 Ω)
Audio compression	OggVorbis	
Audio input	8-ch, BNC (2.0 Vp-p, 1 kΩ)	16-ch, BNC (2.0 Vp-p, 1 kΩ)
Voice talk input	1-ch, 3.5 mm audio interface (2.0 Vp-p, 1 kΩ)	
<b>Video/Audio output</b>		
Video loop out	DB26 connector (Optional)	
Audio output	1-ch, 3.5 mm audio interface (2.0 Vp-p, 600 Ω)	
Encoding resolution	4CIF / 2CIF / CIF / QCIF	
Frame rate	4CIF: 25 fps (P) / 30 fps (N)	
Video bit rate	32 Kbps ~ 2048 Kbps, or user defined (Max. 3 Mbps)	
Dual-stream	Support	
Stream type	Video, Video & Audio	
<b>Hard disk</b>		
SATA	1 SATA interface	
Capacity	Up to 2TB	
<b>External interface</b>		
Network interface	1 RJ45 10 /100 /1000Mbps self-adaptive UTP Ethernet interface	
Serial interface	1 RS485, 1 RS232(DB9 Port)	
Alarm in	16	
Alarm out	4	
<b>General</b>		
Power supply	100 ~ 240 VAC, 6.3 A, 50 ~ 60 Hz	
Consumption	≤ 40 W (without HDD)	
Working temperature	-10 °C ~ +55 °C (14 °F ~ 131 °F)	
Working humidity	10% ~ 90%	
Dimensions (W × D × H)	440 × 300 × 45 mm	
Chassis	1U, 19-inch	
Weight (without HDD)	≤ 5 kg	

Rear Panel of DS-6508HFI-SATA



1. Video in, audio in
2. Loop out (optional)
3. Line in
4. Audio out
5. RS-232 serial interface
6. Power On/Off
7. LAN (10/100/1000Mbps self-adaptive UTP Ethernet interface)
8. Reset
9. RS-485 serial interface
10. Alarm out
11. Alarm in
12. AC220V power input
13. GND

# DS-6101HFI-IP-A Digital Video Server



DS-6101HFI-IP-A

## Key Features

- High performance DSP hardware compression
- H.264 video compression
- Dual-stream
- Support variable bit rate and frame rate
- Embedded Linux OS

## Specifications

DS-6101HFI-IP-A	
<b>Video/Audio input</b>	
Video compression	H.264
Video input	1-ch
Video input interface	BNC (1.0 Vp-p, 75 Ω)
Audio compression	OggVorbis, 16 Kbps
Audio input	1-ch
Audio input interface	BNC (2.0 Vp-p, 1 kΩ)
Voice talk input	1-ch, 3.5 mm audio interface (2.0 Vp-p, 1 kΩ)
<b>Video/Audio output</b>	
Encoding /Decoding resolution	4CIF / DCIF / 2CIF / CIF /QCIF
Frame rate	25 fps (P) /30 fps (N)
Dual-stream	Support
Video bit rate	32 Kbps ~ 2 Mbps, or user defined (Max. 8 Mbps)
Audio output	1-ch, 3.5 mm audio interface (2.0 Vp-p, 600 Ω)
Stream type	Video, Video & Audio
<b>External interface</b>	
Network interface	1 RJ45 10M /100M self-adaptive Ethernet interface
RS-232 Port	1 RJ45 RS-232 Port
RJ-485 port	1 (T+, T-)
Alarm in	1
Alarm out	1
<b>General</b>	
Power supply	12 VDC
Consumption	≤ 12 W
Working temperature	-10 °C ~ +55 °C (14 °F ~ 131 °F)
Working humidity	10% ~ 90%
Dimensions (W × D × H)	120 x 70 x 45 mm
Weight (without HDD)	≤ 0.5 kg

# IP Module

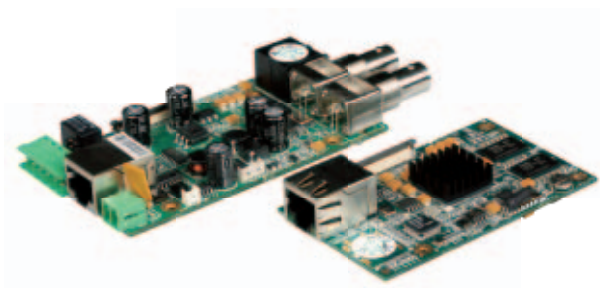

Hikvision IP module applies Embedded Linux OS and the latest TI DaVinci platform. The product can be embedded into analog camera and analog speed dome to build up network camera and network speed dome. With chassis, IP module can also be used as one channel network digital video server.

## Specifications

IP Module	
<b>Video/Audio input</b>	
Video compression	H.264
Video input	1-ch
Video input interface	BNC (1.0Vp-p, 75 Ω)
Audio compression	OggVorbis, 16 Kbps
Audio input	1-ch
Audio input interface	BNC (2.0 Vp-p, 1 kΩ)
Voice talk input	1-ch, 3.5 mm audio interface (2.0 Vp-p, 1 kΩ)
<b>Video/Audio output</b>	
Encoding resolution	4CIF / DCIF / 2CIF / CIF / QCIF
Frame rate	25 fps (P) /30 fps (N)
Stream type	Video, Video & Audio
Dual-stream	Support
Video bit rate	32 Kbps ~ 2 Mbps, or user defined (Max. 8 Mbps)
Audio output	1-ch, 3.5 mm audio interface (2.0 Vp-p, 600 Ω)
<b>External interface</b>	
Network interface	1 RJ45 10M /100M self-adaptive Ethernet interface
RS-232 Port	1 RJ45 RS-232 Port
RS-485 port	1 (T+, T-)
Alarm in	1
Alarm out	1
<b>General</b>	
Power supply	12 VDC
Consumption	≤ 12 W
Working temperature	-10 °C ~ +55 °C (14 °F ~ 131 °F)
Working humidity	10% ~ 90%
Dimensions	Compression board: 48 x 80 mm Chassis board: 53 x 94 mm
Weight(without HDD)	≤ 0.5 kg

# DS-6101DI Digital Video Server



## Key Features

- H.264 /MPEG4 video compression
- Third-party network cameras supported
- Up to 4CIF resolution decoding
- TCP, UDP, MCAST and RTP transmission protocols

## Specifications

	DS-6101DI
IP video input	H.264 / MPEG4
Decoding resolution	4CIF / DCIF / 2CIF / CIF / QCIF
Video output	1-ch CVBS output, resolution: 704×576 (PAL); 704× 480 (NTSC)
Frame rate	25 fps (P) /30 fps (N)
Stream type	Video, Video & Audio
Video bit rate	2M-12M adjustable (bps)
Audio output	1-ch, RCA (2.0~2.4 Vp-p, 600 Ω)
Voice talk input	1-ch, 3.5 mm audio interface (2.0~2.4 Vp-p, 1 kΩ)
Communication Interface	1 RJ45 10M /100M /1000M self-adaptive Ethernet interface 1 RJ45 RS-232 port, 1 RJ45 RS-485 port
Alarm in	4
Alarm out	2
Power Supply	12 VDC
Consumption	12 W
Working Temperature	-10 °C ~ +55 °C (14 °F ~ 131 °F)
Working Humidity	10%~90%
Dimensions (W × D × H)	198 × 123 × 39 mm
Weight	1.5 kg

Rear Panel of DS-6101DI



1. PWR, power LED indicator
2. LINK, network connection status LED indicator
3. RX/TX, data transmitting/receiving status LED indicator
4. RESET, reset to the default parameters
5. VIDEO OUT, BNC video output



1. MIC IN, voice talk input
2. Audio out
3. RS-232 serial interface
4. RS-485 serial interface
5. Alarm in/ alarm out(4 inputs/2 outputs)
6. LAN, 10/100/1000Mbps self-adaptive UTP Ethernet interface
7. 12VDC power input
8. GND, grounding

# DS-6401HDI High Definition Decoder Server



## Key Features

- High performance DSP hardware decompression
- Decoding capability: Up to 1-ch video stream at HD1080P (1920x1080) resolution, 2-ch video streams at HD720P (1280x720) resolution or 4-ch video streams at 4CIF resolution
- HDMI, DVI, VGA and BNC video output

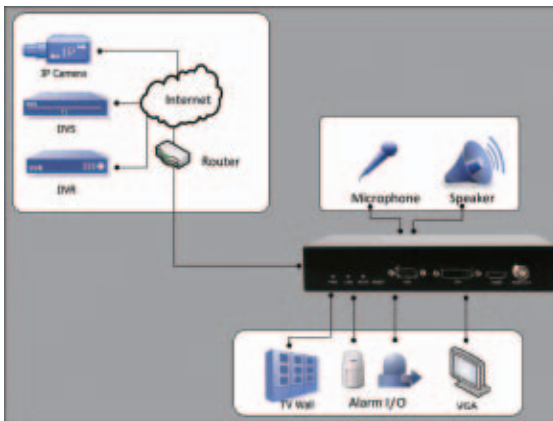

## Specifications

	DS-6401HDI
<b>Audio/Video Output</b>	
CVBS output	1-ch BNC output, resolution: PAL: 704 × 576, NTSC: 704 × 480
VGA output	1-ch VGA output, resolution: 1280 × 1024 /60Hz, 1280 × 720 /60Hz, 1024 × 768 /60 Hz
HDMI output	1-ch HDMI output, resolution: 1080P (1920 × 1080) /60 Hz, 1080I (1920 × 1080) /50 Hz, 1600 × 1200 /60 Hz, 1280 × 1024 /60 Hz, 1280 × 720 /60 Hz, 1024 × 768 /60 Hz
DVI output	1-ch DVI output, resolution: 1080P (1920 × 1080) /60 Hz, 1080I (1920 × 1080) /60 Hz, 1080P (1920 × 1080) /50 Hz, 1080I (1920 × 1080) /50 Hz, 1600 × 1200 /60 Hz, 1280 × 1024 /60 Hz, 1280 × 720 /60 Hz, 1024 × 768 /60 Hz
Audio output	2-ch, RCA (2.0 ~ 2.4 Vp-p, 600 Ω)
<b>Audio/Video Decoding</b>	
IP video input	H.264 / MPEG4
Video decoding resolution	1080P (1920 × 1080), 720P (1280 × 720), UXGA (1600 × 1200), SVGA (800 × 600), VGA (640 × 480)
Video decoding channels	1-ch at 1080P (1920 × 1080) / 2-ch at 720P (1280 × 720) / 4-ch at 4CIF resolution
Multi-division Display Mode	1/2/4
Frame rate	25 fps (P) /30 (N) fps
Audio compression	OggVorbis
<b>External Interface</b>	
Network interface	1 RJ45 10/100/1000 Mbps self-adaptive Ethernet interface
Serial interface	1 RS485 and 1 RS232 serial interface
Voice talk input	1-ch, RCA (2.0 ~ 2.4 Vp-p, 1 kΩ)
Alarm in	4
Alarm out	2
<b>General</b>	
Power Supply	12 VDC
Power Consumption	≤ 12 W
Working Temperature	-10 °C ~ +55 °C (14 °F ~ 131 °F)
Working Humidity	10% ~ 90%
Dimensions (W × D × H)	198 × 123 × 39 mm
Weight (without HDD)	≤ 1.5 kg

# DS-6001FI Encoder & Decoder Server



## Key Features

- High performance DSP hardware compression
- Up to 4CIF decoding
- Up to 4CIF encoding

## Specifications

	DS-6001FI
<b>Video/Audio input</b>	
Video Standard	H.264
Audio Standard	OggVorbis
Video input	1-ch BNC (1.0 Vp-p, 75 Ω)
Voice talk input	1-ch RCA (2.0 Vp-p, 1 kΩ)
<b>Video/Audio output</b>	
Decoding resolution	4CIF / DCIF / 2CIF / CIF / QCIF
Video output	1-ch BNC (1.0 Vp-p, 75 Ω)
Frame rate	4CIF: 25 fps (P) / 30 fps (N)
Stream type	Video, Video & Audio
Video bit rate	32 Kbps ~ 2 Mbps, or user defined (Max. 8 Mbps)
Audio output	1 RCA output linear electrical level, 600 Ω
<b>External interface</b>	
Communication interface	1 RJ45 10M/100M self-adaptive Ethernet interface 1 RJ45 RS-232 port 1 RJ45 RS-485 port
Alarm in	2
Alarm out	2
<b>Others</b>	
Power supply	12V DC
Consumption	≤ 20W
Working temperature	-10 °C ~ +55 °C (14 °F ~ 131 °F)
Working humidity	10% ~ 90%
Dimensions (W × D × H)	199 x 122 x 42 mm
Weight(without HDD)	≤ 2kg

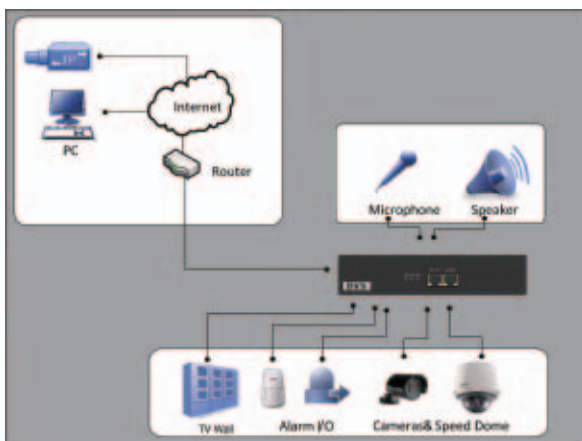

Rear Panel of DS-6101FI

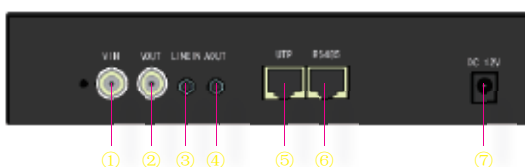

1. Video input
2. Video output
3. Line In
4. Audio output
5. UTP ethernet interface
6. RS-485 serial interface
7. Power supply

# DS-6301/6304/6308DI Decoder Server



## Key Features

- H.264/MPEG4 video compression
- Up to 720P resolution decoding
- Voice talk function
- SADP(IP finder), DHCP, NTP and RTP network protocols

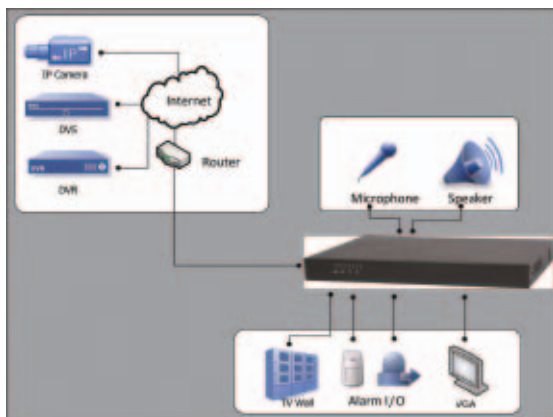

## Specifications

	DS-6301DI	DS-6304DI	DS-6308DI
<b>Video/Audio input</b>			
Voice talk input	1-ch, BNC (2.0 Vp-p, 1 kΩ)		
<b>Video/Audio output</b>			
VGA output	1-ch	2-ch	4-ch
	Resolution: 1280×1024 /60 Hz, 1280×720 /60 Hz, 1024×768 /60 Hz		
Video output	1-ch BNC (1.0 Vp-p, 75 Ω)	4-ch BNC (1.0 Vp-p, 75 Ω)	8-ch BNC (1.0 Vp-p, 75 Ω)
Decoding resolution	720P / 4CIF / DCIF / 2CIF / CIF / QCIF		
Frame rate	720P: 25 fps (P) / 30 fps (N)		
Audio output	1-ch, BNC (Linear, 600 Ω)	4-ch, BNC (Linear, 600 Ω)	8-ch, BNC (Linear, 600 Ω)
Stream type	Video, Video & Audio		
<b>External interface</b>			
Network interface	1, RJ45 10M/100M self-adaptive Ethernet interface		
Serial interface	1 RS-232 interface (for parameters configuration, maintenance, transparent channel); 1 RS-485 interface (for PTZ control)		
Alarm in	8		
Alarm out	8		
<b>General</b>			
Power supply	12 VDC		
Consumption	≤ 40 W		
Working temperature	-10 °C ~ +55 °C (14 °F ~ 131 °F)		
Working humidity	10% ~ 90%		
Dimensions (W × D × H)	440 x 44.5 x 320 mm		
Weight(without HDD)	≤ 5 kg		

Rear Panel of DS-6308DI



- |                       |                  |
|-----------------------|------------------|
| 1. Video/audio out    | 7. LAN           |
| 2. Line in            | 8. RS-485        |
| 3. Line out           | 9. Alarm in      |
| 4. Audio-1 to audio-4 | 10. Alarm out    |
| 5. Vga                | 11. Power switch |
| 6. RS232              | 12. GND          |

# DS-1002KI RS-485 Keyboard



## Key Features

- Incorporate all DVR front panel functions
- Control DVR and PTZ separately
- Support DVR and keyboard cascading
- 2D joystick

## Specifications

DS-1002KI	
<b>External Interface</b>	
Communication interface	RS-485
<b>Others</b>	
Control mode	RS-485 half-duplex mode, baud rate: 1200 ~ 19200 bps
<b>General</b>	
LCD screen	122 x 32 mm
Joystick	2D
Max. cable length	1200m
Power supply	12 VDC
Working temperature	-10 °C ~ +55 °C (14 °F ~ 131 °F)
Working humidity	10% ~ 90%
Dimensions (W x D x H)	300 x 180 x 86 mm
Weight	3.2 kg



# DS-1003KI RS-485 Keyboard



## Key Features

- Incorporate all DVR front panel functions
- Control DVR and PTZ separately
- Support DVR and keyboard cascading
- 3D joystick

## Specifications

DS-1003KI	
<b>External Interface</b>	
Communication interface	RS-485
<b>Others</b>	
Control mode	RS-485 Half-duplex Mode, Baud Rate: 1200 ~ 19200 bps
<b>General</b>	
LCD screen	128 x 64 mm
Joystick	3D
Max. cable length	1200 m
Power supply	12 VDC
Working temperature	-10 °C ~ +55 °C (14 °F ~ 131 °F)
Working humidity	10% ~ 90%
Dimensions (W x D x H)	360 x 200 x 108 mm
Weight	3.3 kg

# DS-1100KI Network Keyboard



## Key Features

- 7" TFT touch screen at 800×480 resolution
- Speed dome, video decoder & DVR control
- 1-ch HD video stream decoding at 1080p
- Support 15 users, and each can operate up to 256 devices
- USB 2.0 interface for video backup

## Specifications

DS-1100KI	
<b>Audio Input/Output</b>	
Line in	1-ch, 3.5 mm connector (2.0 Vp-p, 1 kΩ)
Audio out	1-ch, 3.5 mm connector (Linear, 560 Ω)
<b>External Interface</b>	
Network interface	1 RJ45 10M/100M/1000M self-adaptive Ethernet interface
RS-232 interface	1 RS-232 interface (for parameters configuration and maintenance)
RS-485 interface	1 RS-485 interface
USB interface	1, USB2.0 (for data storage and device upgrade)
<b>General</b>	
LCD	Resolution: 800 × 480
Power supply	12 VDC
Power consumption	≤ 15W
Working temperature	-10 °C ~ +55 °C (14 °F ~ 131 °F)
Working humidity	10% ~ 90%
Dimensions (W × D × H)	110 × 193 × 435 mm
Weight	2 kg

# COMPRESSION CARD

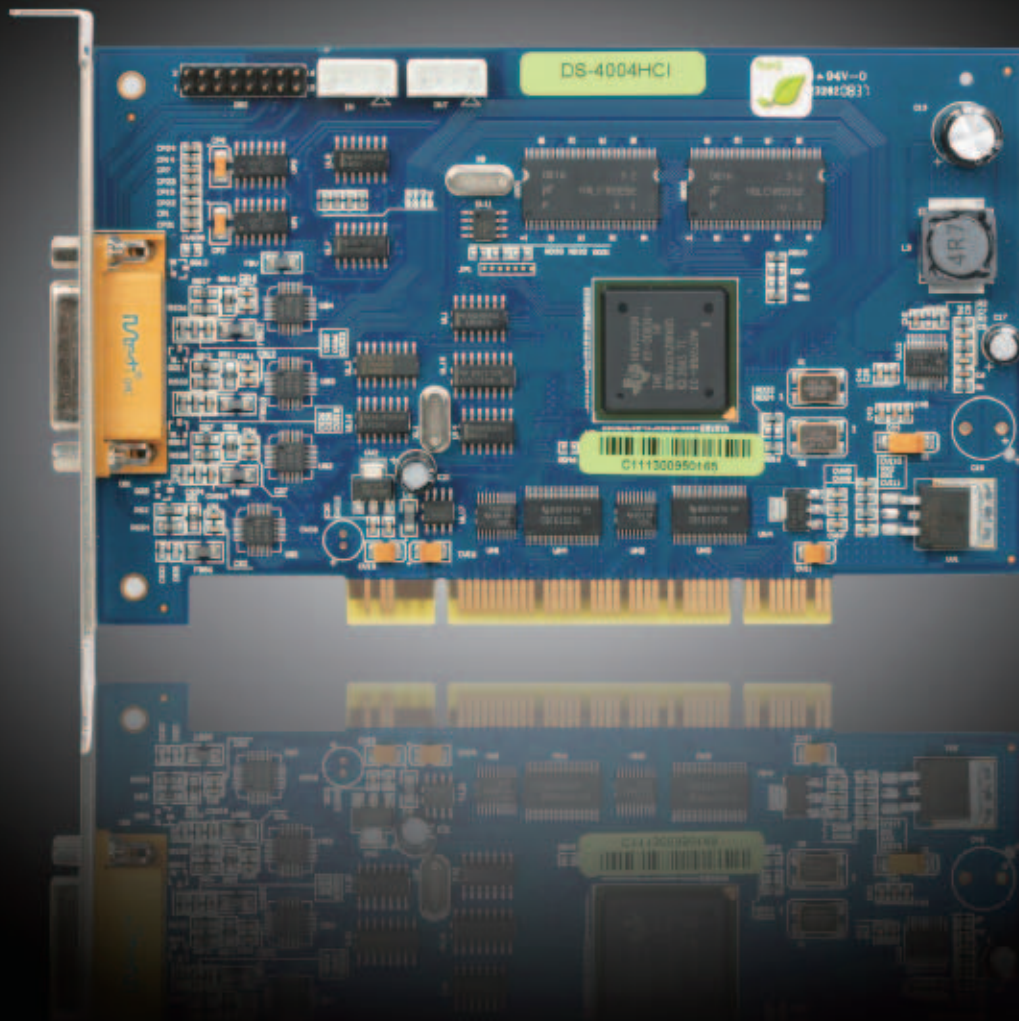

# DS-4004/4008/4016HCI Compression Card



## Key Features

- H.264 (MPEG-4/Part 10) real-time video compression
- Up to 4CIF real-time recording
- PCI 2.2 standard
- Windows 2000/XP/2003/Vista and Linux operating system
- Provide full SDK and demo source code
- Motion detection

## Specifications

	DS-4004HCI	DS-4008HCI	DS-4016HCI
<b>Video/Audio input</b>			
Video compression	H.264		
Video input	4-ch	8-ch	16-ch
Video input interface	BNC (1.0 Vp-p, 75 Ω)		
Audio compression	OggVorbis, 16 Kbps		
Audio input	4-ch	8-ch	16-ch
Audio input interface	BNC(2.0 Vp-p, 1 kΩ)		
<b>Video/Audio output</b>			
Preview resolution	4CIF real time		
Compression resolution	4-ch CIF / 2CIF real time Or 2-ch 4CIF / DCIF real time Or 4-ch DCIF / 4CIF not real time	8-ch CIF / 2CIF real time Or 4-ch 4CIF / DCIF real time Or 8-ch DCIF / 4CIF not real time	16-ch CIF / 2CIF real time Or 8-ch 4CIF / DCIF real time Or 16-ch DCIF / 4CIF not real time
Video bit rate	32 Kbps ~ 2 Mbps		
Stream type	Video, Video & Audio		
Dual stream	Support		
<b>General</b>			
Power consumption	< 3.5 W	< 7 W	< 22 W
Working temperature	-10 °C ~ +50 °C(14 °F ~ 122 °F)		
Working humidity	10% ~ 90%		
Dimensions	155 x 95 mm(6.10" x 3.74")	201 x 109 mm(7.91" x 4.29")	250 x 106 mm(9.84" x 4.17")
<b>System requirements</b>			
OS	Windows 2000/XP/Server 2003/7/Vista, Fedora 8		
CPU	Intel series		
Motherboard	Based on Intel 845/865/915/925/945/965/G31/G33/P31/P35/P43/P45 Series. Please refer to the compatible list on the Hikvision website		
Memory	256MB or above		
Display Adapter	NVIDIA GeForce Mx400/440/4000 or above series FX 5200/5600 GeForce 6600 or above series ATI Radeon 7000/7500/8500/9000/9200/9550/9600 or above series ATI X300/X550/X700/X1300/X1600 or above series Intel 845G/865G/915G integrated Graphics Controller Please refer to the compatible list on Hikvision website		

# DS-4008/4016HSI Compression Card

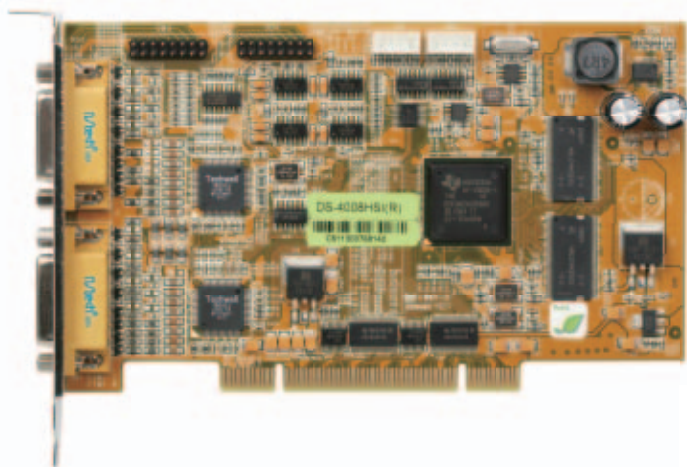

## Key Features

- H.264 (MPEG-4/Part 10) real-time video compression
- Up to real-time 4CIF display resolution
- PCI 2.2 standard
- Windows 2000/XP/2003/Vista and Linux operating system
- Motion detection
- OSD, LOGO, and MASK overlay

## Specifications

	DS-4008HSI	DS-4016HSI
<b>Video/Audio input</b>		
Video compression	H.264	
Video input	8-ch	16-ch
Video input interface	BNC (1.0 Vp-p, 75 Ω)	
Audio compression	OggVorbis, 16Kbps	
Audio input	8-ch	16-ch
Audio input interface	BNC(2.0 Vp-p, 1 kΩ)	
<b>Video/Audio output</b>		
Preview resolution	4CIF real time	
Compression resolution	8-ch CIF real time Or 8-ch 2CIF / DCIF / 4CIF not real time	16-ch CIF real time Or 16-ch 2CIF / DCIF / 4CIF not real time
Video bit rate	32 Kbps ~ 2 Mbps	
Stream type	Video, Video & Audio	
<b>General</b>		
Power consumption	< 4.5 W	< 9 W
Working temperature	-10 °C ~ +50 °C (14 °F ~ 122 °F)	
Working humidity	10% ~ 90%	
Dimensions	178 x 99 mm (7.01" x 3.90")	198 x 100 mm(7.80" x 3.94")
<b>System requirements</b>		
OS	Windows 2000/XP/Server 2003/7/Vista, Fedora 8	
CPU	Intel series	
Motherboard	Based on Intel 845/865/915/925/945/965/G31/G33/P31/P35/P43/P45 Series. Please refer to the compatible list on the Hikvision website	
Memory	256MB or above	
Display adapter	NVIDIA GeForce Mx400/440/4000 or above series FX 5200/5600 GeForce 6600 or above series ATI Radeon 7000/7500/8500/9000/9200/9550/9600 or above series ATI X300/X550/X700/X1300/X1600 or above series Intel 845G/865G/915G integrated Graphics Controller Please refer to the compatible list on Hikvision website	

# DS-4216HCI Compression Card

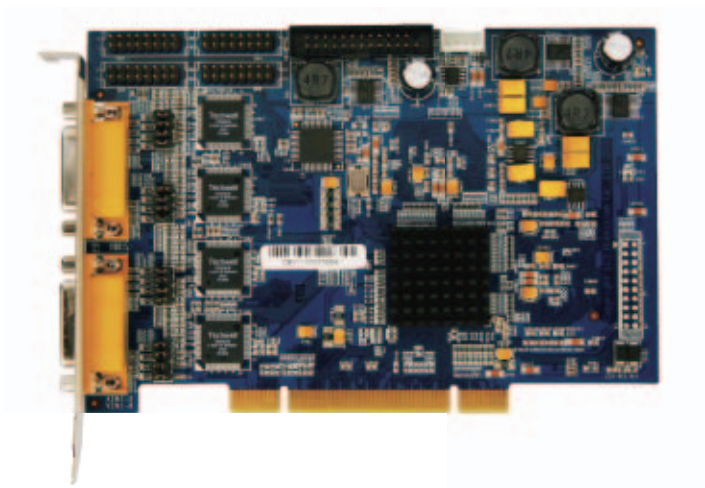

## Key Features

- Adopts high-efficiency video processing chips
- Standard H.264 video codec
- CIF real-time audio/video capturing and encoding
- Multiple cards plugged in PC (support up to 40ch cameras input for 1 PC)
- Built-in motion detect
- OSD, LOGO and mask area settings

## Specifications

DS-4216HCI	
<b>Video/Audio input</b>	
Video compression	H.264
Video input	16-ch
Video input interface	BNC (1.0 Vp-p, 75 Ω)
Audio compression	OggVorbis
Audio input	16ch, mono
Audio input interface	BNC (2 Vp-p, 1 kΩ, volume adjust range: 83DB)
<b>Video/Audio output</b>	
Preview resolution	4CIF real time
Compression resolution	CIF / QCIF real time; 4CIF / 2CIF not real time
Video bit rate	32 k ~ 2 M (CIF), 32 k ~ 4M (4CIF) (Unit:bps)
Sampling rate	8 KHz
Audio recording bit rate	64 kbps
Dual stream	Support
<b>General</b>	
PCI standard	PCI 2.2
Power consumption	< 8.5 W
Working temperature	-10 °C ~ +50 °C (14 °F~ 122 °F)
Working humidity	10%~90%
<b>System requirements</b>	
Dimensions	162 x 101 mm (6.38" x 3.98")
OS	Windows 2000/XP/2003/Vista/7/Linux
CPU	Intel C4/P4/Core2/Core4 Series
Motherboard	Based on Intel 845/865/915/925/945/965/G31/G33/P31/P35/P43/P45 Series. Please refer to the compatible list on the Hikvision website
Memory	512MB or above
Display Adapter	ATI Radeon X1650/X1600/X1550/X1300/X800/X600/X550/HD2400/HD2600 ATI Radeon 7000/7200/7500/8500 /9000/9200 /9500/9600 NVIDIA GeForce 8600GT/8500GT/8400GS/7600/7300LE/6600LE/6200LE Please refer to the compatible list on the Hikvision website

# DS-4208/4216HFVI Compression Card

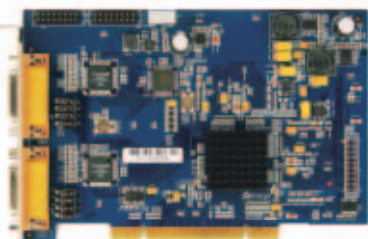

DS-4208HFVI

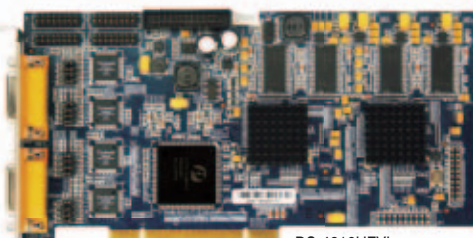

DS-4216HFVI

## Key Features

- Extra-low power consumption and high stability
- Standard H.264 video codec
- 4CIF real-time audio/video capturing and encoding
- Multiple cards plugged in PC (up to 40ch cameras input for 1 PC)
- Built-in motion detect
- OSD, LOGO and mask area settings

## Specifications

	DS-4208HFVI	DS-4216HFVI
<b>Video/Audio input</b>		
Video compression	H.264	
Video input	8-ch	16-ch
Video input interface	BNC (1.0 Vp-p, 75 Ω)	
Audio compression	OggVorbis	
Audio input	8ch, mono	16ch, mono
Audio input interface	BNC (2 Vp-p, 1 kΩ, volume adjust range: 83DB)	
<b>Video/Audio output</b>		
Preview resolution	4CIF real time	
Compression resolution	4CIF / 2CIF / CIF / QCIF real time	
Video output	1 channel BNC video output	
Video bit rate	32 k ~ 2 M (CIF), 32 k ~ 4M (4CIF) (Unit: bps)	
Sampling Rate	8 KHz	
Audio Recording Bit Rate	64 kbps	
Dual Stream	Support	
<b>General</b>		
PCI standard	PCI 2.2	
Power consumption	< 7 W	< 14W
Working temperature	-10 °C ~ +50 °C (14 °F ~ 122 °F)	
Working humidity	10%~90%	
Dimensions	162 x 101 mm (6.38" x 3.98")	213 x 101 mm (8.39" x 3.98")
<b>System requirements</b>		
OS	Windows 2000/XP/2003/Vista/7/Linux	
CPU	Intel C4/P4/Core2/Core4 Series	
Motherboard	Based on Intel 845/865/915/925/945/965/G31/G33/P31/P35/P43/P45 Series. Please refer to the compatible list on the Hikvision website	
Memory	512MB or above	
Display Adapter	ATI Radeon X1650/X1600/X1550/X1300/X800/X600/X550/HD2400/HD2600 ATI Radeon 7000/7200/7500/8500 /9000/9200 /9500/9600 NVIDIA GeForce 8600GT/8500GT/8400GS/7600/7300LE/6600LE/6200LE Please refer to the compatible list on the Hikvision website	

# DS-4002/4004MDI+ Encode Card

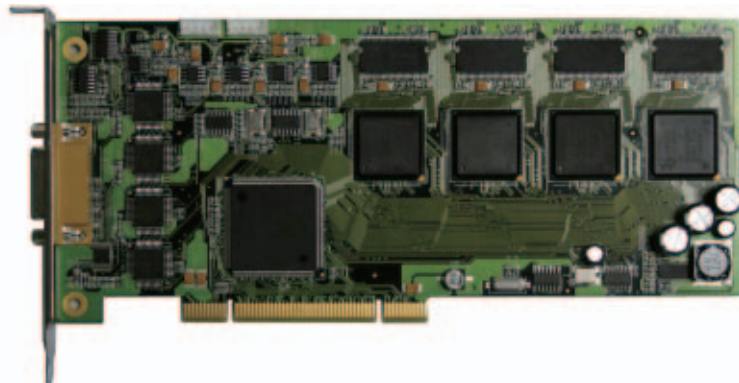

## Key Features

- High performance DSP hardware decompression
- Up to 4-ch video stream at 4CIF resolution, 8-ch video stream at 2CIF resolution or 16-ch video stream at CIF resolution
- Up to 4-ch video & audio output
- Up to 4x4 multiplex windows display
- Picture-In-Picture display









## Specifications





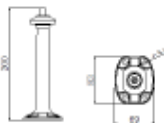
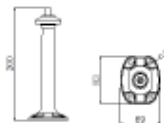
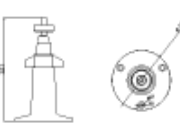

	DS-4002MDI+	DS-4004MDI+
<b>Video/Audio output</b>		
Support Video compression Standard	H.264	
Video Output	2-ch	4-ch
Video Output Interface	BNC (1.0 Vp-p, 75 Ω)	
Video Standard	PAL/NTSC	
Resolution	2-ch 4CIF Or 4-ch DCIF / 2CIF Or 8-ch CIF / QCIF	4-ch 4CIF or 8-ch DCIF / 2CIF or 16-ch CIF / QCIF
Frame rate	PAL: 25 fps; NTSC: 30 fps	
Support audio compression standard	OggVorbis	
Audio output	2-ch PCM, mono	4-ch, mono
Audio output interface	BNC (Linear Level, 600 Ω)	
<b>General</b>		
PCI standard	PCI 2.2	
Power consumption	< 10 w	< 16 w
Dimensions	168 x 101 mm (6.61" x 3.98")	220 x 89 mm (8.66" x 3.50")
<b>System requirements</b>		
OS	Windows 2000/XP/2003/Vista/7/Linux	
CPU	Intel C4/P4/Core2/Core4 Series	
Motherboard	Based on Intel 845/865/915/925/945/965/G31/G33/P31/P35/P43/P45 Series. Please refer to the compatible list on the Hikvision website	
Memory	512MB or above	
Display adapter	ATI Radeon X1650/X1600/X1550/X1300/X800/X600/X550/HD2400/HD2600 ATI Radeon 7000/7200/7500/8500 /9000/9200 /9500/9600 NVIDIA GeForce 8600GT/8500GT/8400GS/7600/7300LE/6600LE/6200LE Please refer to the compatible list on the Hikvision website	

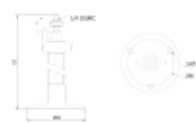
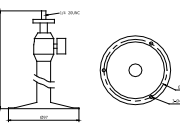







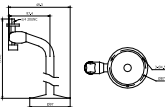
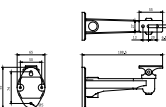
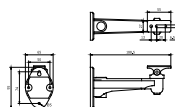
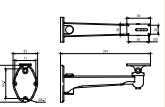
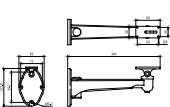
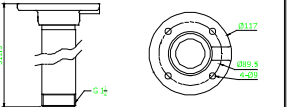



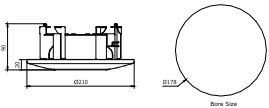
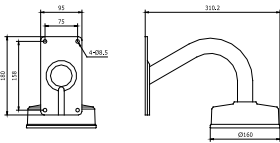
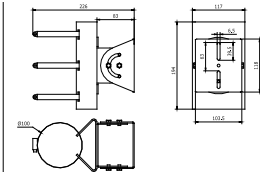
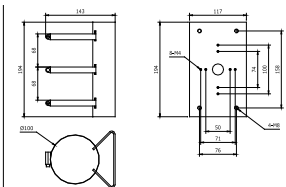

# Accessories





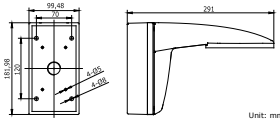
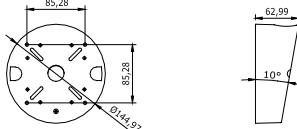
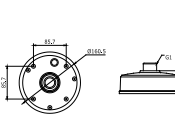
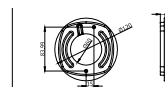

## Camera Bracket

Model						
	DS-1203ZJ (White)	DS-1203ZJ-S (Silver)	DS-1202ZJ (White)	DS-1209ZJ-S (Silver)	DS-1204ZJ-S (Silver)	DS-1204ZJ-B (Black)
Feature	Pendant mount Suitable for box camera, except Infrared camera	Pendant mount Suitable for box camera, except Infrared camera	Pendant mount Suitable for card camera	Pendant mount Suitable for box camera, except Infrared camera	Desktop mount Desktop mounting for box camera	Desktop mount Desktop mounting for box camera
Construction	Aluminum alloy	Aluminum alloy	Aluminum alloy	Aluminum alloy	Aluminum alloy	Aluminum alloy
Weight	130 g (0.29 lbs)	130 g (0.29 lbs)	65g(0.14lbs)	150 g (0.33 lbs)	110 g (0.24 lbs)	110 g (0.24 lbs)
Dimension	Φ 80 × 171 mm (Φ 3.15" × 6.73")	Φ 80 × 171 mm (Φ 3.15" × 6.73")	Φ 80×115 (Φ 3.15"×4.53")	Φ 97 × 232 mm (Φ 3.82" × 9.13")	Height 186 mm MAX (7.32")	Height 186 mm MAX (7.32")
						



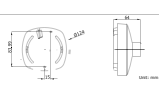
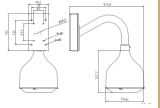

Model						
	DS-1210ZJ-S (Silver)	DS-1212ZJ-S (Silver)	DS-1212ZJ (White)	DS-1213ZJ-S (Silver)	DS-1213ZJ-W (White)	DS-1229ZJ (White)
Feature	Pendant mount Suitable for box camera, except Infrared camera	Indoor wall mount Suitable for box camera, indoor housing	Indoor wall mount Suitable for box camera, indoor housing	Indoor/Outdoor wall mount Suitable for box camera, indoor/outdoor housing	Indoor/Outdoor wall mount Suitable for box camera, indoor/outdoor housing	Vandal-proof wall mount Suitable for DS-2CD753F-E, DS-2CD754F-E, DS-2CD763P(N)F-E, DS-2CD793P(N)F-E, DS-2CD793P(N)FWD-E, DS-2CD733F-E vandal-proof dome camera
Construction	Aluminum alloy	Aluminum alloy	Aluminum alloy	Aluminum alloy	Aluminum alloy	Aluminum alloy
Weight	170 g (0.37 lbs)	360 g (0.79 lbs)	360 g (0.79 lbs)	765 g (1.68 lbs)	765 g (1.68 lbs)	580 g (1.28 lbs)
Dimension	Φ 97 × 312 mm (Φ 3.82" × 12.28")	65 × 95 × 188.5 mm (2.56" × 3.74" × 7.40")	65 × 95 × 188.5 mm (2.56" × 3.74" × 7.40")	83 × 123.9 × 304 mm (3.27" × 4.88" × 11.97")	83 × 123.9 × 304 mm (3.27" × 4.88" × 11.97")	100 × 182.5 × 251 mm (3.94" × 7.19" × 9.88")
						

Model				
	DS-1227ZJ (White) Indoor in-ceiling mount	DS-1217ZJ (White) Vandal-proof wall mount	DS-1214ZJ (White) Pole mount adapter	DS-1215ZJ (White) Pole mount adapter
Feature	Suitable for DS-2CD753F-E, DS-2CD754F-E, DS-2CD763P(N)F-E, DS-2CD793P(N)F-E, DS-2CD793P(N)FWD-E, DS-2CD733F-E vandal-proof dome camera	Suitable for DS-2CD752MF-(I)FB(H), DS-2CD762MF-(I)FB(H) dome camera	Suitable for box camera and housing (Universal adjustment)	Suitable for DS-1212ZJ, DS-1213ZJ, DS-1225ZJ and DS-1226ZJ, DS-1217ZJ, DS-1229ZJ bracket Diameter range: 091 - 114 mm (03.59" - 4.49")
Construction	Sheet Metal and ABS	Aluminum alloy	Aluminum alloy	Aluminum alloy
Weight	540 g (1.19 lbs)	1395 g (3.08 lbs)	1895 g (4.18 lbs)	1205 g (2.66 lbs)
Dimension	Φ210.0 × 90 mm (Φ 8.27" × 3.54") 	95 × 180 × 310.2 mm (3.86" × 7.09" × 12.21") 	117 × 194 × 226 mm (4.61" × 7.64" × 8.90") 	117 × 194 × 143 mm (4.61" × 7.64" × 5.63") 





Model					
	DS-1239ZJ (White) Vandal-proof wall mount	DS-1240ZJ (White) Tilted wall-mount	DS-1233ZJ (White) Pendant mount for dome camera	DS-1234ZJ (White) Electric-box mount	DS-1235ZJ (White) ---
Feature	Suitable for DS-2CD753F-E, DS-2CD754F-E, DS-2CD763P(N)F-E, DS-2CD793P(N)F-E, DS-2CD793P(N)FWD-E, DS-2CD733F-E vandal-proof dome camera	Enlarge the visual angle with 10°, Suitable for DS-2CC5102P(N)-VP(IR)(-H), DS-5173P(N)-VP(IR)(-H), DS-5182P(N)-VP(IR)(-H), DS-5183P(N)-VP(IR)(-H), DS-5185P(N)-VP(IR)(-H), DS-5187P(N)-VP(IR)(-H), DS-5193P(N)-VP(IR)(-H), DS-5195P(N)-VP(IR)(-H) and DS-5197P(N)-VP(IR)(-H)	Suitable for DS-2CD752MF-(I)FB(H), DS-2CD762MF-(I)FB(H) dome camera	Suitable for DS-2CD7133-E and DS-2CD7153-E	---
Construction	Aluminum alloy	Aluminum alloy	Aluminum alloy	ABS plastic	Aluminum alloy
Weight	1060 g (2.34 lbs)	390 g (0.86 lbs)	915 g (2.02 lbs)	25 g (0.06 lbs)	180g(0.26lbs)
Dimension	100 × 182 × 291 mm (3.94" × 7.17" × 11.5") 	Φ 145 × 63 mm (Φ 5.71" × 0.86") 	Φ 120 × 59.8 mm (Φ 4.72" × 2.35") 	Φ 120 × 9 mm (Φ 4.72" × 0.35") 	Φ 124×57 (Φ 4.88"×2.24") 

Model							
	DS-1236ZJ (White)	DS-1242ZJ (White)	DS-1243ZJ (White)	DS-1244ZJ (White)	DS-1651ZJ-S (Silver)	DS-1652ZJ-S (Silver)	DS-1611ZJ-S (Silver)
	Pendant mount for mini-dome camera	Unify Pendant mount for dome camera	Unify Pendant mount for dome camera	Edge-shelter mount	Indoor Pendant mount (30 cm)	Indoor Pendant mount (50 cm)	Indoor wall mount
Feature	Suitable for DS-2CD7133-E and DS-2CD7153-E	Unitary looking	Unitary looking, with electric box	Suitable for DS-2CC5102P(N), DS-2CC5112P(N), DS-2CC5172P(N), DS-2CC5182P(N), DS-2CC5192P(N).	Suitable for indoor 30 cm pendant mounting	Suitable for indoor 50 cm pendant mounting	Suitable for indoor mounting
Construction	Aluminum alloy, ABS plastic	Aluminum alloy	Aluminum alloy	ABS plastic	Aluminum alloy	Aluminum alloy	Aluminum alloy
Weight	205 g (0.45 lbs)	1570 g (3.46 lbs)	1880 g (4.14 lbs)		1015 g (2.24 lbs)	1320 g (2.91 lbs)	1110 g (2.45 lbs)
	Φ 124 × 64 mm (Φ 4.88" × 2.52")	739 × 187 × 122 mm (29.09" × 7.36" × 4.80")	364 × 186 × 182 mm (14.33" × 7.32" × 7.17")	Φ 120 × 12 mm (Φ 4.72" × 0.47")	Φ 117×312.5 (Φ 4.61" × 12.31")	Φ 117×512.5 (Φ 4.61" × 20.19")	97 × 194.1 × 310 (3.82" × 7.64" × 12.20")
Dimension							



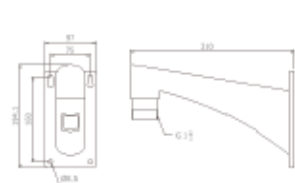
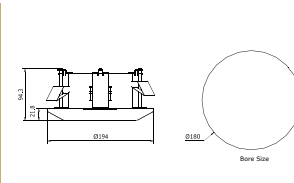
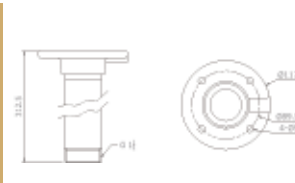
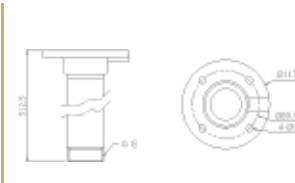

## Camera Power

Model				
	BSW0127-1210002(3C)	BSW0127-1210002	BSW0127-1210002	BSW0127-1210002
	DC 12 V / 1.0 A	DC 12 V / 1.0 A	DC 12 V / 1.0 A	DC 12 V / 1.0 A
Feature	China 2-Pin	British 3-Pin	North American 2-Pin	European 2-Pin



## 4" Speed Dome Bracket

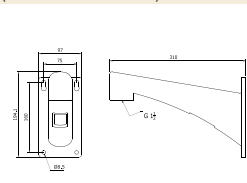
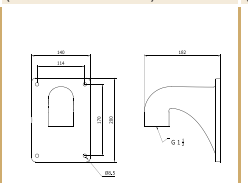
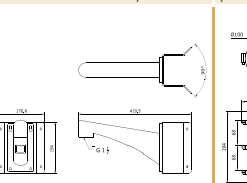
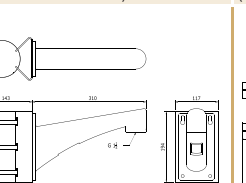
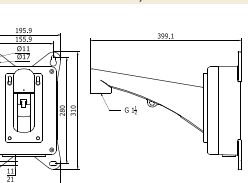

Model				
	DS-1616ZJ	DS-1671ZJ	DS-1653ZJ	DS-1654ZJ
Feature	Indoor long-arm wall mount	Indoor in-ceiling mount	Indoor pendant mount (30 cm)	Indoor pendant mount (50 cm)
Construction	Suitable for indoor wall mounting	Suitable for in-ceiling mounting	Suitable for indoor 30cm pendant mounting	Suitable for indoor 50cm pendant mounting
Weight	Aluminum alloy	Sheet metal and ABS	Aluminum alloy	Aluminum alloy
Weight	1,110 g (2.45 lbs)	500 g (1.1 lbs)	860 g (1.9 lbs)	1,180 g (2.6 lbs)
Dimension	97 × 194.1 × 310 mm (3.82" × 7.64" × 12.20")	Φ 194 × 94.3 mm (Φ 7.64" × 3.71")	Φ 117 × 312.5 (Φ 4.61" × 12.31")	Φ 117 × 512.5 (Φ 4.61" × 20.19")
Dimension				

## 5" Speed Dome Bracket



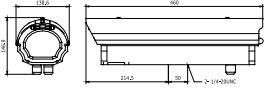
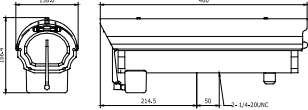
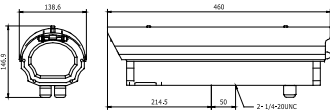

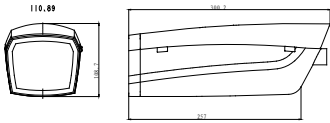
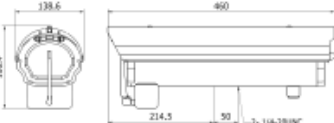

Model					
	DS-1614ZJ	DS-1615ZJ	DS-1633ZJ	DS-1622ZJ	DS-1634ZJ
Feature	Long-arm wall mount	Indoor short-arm wall mount	Suitable for corner mounting	Pole mount	Power box mount
Construction	Suitable for indoor/outdoor wall mounting	Suitable for indoor wall mounting	Aluminum alloy	Suitable for pole mounting Diameter range: Φ 91 - 114 mm (Φ 3.58" - 4.49")	Suitable for indoor/outdoor wall mounting
Weight	Aluminum alloy	Aluminum alloy	Corner mount	Aluminum alloy	Aluminum alloy
Weight	1,070 g (2.36 lbs)	1,015 g (2.24 lbs)	2,675 g (5.9 lbs)	2,000 g (4.41 lbs)	3,770 g (8.31 lbs)
Dimension	97 × 194.1 × 310 mm (3.82" × 7.64" × 12.20")	140 × 200 × 182 mm (5.51" × 7.87" × 7.17")	176.8 × 194 × 419.5 mm (6.96" × 7.64" × 16.52")	117 × 194 × 310 mm (4.61" × 7.64" × 12.20")	209.2 × 310 × 399.1 mm (8.24" × 12.20" × 15.71")
Dimension					

# Camera Housing



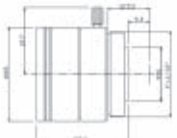

Model			
	DS-1311HZ	DS-1312HZ	DS-1313HZ
Feature	Outdoor camera housing Easy installation	Outdoor camera housing Built-in heater, wiper and fan	Outdoor camera housing Built-in heater and fan
Working Temperature	-10 °C - 60 °C (14 °F - 140 °F)	-40 °C - 70 °C (-40 °F - 158 °F) (the heater and fan activates when there is temperature variance below ±5 °C.)	-40 °C - 70 °C (-40 °F - 158 °F) (the heater and fan activates when there is temperature variance below ±5 °C.)
Power Supply	--	24 V AC ± 10%	24 V AC ± 10%
Power Consumption	--	Heater 50 W, Fan 3 W, Wiper 5 W	Heater 50 W, Fan 3 W
Weather Proof	IP66	IP66	IP66
Construction	Aluminum alloy	Aluminum alloy	Aluminum alloy
Weight	2300 g (5.07 lbs)	2615 g (5.77 lbs)	2415 g (5.32 lbs)
Dimensions	138.6 × 146.9 × 460 mm (5.46" × 5.78" × 18.11") 	138.6 × 166.4 × 460 mm (5.46" × 6.55" × 18.11") 	138.6 × 146.9 × 460 mm (5.46" × 5.78" × 18.11") 

Model		
	DS-1320HZ	DS-1325HZ
Feature	Indoor camera housing Special button for ON/OFF	Built-in heater, wiper and fan Suitable for thermal network camera
Working Temperature	-10 °C - 60 °C (14 °F - 140 °F)	-10 °C - 60 °C (14 °F - 140 °F)(the heater and fan activates when there is temperature variance below ±5 °C.)
Power Supply	--	AC24V
Power Consumption	--	Heater 50W, Fan 3W, Wiper 5W
Weather Proof	--	IP66
Construction	ABC plastic	window: germanium housing: Aluminum alloy
Weight	600 g (1.32 lbs)	2725g(6.01lbs)
Dimensions	300 × 110 × 110 mm (11.81" × 4.33" × 4.33") 	138.6 × 166.4 × 460 mm (5.46" × 6.55" × 18.11") 

# Lens

Model				
	TF0216 Fixed Iris Fixed Focus Lens	TF0412-IR Fixed Iris Fixed Focus IR Lens	TF0612-IR Fixed Iris Fixed Focus IR Lens	TF0812-IR Fixed Iris Fixed Focus IR Lens
Focal Length	2.1mm	4mm	6mm	8mm
Aperture Range	F1.6	F1.2	F1.2	F1.2
Lens Mount	CS	CS	CS	CS
Format	1/3"	1/3"	1/3"	1/3"
Horizontal Angle of View	1/3" 122.4°	1/3" 59°	1/3" 43.6°	1/3" 33.4°
	1/4" 85°	1/4" 44°	1/4" 32.7°	1/4" 25.05°
Min.Working Distance	0.1 m	0.2 m	0.2 m	0.2 m
Weight	55 g	36 g	39 g	39 g
Application	Within 5 meters	Within 10 meters	Within 15 meters	Within 20 meters
Dimension	Φ30 × 20.7 mm (Φ 1.18" × 0.81")	Φ28 × 27.3 mm (Φ 1.10" × 1.07")	Φ28 × 30 mm (Φ 1.10" × 1.18")	Φ28 × 30 mm (Φ 1.10" × 1.18")
				

Model					
	TV0309D-IR Auto Iris Vari-focal IR Lens	TV3508M Manual Iris Vari-focal Lens	TV2713D-IR Auto Iris Vari-focal IR Lens	TV0550D-IR Auto Iris Vari-focal IR Lens	TV0660M-IR Manual Iris Vari-focal IR Lens
Focal Length	3 ~ 9 mm	3.5 ~ 8 mm	2.7 ~ 13 mm	5 ~ 50 mm	6 ~ 60 mm
Aperture Range	F1.2-C	F1.4-C	F1.3-C	F1.4-C	F1.6-C
Lens Mount	CS	CS	CS	CS	CS
Format	1/3"	1/3"	1/3"	1/3"	1/3"
Horizontal Angle of View	1/3" 111° ~ 31.6°	1/3" 78° ~ 34°	1/3" 98° ~ 22°	1/3" 49° ~ 5.4°	1/3" 42° ~ 4.5°
	1/4" 69.6° ~ 23.4°	1/4" 58° ~ 26°	1/4" 73.1° ~ 17.1°	1/4" 36.8° ~ 4°	1/4" 32° ~ 3.4°
Min.Working Distance	0.2 m	0.1 m	0.3 m	0.5 m	0.5 m
Iris Control	DC	Manual	DC	DC	Manual
Weight	45 g	105 g	78 g	118 g	108 g
Application	Within 20 meters	Within 20 meters	Within 30 meters	Within 100 meters	Within 100 meters
Dimension	Φ33 × 45.8 mm (Φ 1.30" × 1.80")	Φ33 × 44 mm (Φ 1.30" × 1.73")	Φ38.8 × 59 mm (Φ 1.53" × 2.32")	Φ35.4 × 61 mm (Φ 1.39" × 2.40")	Φ37 × 63.6 mm (Φ 1.46" × 2.50")
					

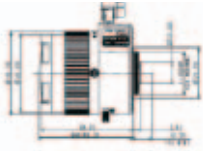
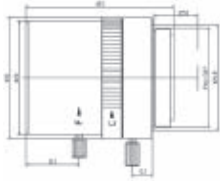
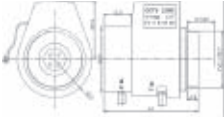
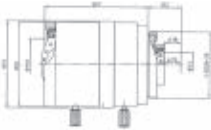
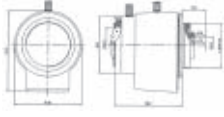
Model					
	TV2712D-MPIR	TV0515M-MPIR	TV0515D-MPIR	HV4510M-MPIR	HV4510D-MPIR
	Auto Iris Vari-focal Megapixel IR Lens	Manual Iris Vari-focal Megapixel IR Lens	Auto Iris Vari-focal Megapixel IR Lens	Manual Iris Vari-focal Megapixel IR Lens	Auto Iris Vari-focal Megapixel IR Lens
Focal Length	2.7-12mm	5 ~ 15 mm	5 ~ 15 mm	4.5 ~ 10 mm	4.5 ~ 10 mm
Aperture Range	F1.2-C	F1.4-C	F1.4-C	F1.6-C	F1.6-C
Lens Mount	CS	CS	CS	CS	CS
Format	1/2.7"	1/3"	1/3"	1/2"	1/2"
Horizontal Angle of View	1/3" 97.2°~24.3°	1/3" 52° ~ 18°	1/3" 41° ~ 19°	1/2" 80.5° ~ 37°	1/2" 80.5° ~ 37°
	1/4" 72.1°~18.4°	1/4" 39° ~ 14°	1/4" 36° ~ 15°	1/3" 60° ~ 29°	1/3" 60° ~ 29°
Min.Working Distance	0.1m	0.2 m	0.2 m	0.1 m	0.1 m
Iris Control	DC	Manual	DC	Manual	DC
Weight	85 g	55 g	58 g	78.6 g	76.7 g
Application	Within 30 meters	Within 50 meters	Within 50 meters	Within 30 meters	Within 30 meters
Dimension					
	Φ48.5×61.3 (Φ1.91"×2.41")	Φ31 × 42.1 mm (Φ1.22" × 1.66")	Φ29 × 38.2 mm (Φ1.14" × 1.50")	Φ33 × 39.7 mm (Φ1.30" × 1.56")	Φ38 × 38.2 mm (Φ1.50" × 1.50")

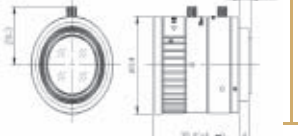
Model				
	MF1214M-MP	MF1614M-MP	MF2514M-MP	MF5018M-MP
	Manual Iris Fixed Focus Megapixel Lens	Manual Iris Fixed Focus I Megapixel Lens	Manual Iris Fixed Focus Megapixel Lens	Manual Iris Fixed Focus Megapixel Lens
Focal Length	12 mm	16 mm	25 mm	50 mm
Aperture Range	F1.4-C	F1.4-C	F1.4-C	F1.8-C
Lens Mount	C	C	C	C
Format	2/3"	2/3"	2/3"	2/3"
Horizontal Angle of View	2/3" 39.9°	2/3" 30.4°	2/3" 19.9°	2/3" 9.2°
	1/2" 29.89°	1/2" 22.62°	1/2" 14.59°	1/2" 7.32°
Min.Working Distance	0.15 m	0.3 m	0.25 m	0.5 m
Iris Control	Manual	Manual	Manual	Manual
Weight	76 g	81 g	83 g	98 g
Application	Within 40 meters	Within 50 meters	Within 80 meters	Within 200 meters
Dimension				
	Φ34 × 32 mm (Φ1.34" × 1.26")	Φ34 × 31.8 mm (Φ1.34" × 1.25")	Φ34 × 35.4 mm (Φ1.34" × 1.39")	Φ34 × 39.7 mm (Φ1.34" × 1.56")



## Hikvision Digital Technology Co., Ltd.

---

### Headquarters

No.700 Dongliu Road, Binjiang District,  
Hangzhou 310052, China  
Tel: +86-571-8807-5998  
Fax: +86-571-8993-5635  
Email: [overseasbusiness@hikvision.com](mailto:overseasbusiness@hikvision.com)

### Hikvision Middle East

Jafza View 18-0901, Jebel Ali  
Free Zone, Dubai 263200, UAE  
Tel: +971-4-8848766  
Fax: +971-4-8848767  
Email: [salesme@hikvision.com](mailto:salesme@hikvision.com)

### Hikvision Hong Kong

Flat C6, 21/F, Gold King Ind Bldg, 35-41  
Tai Lin Pai Road, Kwai Chung  
Tel: +852-2151-1761

### Hikvision USA

908 Canada Court, City of Industry,  
California 91748, USA  
Tel: +1-909-895-0400  
Fax: +1-909-595-2788  
Email: [salesusa@hikvision.com](mailto:salesusa@hikvision.com)

### Hikvision India

2nd Floor, Siddhivinayak Arcade, Akurli  
Cross Road No.1, Near Kandivali East  
Station (Fatak), Kandivali East, Mumbai  
Tel: +91-22-28469900  
Fax: +91-22-28469990  
Email: [sales@pramahikvision.com](mailto:sales@pramahikvision.com)

### Hikvision Europe

Parellaan 24, 2132 WS Hoofddorp,  
The Netherlands  
Tel: +31-23-5542770  
Fax: +31-23-5631112  
Email: [saleseuro@hikvision.com](mailto:saleseuro@hikvision.com)

### Hikvision Russia

194044 Russia, Saint Petersburg,  
Viberleckaya Nabelerinaya 45  
Tel: +7-812-313-19-63  
Fax: +7-812-313-19-63  
Email: [salesru@hikvision.com](mailto:salesru@hikvision.com)